

# CLC502

*CLC502 Clamping, Low Gain Op Amp with Fast 14-bit Settling*



Literature Number: SNOS859B

# CLC502

## Clamping, Low Gain Op Amp with Fast 14-bit Settling

### General Description

The CLC502 is an operational amplifier designed for low gain applications requiring output voltage clamping. This feature allows the designer to set maximum positive and negative output voltage levels for the amplifier – thus allowing the CLC502 to protect downstream circuitry, such as delicate converter systems from destructive transients or signals which would otherwise cause saturation. The overload recovery time of only 8ns permits systems to resume operation quickly after overdrive.

High accuracy systems will also benefit from the CLC502's fast, accurate settling. Settling to 0.0025% in 25ns (32ns guaranteed over temperature), the CLC502 is ideal as the input amplifier in high accuracy (12 bits and above) A/D systems. Unlike most other high speed op amps, the CLC502 is free of settling tails. And, as the settling plots show, settling to 0.01% accuracy is an even faster 18ns typical.

The CLC502 is also useful in other applications which require low gain amplification ( $\pm 1$  to  $\pm 8$ ) and the clamping or overload recovery features. For example, even low resolution imaging circuits, which often have to cope with overloading signal levels, can benefit from clamping and overload recovery.

The CLC502 is available in several versions to meet a variety of requirements. A three-letter suffix determines the version:

Enhanced Solutions (Military/Aerospace)

SMD Number: 5962-91743

\*Space level versions also available.

\*For more information, visit <http://www.national.com/mil>

### Features

- Output clamping with fast recovery
- 0.0025% settling in 25ns (32ns max)
- Low power, 170mW
- Low distortion. -50dBc at 20MHz

### Applications

- Output clamping applications
- High accuracy A/D systems (12-14 bits)
- High accuracy D/A converters
- Pulse amplitude modulation systems

Clamped Pulse Response (8x Overdrive)

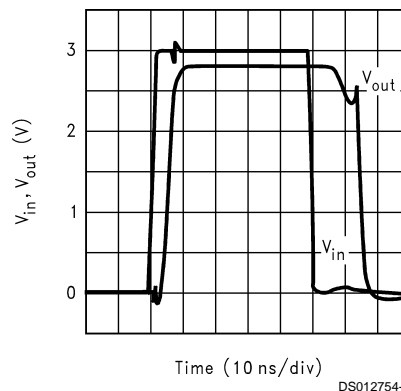

### Connection Diagram

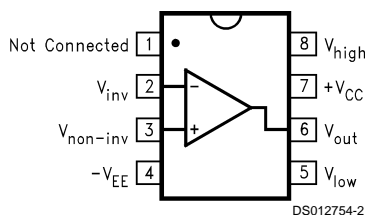

Pinout  
DIP & SOIC

### Ordering Information

| Package            | Temperature Range | Part Number | Package Marking | NSC Drawing |
|--------------------|-------------------|-------------|-----------------|-------------|
| 8-pin Plastic DIP  | -40°C to +85°C    | CLC502AJP   | CLC502AJP       | N08E        |
| 8-pin Plastic SOIC | -40°C to +85°C    | CLC502AJE   | CLC502AJE       | M08A        |

CLC502 Clamping, Low Gain Op Amp with Fast 14-bit Settling

**Absolute Maximum Ratings** (Note 1)

If Military/Aerospace specified devices are required, please contact the National Semiconductor Sales Office/Distributors for availability and specifications.

|                             |              |
|-----------------------------|--------------|
| Supply Voltage ( $V_{CC}$ ) | $\pm 7V$     |
| $I_{OUT}$                   | 60mA         |
| Common Mode Input Voltage   | $\pm V_{CC}$ |
| Junction Temperature        | +150°C       |

Output is short circuit protected to ground, but maximum reliability will be maintained if  $I_{OUT}$  does not exceed...

|                               |                 |
|-------------------------------|-----------------|
| Operating Temperature Range   | -40°C to +85°C  |
| Storage Temperature Range     | -65°C to +150°C |
| Lead Solder Duration (+300°C) | 10 sec          |
| ESD (Human Body Model)        | 1000V           |

**Operating Ratings**

|                    |               |               |  |
|--------------------|---------------|---------------|--|
| Thermal Resistance |               |               |  |
| Package            | $\theta_{JC}$ | $\theta_{JA}$ |  |
| MDIP               | 65°C/W        | 120°C/W       |  |
| SOIC               | 60°C/W        | 140°C/W       |  |

**Electrical Characteristics**

( $A_V = +2$ ,  $V_{CC} = \pm 5V$ ,  $R_L = 100\Omega$ ,  $R_f = 250\Omega$ ,  $V_H = +3V$ ,  $V_L = -3V$ )

| Symbol                                  | Parameter                              | Conditions               | Typ       | Max/Min Ratings (Note 2) |             |             | Units        |
|---|--|--------------------------|-----------|--------------------------|-------------|-------------|--------------|
| Ambient Temperature                     |  | CLC502AJ                 | +25°C     | -40°C                    | +25°C       | +85°C       |              |
| <b>Frequency Domain Performance</b>     |  |                          |           |                          |             |             |              |
| SSBW                                    | -3dB Bandwidth                         | $V_{OUT} < 0.5V_{PP}$    | 150       | >100                     | >110        | >100        | MHz          |
| LSBW                                    |  | $V_{OUT} < 5V_{PP}$      | 65        | >40                      | >40         | >40         | MHz          |
|   | Gain Flatness                          | $V_{OUT} < 0.5V_{PP}$    |           |                          |             |             |              |
| GFPL                                    | Peaking                                | DC to 25MHz              | 0         | <0.4                     | <0.3        | <0.4        | dB           |
| GFPH                                    | Peaking                                | >25MHz                   | 0         | <0.7                     | <0.5        | <0.7        | dB           |
| GFR                                     | Rolloff (Note 5)                       | DC to 50MHz              | 0.5       | <1.0                     | <1.0        | <1.0        | dB           |
| LPD                                     | Linear Phase Deviation                 | DC to 50MHz              | 0.4       | <1.2                     | <1.0        | <1.2        | deg          |
| <b>Time Domain Performance</b>          |  |                          |           |                          |             |             |              |
| TRS                                     | Rise and Fall Time                     | 0.5V Step                | 2.7       | <3.5                     | <3.2        | <3.5        | ns           |
| TRL                                     |  | 5V Step                  | 5.0       | <8                       | <8          | <8          | ns           |
| TS14                                    | Settling Time to $\pm 0.0025\%$        | 2V Step                  | 25        | <32                      | <32         | <32         | ns           |
| TSP                                     | $\pm 0.01\%$                           | 2V Step                  | 18        | <25                      | <25         | <25         | ns           |
| TSS                                     | $\pm 0.1\%$                            | 2V Step                  | 10        | <15                      | <15         | <15         | ns           |
| OS                                      | Overshoot                              | 0.5V Step                | 0         | <10                      | <10         | <10         | %            |
| SR                                      | Slew Rate                              |                          | 800       | >500                     | >500        | >500        | V/ $\mu$ s   |
| <b>Distortion And Noise Performance</b> |  |                          |           |                          |             |             |              |
| HD2                                     | 2nd Harmonic Distortion                | $2V_{PP}$ , 20MHz        | -50       | <-38                     | <-43        | <-43        | dBc          |
| HD3                                     | 3rd Harmonic Distortion                | $2V_{PP}$ , 20MHz        | -60       | <-53                     | <-53        | <-53        | dBc          |
|   | Equivalent Input Noise                 |                          |           |                          |             |             |              |
| SNF                                     | Noise Floor                            | >1MHz                    | -157      | <-155                    | <-155       | <-155       | dBm<br>(1Hz) |
| INV                                     | Integrated Noise                       | 1MHz to 150MHz           | 40        | <49                      | <49         | <49         | $\mu$ V      |
| DG                                      | Differential Gain (Note 4)             |                          | 0.01      | -                        | -           | -           | %            |
| DP                                      | Differential Phase (Note 4)            |                          | 0.05      | -                        | -           | -           | deg          |
| <b>Clamp performance</b>                |  |                          |           |                          |             |             |              |
| OVC                                     | Overshoot in Clamp                     | 2x Overdrive             | 5         | -                        | <10         | -           | %            |
| TSO                                     | Overload Recovery from Clamp           | 2x Overdrive             | 8         | <15                      | <15         | <15         | ns           |
| VOC                                     | Clamp Accuracy (Note 3)                | 2x Overdrive             | $\pm 0.2$ | < $\pm 0.3$              | < $\pm 0.3$ | < $\pm 0.3$ | V            |
| ICL                                     | Input Bias Current on $V_H$ , or $V_L$ |                          | 20        | <75                      | <35         | <35         | $\mu$ A      |
| CBW                                     | -3dB Bandwidth                         | $V_L$ or $V_H = 2V_{PP}$ | 50        | -                        | -           | -           | MHz          |
| CMC                                     | Clamp Voltage Range                    | $V_H$ or $V_L$           |           | < $\pm 3.0$              | < $\pm 3.3$ | < $\pm 3.3$ | V            |
| <b>Static, DC Performance</b>           |  |                          |           |                          |             |             |              |
| VIO                                     | Input Offset Voltage (Note 3)          |                          | 0.5       | <2.6                     | <1.6        | <2.8        | mV           |

## Electrical Characteristics (Continued)

( $A_V = +2$ ,  $V_{CC} = \pm 5V$ ,  $R_L = 100\Omega$ ,  $R_f = 250\Omega$ ,  $V_H = +3V$ ,  $V_L = -3V$ )

| Symbol                           | Parameter                       | Conditions    | Typ        | Max/Min Ratings (Note 2) |            |            | Units            |
|----------------------------------|---------------------------------|---------------|------------|--------------------------|------------|------------|------------------|
| <b>Static, DC Performance</b>    |                                 |               |            |                          |            |            |                  |
| DVIO                             | Average Temperature Coefficient |               | 3          | <12                      | –          | <12        | $\mu V/^\circ C$ |
| IBN                              | Input Bias Current (Note 3)     | Non-Inverting | 10         | <45                      | <25        | <35        | $\mu A$          |
| DIBN                             | Average Temperature Coefficient |               | 100        | <250                     | –          | <100       | $nA/^\circ C$    |
| IBI                              | Input Bias current (Note 3)     | Inverting     | 10         | <50                      | <30        | <40        | $\mu A$          |
| DIBI                             | Average Temperature Coefficient |               | 100        | <250                     | –          | <100       | $nA/^\circ C$    |
| PSRR                             | Power Supply Rejection Ratio    |               | 68         | >55                      | >60        | >60        | dB               |
| CMRR                             | Common Mode Rejection Ratio     |               | 65         | >55                      | >60        | >60        | dB               |
| ICC                              | Supply Current (Note 3)         | No Load       | 17         | <23                      | <23        | <23        | mA               |
| <b>Miscellaneous Performance</b> |                                 |               |            |                          |            |            |                  |
| RIN                              | Non-Inverting Input             | Resistance    | 150        | >50                      | >85        | >85        | k $\Omega$       |
| CIN                              |                                 | Capacitance   | 35         | <5.5                     | <5.5       | <5.5       | pF               |
| RO                               | Output Impedance                | at DC         | 0.1        | <0.2                     | <0.2       | <0.2       | $\Omega$         |
| CMIR                             | Common Mode Input Range         |               | 3.0        | >2.0                     | >2.5       | >2.5       | V                |
| VO                               | Output Voltage Range            | No Load       | $\pm 3.5V$ | $>\pm 3.0$               | $>\pm 3.2$ | $>\pm 3.2$ | V                |
| IO                               | Output Current                  |               | $\pm 55$   | $>\pm 25$                | $>\pm 45$  | $>\pm 45$  | mA               |

**Note 1:** "Absolute Maximum Ratings" are those values beyond which the safety of the device cannot be guaranteed. They are not meant to imply that the devices should be operated at these limits. The table of "Electrical Characteristics" specifies conditions of device operation.

**Note 2:** Min/max ratings are based on product characterization and simulation. Individual parameters are tested as noted. Outgoing quality levels are determined from tested parameters.

**Note 3:** AJ-level: spec. is 100% tested at +25°C.

**Note 4:** Differential gain and phase measure at  $A_V = +2V$ ,  $R = 250\Omega$

**Note 5:**  $R_L = 150\Omega$ , 1V<sub>PP</sub> equivalent video signal, 0-100 IRE, 40 IRE<sub>PP</sub> 0 IRE = 0 volts, at 75 $\Omega$  load and 3.58 MHz

## Typical Performance Characteristics ( $T_A = 25^\circ$ , $A_V = +2$ , $V_{CC} = \pm 5V$ , $R_L = 100\Omega$ , $R_f = 250\Omega$ , $V_H = +3V$ , $V_L = -3V$ )

### Non-Inverting Frequency Response

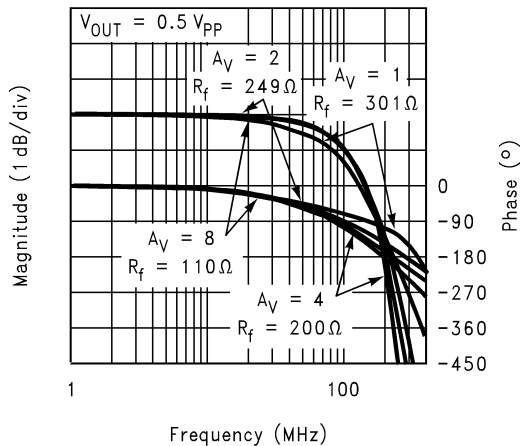

### Inverting Frequency Response

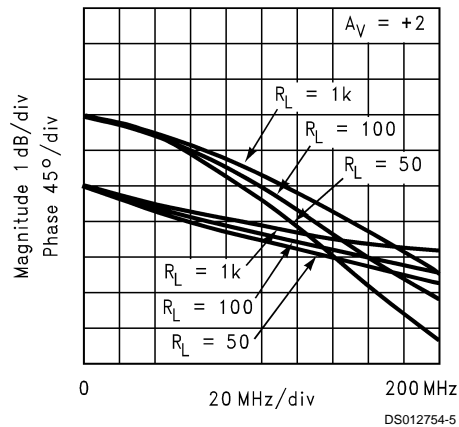

**Typical Performance Characteristics** ( $T_A = 25^\circ$ ,  $A_V = +2$ ,  $V_{CC} = \pm 5V$ ,  $R_L = 100\Omega$ ,  $R_f = 250\Omega$ ,  $V_H = +3V$ ,  $V_L = -3V$ ) (Continued)

**Frequency Response for Various  $R_L$ s**

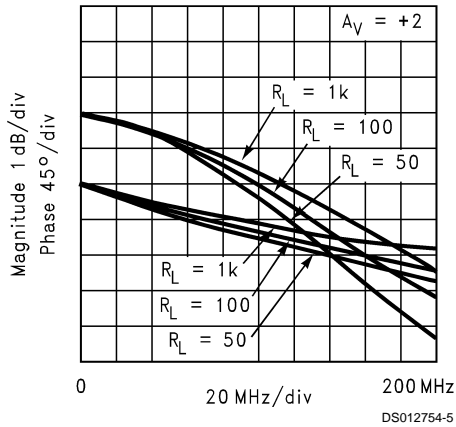

**Open-Loop Transimpedance Gain,  $Z(s)$**

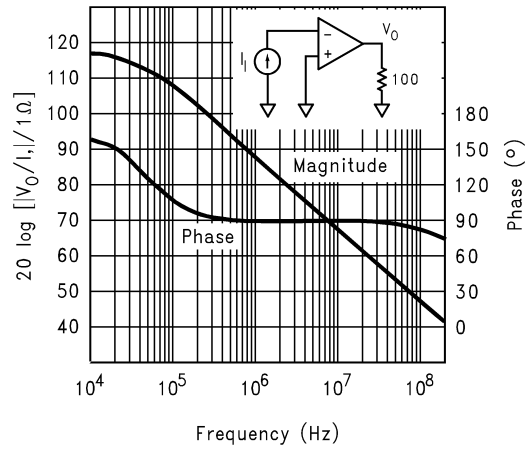

**2nd and 3rd Harmonic Distortion**

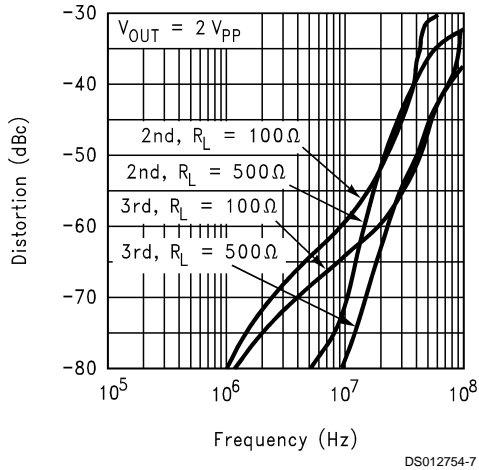

**2-Tone, 3rd Order Intermodulation Intercept**

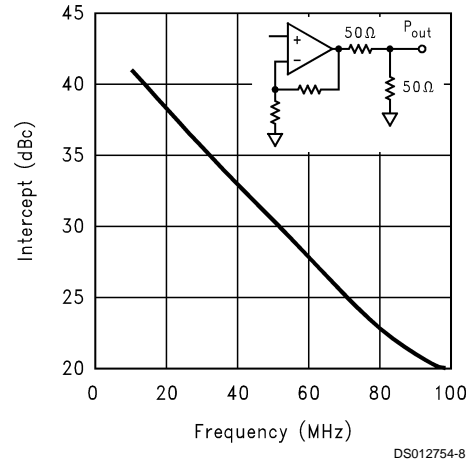

**Equivalent Input Noise**

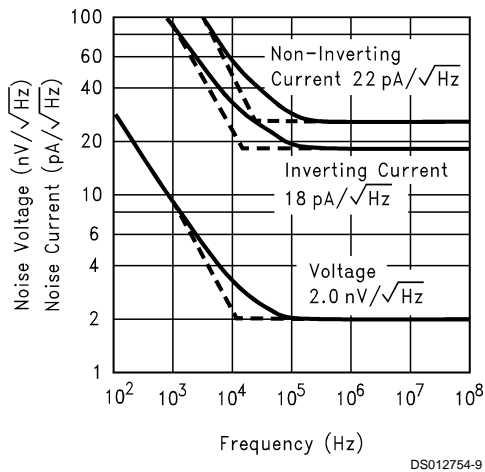

**CMRR and PSRR**

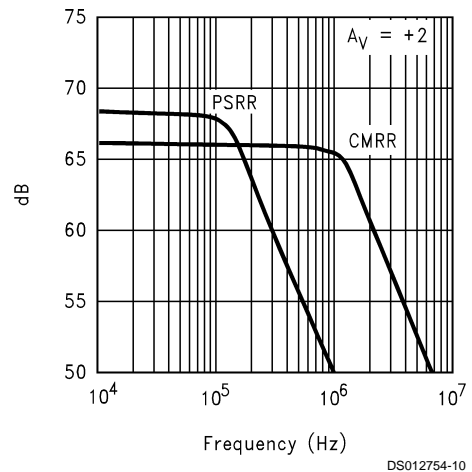

**Typical Performance Characteristics** ( $T_A = 25^\circ$ ,  $A_V = +2$ ,  $V_{CC} = \pm 5V$ ,  $R_L = 100\Omega$ ,  $R_f = 250\Omega$ ,  $V_H = +3V$ ,  $V_L = -3V$ ) (Continued)

**Clamped Pulse Response (8x Overdrive)**

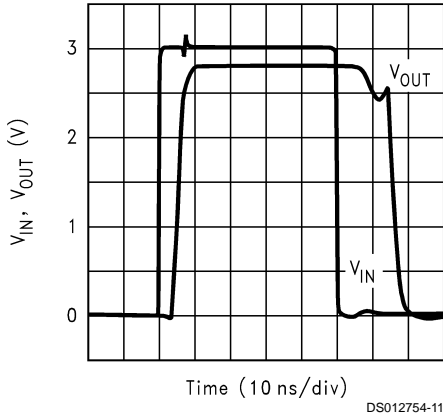

**Setting, Clamped (4x overdrive)**

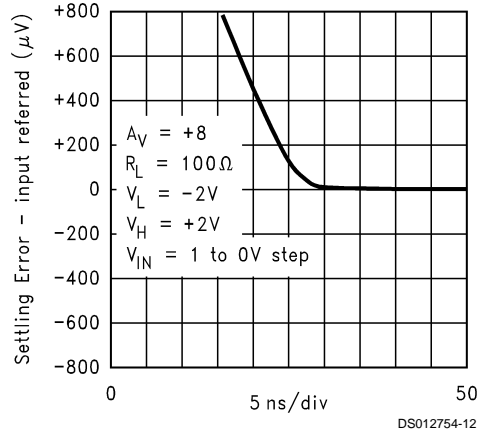

**Long-Term Settling, Clamped (4x overdrive)**

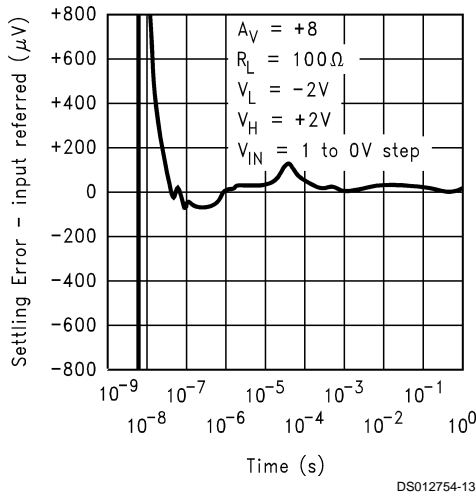

**Nonlinearity Near Clamp Voltage**

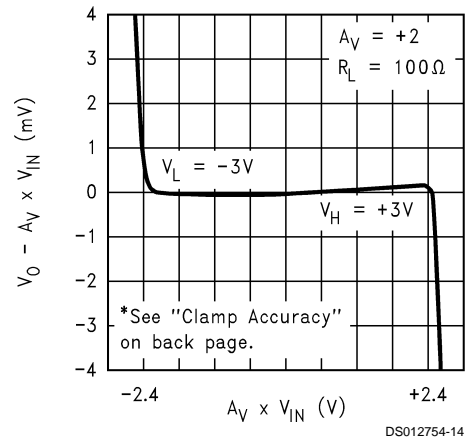

**Settling, Unclamped**

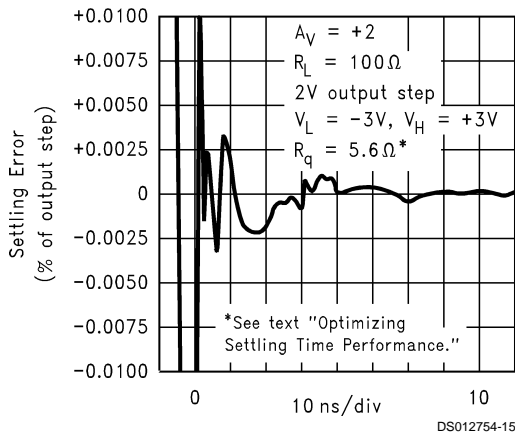

**Long-Term Settling, Unclamped**

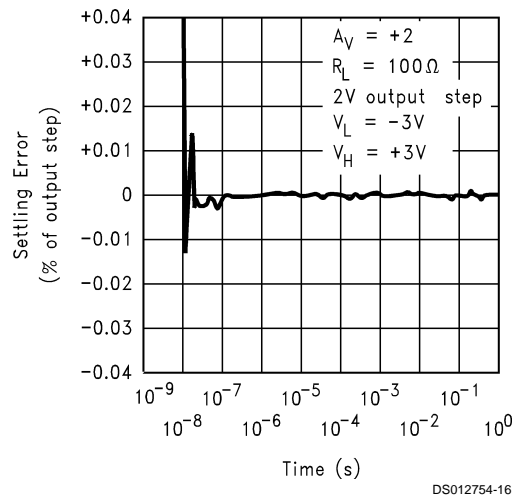

**Typical Performance Characteristics** ( $T_A = 25^\circ$ ,  $A_V = +2$ ,  $V_{CC} = \pm 5V$ ,  $R_L = 100\Omega$ ,  $R_f = 250\Omega$ ,  $V_H = +3V$ ,  $V_L = -3V$ ) (Continued)

**Settling Time vs. Capacitive Load**

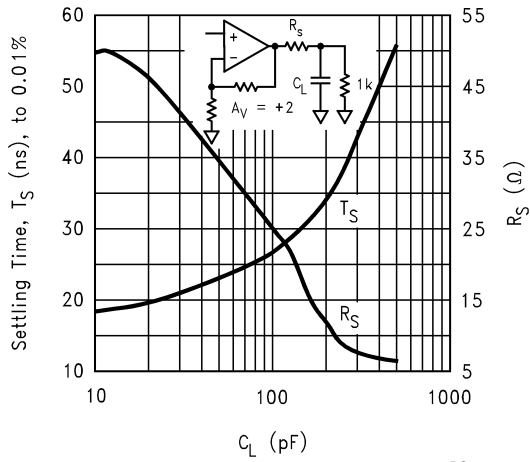

**Application Division**

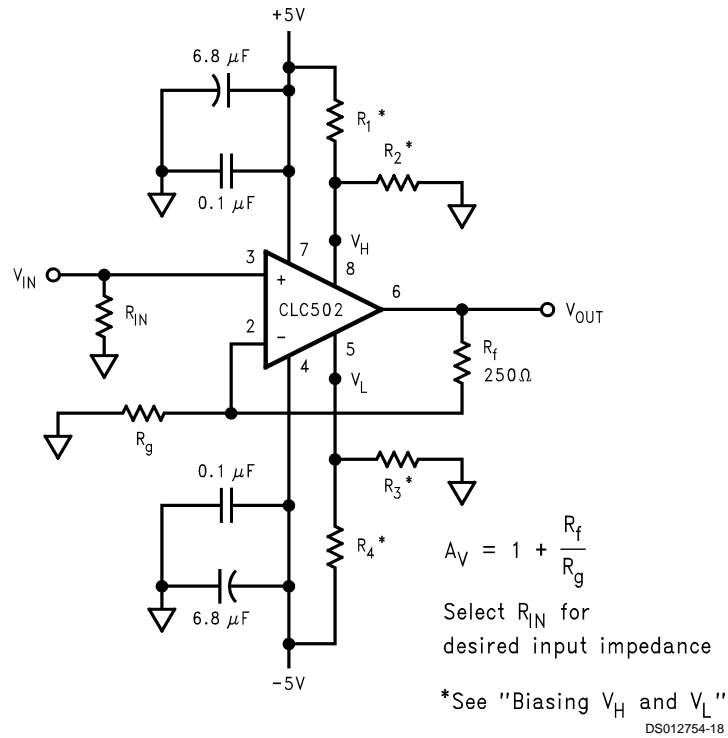

**FIGURE 1. Recommended Non-Inverting Gain Circuit**

Application Division (Continued)

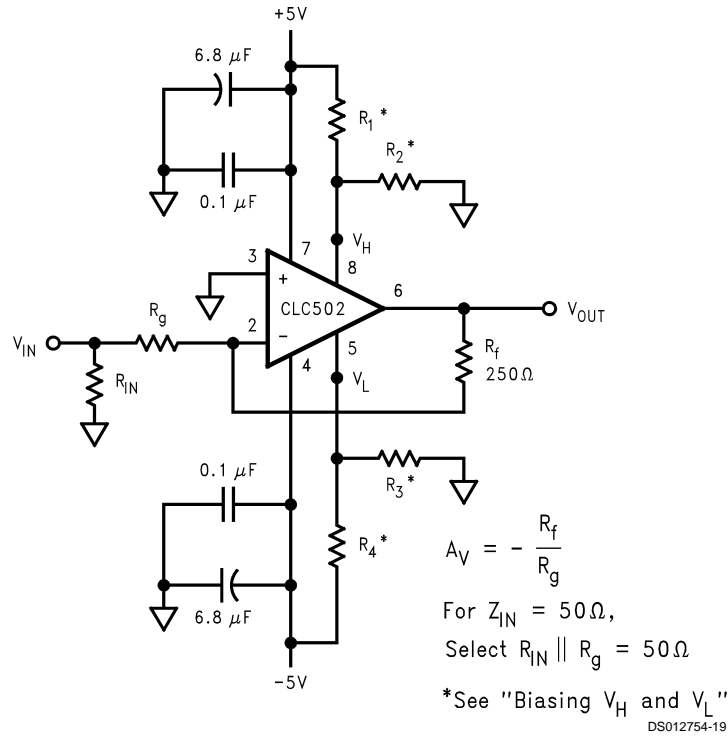
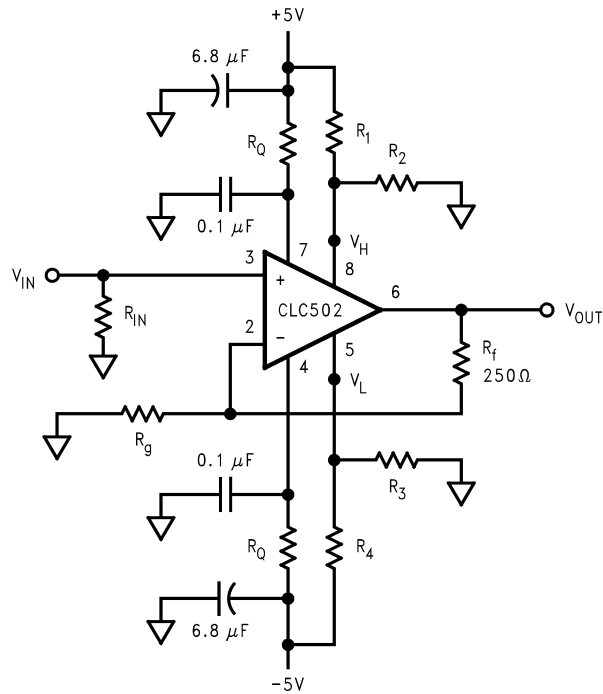

FIGURE 2. Recommended Inverting Gain Circuit



DS012754-20

FIGURE 3. Location of Damping Resistors ( $R_Q$ )



## Application Division (Continued)

### Clamp Operation

The maximum positive or negative excursion of the output voltage is determined by voltages applied to the clamping pins,  $V_H$  and  $V_L$ .  $V_H$  determines the positive clamping level;  $V_L$  determines the negative level. For example, if  $V_H$  is set at +2V and  $V_L$  is set at -0.5V the output voltage is restricted within this -0.5V to +2V range. When the output voltage tries to exceed this level, the amplifier goes into “clamp mode” and the output voltage limits at the clamp voltage.

### Clamp Accuracy and Amplifier Linearity

Ideally, the clamped output voltage and the clamp voltage should be identical. In practice, however, there are two sources of clamp inaccuracy: the inherent clamp accuracy (which is shown in the specification page) and resistor divider action of open-loop output resistance of  $10\Omega$  and the load resistor. Or, in equation form,

$$V_{OUT, \text{ clamp}} = (V_H \text{ or } V_L \pm 300 \text{ mV}) \frac{R_L}{R_L + 10\Omega}. \quad (1)$$

When settling the clamp voltages, the designer should also recognize that within about 200mV of the clamp voltages, amplifier linearity begins to deteriorate. (See plot on previous page.)

### Biasing $V_H$ and $V_L$

Each of the clamping pins is buffered internally so simple resistive voltage divider circuits work well in providing the clamp voltages.  $V_L$  and  $V_H$  can be set by choosing the divider resistors using:

$$V_H = (5V) \left( \frac{R_2}{R_1 + R_2} \right) \quad V_L = (-5V) \left( \frac{R_3}{R_3 + R_4} \right) \quad (2)$$

As a general guideline, let  $R_1 + R_2 \cong R_3 + R_4 \cong 5k\Omega$ .

$V_H$  should be biased more positively than  $V_L$ .  $V_H$  may be biased below 0V; however, with this biasing, the output voltage will actually clamp at 0V unless a simple pull down circuit is added to the op amp output (when clamped against  $V_H$ , the output cannot sink current). An analogous situation and design solution exists for  $V_L$  when it is biased above 0V, but in this case, a pull up circuit is used to source current when the amplifier is clamped against  $V_L$ .

The clamp voltage range rating is that for normal operation. Problems in over driven linearity may occur if the clamps are set outside this range so this is not suggested under any conditions. If the clamping capability is not required, the CLC402 (low gain op amp with fast 14-bit settling) may be a more appropriate part.

The clamps, which have a bandwidth of about 50MHz, may be driven by high frequency signal source. This allows the clamping level to be modulated, which is useful in many applications such as pulse amplitude modulation. The source resistance of the signal source should be less than  $500\Omega$  to ensure stability.

### Clamp-Mode Dynamics

As can be seen in the clamped pulse response plot, clamping is virtually instantaneous. Note, however, that there can be a small amount of overshoot, as indicated on the specification page. The output voltage stays at the clamp voltage level as long as the product of the input voltage and the gain setting exceeds the clamp voltage. When the input voltage decreases, it will eventually reach a point where it is no

longer trying to drive the output voltage above the clamp voltage. When this occurs, there is typically a 5-10ns “over-load recovery from clamp,” which is the time it takes for the op amp to resume linear operation. The normal op amp parameters, such as the rise time, apply when the op amp is in linear operation.

### Optimizing Settling Time Performance

To obtain the best possible settling time performance for the CLC502, some additional design criteria must be considered, particularly when driving loads of less than  $500\Omega$ . When driving a  $100\Omega$  load, a step of a few volts on the output will create a large step of current in the power supplies. In some cases, this step will cause a small ringing on the power supply due to the bypass capacitor ( $.1\mu\text{F}$ ) oscillating with the inductance in the power supply trace. The critical trace is the power supply trace between the two capacitors (a trace inductance of 20nH will be enough to degrade settling time performance). The frequency of the ring can be determined by

$$f = \frac{1}{2\pi \sqrt{C^* L_{\text{Trace}}}} \quad (3)$$

and any reduction in this frequency will improve performance due to better power supply rejection at lower frequencies. To obtain the best performance, small resistor,  $R_Q$ , may be added in the trace to dampen the circuit (See Figure 3). An  $R_Q$  of 5-10 $\Omega$  will result in excellent settling performance and will have only minor impact on other performance characteristics. No provision for  $R_Q$  has been made on the evaluation board available from National as part #730013. It can, however, be easily added by cutting a trace and adding a 5- 10 $\Omega$  resistor, as shown in Figure 3, for both supplies.

### DC Accuracy and Notes

Since the two inputs for the CLC502 are quite dissimilar, the noise and offset error performance differs somewhat from that of a standard differential input amplifier. The two input bias currents are physically unrelated rendering bias current cancellation through matching of the inverting and non-inverting source resistance ineffective.

In Equation 3, the output offset is the algebraic sum of the equivalent input voltage and current sources that influence DC operation. Output noise is determine similarly except that a root-sum-of-squares replaces the algebraic sum.  $R_s$  is the non-inverting pin source resistance.

$$\text{Output Offset } V_o = \pm \text{IBN} \times R_s (1 + R_f/R_g) \pm \text{VIO} (1 + R_f/R_g) \pm \text{IBI} \times R_f$$

### Printed Circuit Layout

As with any high frequency device, a good PCB layout will enhance performance. Ground plane construction and good power supply bypassing close to the package are critical to achieving full performance. In the non-inverting configuration, the amplifier is sensitive to stray capacitance to ground at the inverting input. Hence, the inverting node connections should be small with minimal coupling to the ground plane. Shunt capacitance across the feedback resistor should not be used to compensate for this effect.

The device is also very sensitive to parasitic capacitance on the output pin. The plots include a suggested series  $R_S$  to de-couple this effect. Evaluation boards (part number 730013 for through-hole and 730027 for SOIC) for the CLC502 are available.

**Physical Dimensions** inches (millimeters) unless otherwise noted

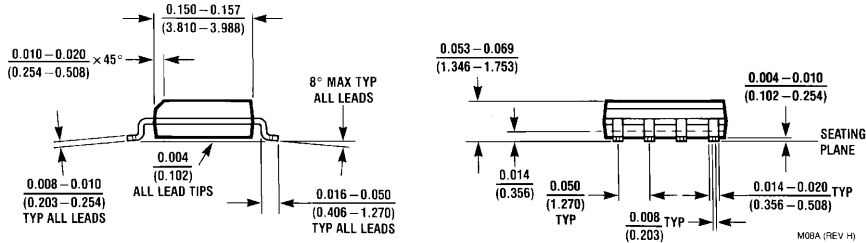
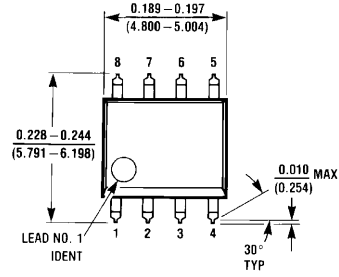

**8-Pin SOIC**  
**NS Package Number M08A**

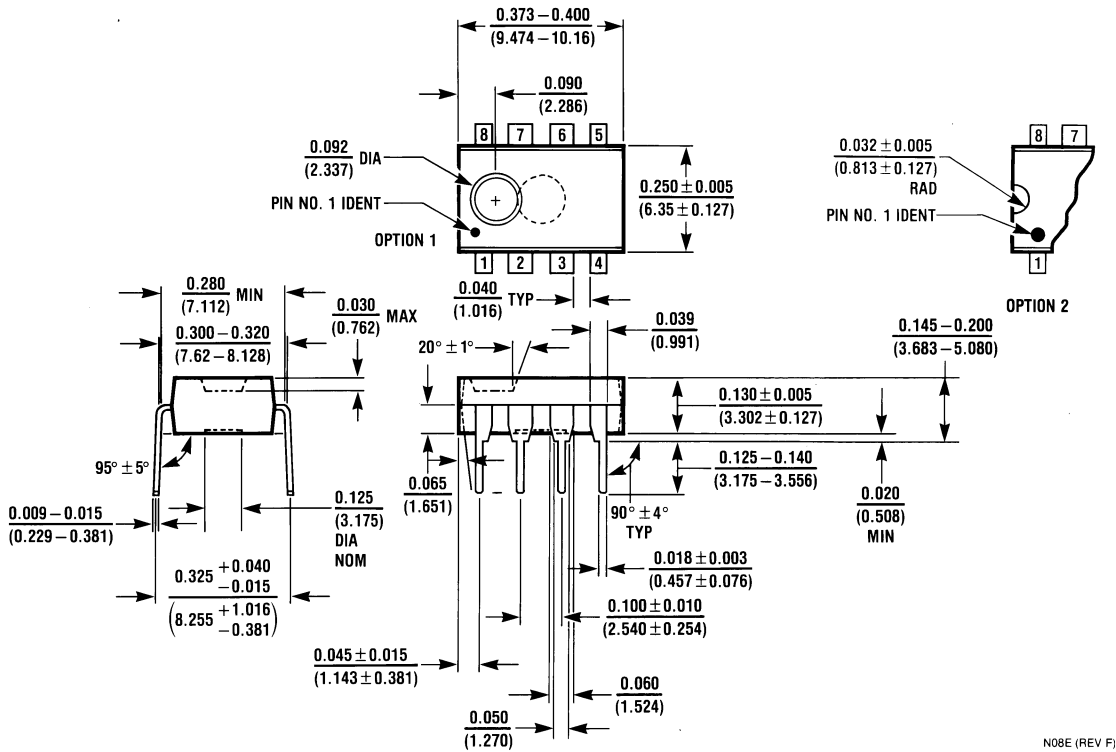

**8-Pin MDIP**  
**NS Package Number N08E**

## Notes

### LIFE SUPPORT POLICY

NATIONAL'S PRODUCTS ARE NOT AUTHORIZED FOR USE AS CRITICAL COMPONENTS IN LIFE SUPPORT DEVICES OR SYSTEMS WITHOUT THE EXPRESS WRITTEN APPROVAL OF THE PRESIDENT AND GENERAL COUNSEL OF NATIONAL SEMICONDUCTOR CORPORATION. As used herein:

1. Life support devices or systems are devices or systems which, (a) are intended for surgical implant into the body, or (b) support or sustain life, and whose failure to perform when properly used in accordance with instructions for use provided in the labeling, can be reasonably expected to result in a significant injury to the user.
2. A critical component is any component of a life support device or system whose failure to perform can be reasonably expected to cause the failure of the life support device or system, or to affect its safety or effectiveness.



**National Semiconductor Corporation**  
Americas  
Tel: 1-800-272-9959  
Fax: 1-800-737-7018  
Email: support@nsc.com  
www.national.com

**National Semiconductor Europe**  
Fax: +49 (0) 180-530 85 86  
Email: europe.support@nsc.com  
Deutsch Tel: +49 (0) 69 9508 6208  
English Tel: +44 (0) 870 24 0 2171  
Français Tel: +33 (0) 1 41 91 8790

**National Semiconductor Asia Pacific Customer Response Group**  
Tel: 65-2544466  
Fax: 65-2504466  
Email: ap.support@nsc.com

**National Semiconductor Japan Ltd.**  
Tel: 81-3-5639-7560  
Fax: 81-3-5639-7507

## IMPORTANT NOTICE

Texas Instruments Incorporated and its subsidiaries (TI) reserve the right to make corrections, modifications, enhancements, improvements, and other changes to its products and services at any time and to discontinue any product or service without notice. Customers should obtain the latest relevant information before placing orders and should verify that such information is current and complete. All products are sold subject to TI's terms and conditions of sale supplied at the time of order acknowledgment.

TI warrants performance of its hardware products to the specifications applicable at the time of sale in accordance with TI's standard warranty. Testing and other quality control techniques are used to the extent TI deems necessary to support this warranty. Except where mandated by government requirements, testing of all parameters of each product is not necessarily performed.

TI assumes no liability for applications assistance or customer product design. Customers are responsible for their products and applications using TI components. To minimize the risks associated with customer products and applications, customers should provide adequate design and operating safeguards.

TI does not warrant or represent that any license, either express or implied, is granted under any TI patent right, copyright, mask work right, or other TI intellectual property right relating to any combination, machine, or process in which TI products or services are used. Information published by TI regarding third-party products or services does not constitute a license from TI to use such products or services or a warranty or endorsement thereof. Use of such information may require a license from a third party under the patents or other intellectual property of the third party, or a license from TI under the patents or other intellectual property of TI.

Reproduction of TI information in TI data books or data sheets is permissible only if reproduction is without alteration and is accompanied by all associated warranties, conditions, limitations, and notices. Reproduction of this information with alteration is an unfair and deceptive business practice. TI is not responsible or liable for such altered documentation. Information of third parties may be subject to additional restrictions.

Resale of TI products or services with statements different from or beyond the parameters stated by TI for that product or service voids all express and any implied warranties for the associated TI product or service and is an unfair and deceptive business practice. TI is not responsible or liable for any such statements.

TI products are not authorized for use in safety-critical applications (such as life support) where a failure of the TI product would reasonably be expected to cause severe personal injury or death, unless officers of the parties have executed an agreement specifically governing such use. Buyers represent that they have all necessary expertise in the safety and regulatory ramifications of their applications, and acknowledge and agree that they are solely responsible for all legal, regulatory and safety-related requirements concerning their products and any use of TI products in such safety-critical applications, notwithstanding any applications-related information or support that may be provided by TI. Further, Buyers must fully indemnify TI and its representatives against any damages arising out of the use of TI products in such safety-critical applications.

TI products are neither designed nor intended for use in military/aerospace applications or environments unless the TI products are specifically designated by TI as military-grade or "enhanced plastic." Only products designated by TI as military-grade meet military specifications. Buyers acknowledge and agree that any such use of TI products which TI has not designated as military-grade is solely at the Buyer's risk, and that they are solely responsible for compliance with all legal and regulatory requirements in connection with such use.

TI products are neither designed nor intended for use in automotive applications or environments unless the specific TI products are designated by TI as compliant with ISO/TS 16949 requirements. Buyers acknowledge and agree that, if they use any non-designated products in automotive applications, TI will not be responsible for any failure to meet such requirements.

Following are URLs where you can obtain information on other Texas Instruments products and application solutions:

### Products

|                        |  |
|------------------------|--|
| Audio                  | <a href="http://www.ti.com/audio">www.ti.com/audio</a>                               |
| Amplifiers             | <a href="http://amplifier.ti.com">amplifier.ti.com</a>                               |
| Data Converters        | <a href="http://dataconverter.ti.com">dataconverter.ti.com</a>                       |
| DLP® Products          | <a href="http://www.dlp.com">www.dlp.com</a>   |
| DSP                    | <a href="http://dsp.ti.com">dsp.ti.com</a>   |
| Clocks and Timers      | <a href="http://www.ti.com/clocks">www.ti.com/clocks</a>                             |
| Interface              | <a href="http://interface.ti.com">interface.ti.com</a>                               |
| Logic                  | <a href="http://logic.ti.com">logic.ti.com</a>                                       |
| Power Mgmt             | <a href="http://power.ti.com">power.ti.com</a>                                       |
| Microcontrollers       | <a href="http://microcontroller.ti.com">microcontroller.ti.com</a>                   |
| RFID                   | <a href="http://www.ti-rfid.com">www.ti-rfid.com</a>                                 |
| OMAP Mobile Processors | <a href="http://www.ti.com/omap">www.ti.com/omap</a>                                 |
| Wireless Connectivity  | <a href="http://www.ti.com/wirelessconnectivity">www.ti.com/wirelessconnectivity</a> |

### Applications

|                               |  |
|-------------------------------|--|
| Communications and Telecom    | <a href="http://www.ti.com/communications">www.ti.com/communications</a>                 |
| Computers and Peripherals     | <a href="http://www.ti.com/computers">www.ti.com/computers</a>                           |
| Consumer Electronics          | <a href="http://www.ti.com/consumer-apps">www.ti.com/consumer-apps</a>                   |
| Energy and Lighting           | <a href="http://www.ti.com/energy">www.ti.com/energy</a>                                 |
| Industrial                    | <a href="http://www.ti.com/industrial">www.ti.com/industrial</a>                         |
| Medical                       | <a href="http://www.ti.com/medical">www.ti.com/medical</a>                               |
| Security                      | <a href="http://www.ti.com/security">www.ti.com/security</a>                             |
| Space, Avionics and Defense   | <a href="http://www.ti.com/space-avionics-defense">www.ti.com/space-avionics-defense</a> |
| Transportation and Automotive | <a href="http://www.ti.com/automotive">www.ti.com/automotive</a>                         |
| Video and Imaging             | <a href="http://www.ti.com/video">www.ti.com/video</a>                                   |

TI E2E Community Home Page

[e2e.ti.com](http://e2e.ti.com)

Mailing Address: Texas Instruments, Post Office Box 655303, Dallas, Texas 75265  
Copyright © 2011, Texas Instruments Incorporated