

## CLC401 Fast Settling, Wideband High Gain Monolithic Op Amp

Check for Samples: [CLC401](#)

### FEATURES

- **-3dB bandwidth of 150MHz**
- **0.1% settling in 10ns**
- **Low power, 150mW**
- **Overload and short circuit protected**
- **Stable without compensation**
- **Recommended gain range,  $\pm 7$  to  $\pm 50$**

### APPLICATIONS

- **Flash, precision A/D conversion**
- **Photodiode, CCD preamps**
- **IF processors**
- **High speed modems, radios**
- **Line drivers**
- **DC coupled log amplifiers**
- **High speed communications**

Figure 1. Pulse Response

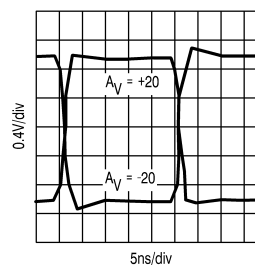

### DESCRIPTION

The CLC401 is a wideband, fast settling op amp designed for applications requiring gains greater than  $\pm 7$ . Constructed using an advanced complementary bipolar process and a proprietary design, the CLC401 features dynamic performance far beyond that of typical high speed monolithic op amps. For example, at a gain of +20, the -3dB bandwidth is 150MHz and the rise/fall time is only 2.5ns.

The wide bandwidth and linear phase ( $0.2^\circ$  deviation from linear at 50MHz) and a very flat gain response makes the CLC401 ideal for many digital communication system applications. For example, demodulators need both DC coupling and high frequency amplification-requirements that are ordinarily difficult to meet.

The very fast 10ns settling to 0.1% and the ability to drive capacitive loads lend themselves well to flash A/D applications. Systems employing D/A converters also benefit from the settling time and also by the fact that current-to-voltage transimpedance amplification is easily accomplished.

The CLC401 provides a quick, effective design solution. Its stable operation over the entire  $\pm 7$  to  $\pm 50$  gain range precludes the need for external compensation. And, unlike many other high speed-op amps, the CLC401's power dissipation of 150mW is compatible with designs which must limit total power dissipation or power supply requirements.

The CLC401 is based on **National's** proprietary op amp topology that uses current feedback instead of the usual voltage feedback. This unique design has many advantages over conventional designs (such as settling time that is relatively independent of gain), yet it is used in basically the same way (see the gain equations in [Figure 4](#) and [Figure 5](#)). However, an understanding of the topology will aid in achieving the best performance. The discussion below will proceed for the non-inverting gain configuration with the inverting mode analysis being very similar.

### Enhanced Solutions (Military/Aerospace)

SMD Number: 5962-89973

Space level versions also available.



Please be aware that an important notice concerning availability, standard warranty, and use in critical applications of Texas Instruments semiconductor products and disclaimers thereto appears at the end of this data sheet.

All trademarks are the property of their respective owners.

For more information, visit <http://www.national.com/mil>

## Connection Diagram

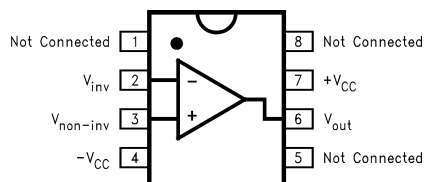

**Figure 2. Pinout  
DIP & SOIC**

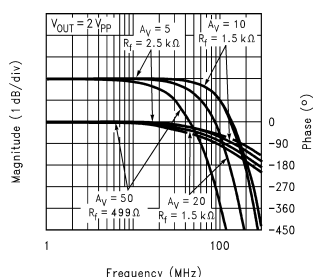

**Figure 3. Non-Inverting Frequency Response**



These devices have limited built-in ESD protection. The leads should be shorted together or the device placed in conductive foam during storage or handling to prevent electrostatic damage to the MOS gates.

## Absolute Maximum Ratings <sup>(1)</sup>

Supply Voltage ( $V_{CC}$ )	$\pm 7V$
$I_{OUT}$ Output is short circuit protected to ground, but maximum reliability will be maintained if $I_{OUT}$ does not exceed...	60mA
Common Mode Input Voltage	$\pm V_{CC}$
Differential Input Voltage	5V
Junction Temperature Range	+150°C
Operating Temperature Range	-40°C to +85°C
Storage Temperature Range	-65°C to +150°C
Lead Solder Duration (+300°C)	10 sec

(1) "Absolute Maximum Ratings" are those values beyond which the safety of the device cannot be guaranteed. They are not meant to imply that the devices should be operated at these limits. The table of "Electrical Characteristics" specifies conditions of device operation.

## Operating Ratings

Thermal Resistance		
Package	( $\theta_{JC}$ )	( $\theta_{JA}$ )
MDIP	70°C/W	125°C/W
SOIC	65°C/W	145°C/W

## Electrical Characteristics

( $A_v = +20$ ,  $V_{CC} = \pm 5V$ ,  $R_L = 100\Omega$ ,  $R_f = 1.5k\Omega$ ; unless specified).

Symbol	Parameter	Conditions	Typ	Max/Min Ratings (1)			Units
Ambient Temperature		CLC401AJ	+25°C	-40°C	+25°C	+85°C	
<b>Frequency Domain Response</b>							
SSBW	-3dB Bandwidth	$V_{OUT} < 2V_{PP}$	150	>100	>100	>70	MHz
LSBW		$V_{OUT} < 5V_{PP}$	100	>65	>65	>55	MHz
	Gain Flatness	$V_{OUT} < 2V_{PP}$					
GFPL	Peaking	<25MHz	0	<0.1	<0.1	<0.1	dB
GFPH	Peaking	>25MHz	0	<0.2	<0.2	<0.2	dB
GFR	Rolloff	<50MHz	0.2	<1.0	<1.0	<1.3	dB
LPD	Linear Phase Deviation	DC to 50MHz	0.2	<1.0	<1.0	<1.5	deg
<b>Time Domain Response</b>							
TRS	Rise and Fall Time	2V Step	2.5	<3.5	<3.5	<5.0	ns
TRL		5V Step	5	<7.0	<7.0	<8.0	ns
TS	Settling Time to $\pm 0.1\%$	2V Step	10	<15	<15	<15	ns
OS	Overshoot	2V Step	0	<10	<10	<10	%
SR	Slew Rate		1200	>800	>800	>700	V/ $\mu$ s
<b>Distortion And Noise Response</b>							
HD2	2nd Harmonic Distortion	$2V_{PP}$ , 20MHz	-45	<-35	<-35	<-35	dBc
HD3	3rd Harmonic Distortion	$2V_{PP}$ , 20MHz	-60	<-50	<-50	<-45	dBc
	Equivalent Input Noise						
SNF	Noise Floor	>1MHz	-158	<-155	<-155	<-154	dBm (1Hz)
INV	Integrated Noise	1MHz to 150MHz	35	<50	<50	<55	$\mu$ V
<b>Static, DC Performance</b>							
VIO	Input Offset Voltage (2)		3	$\pm 10.0$	$\pm 6.0$	$\pm 11.0$	mV
DVIO	Average Temperature Coefficient		20	$\pm 50$	-	$\pm 50$	$\mu$ V/°C
IBN	Input Bias Current (2)	Non-Inverting	10	$\pm 36$	$\pm 20$	$\pm 20$	$\mu$ A
DIBN	Average Temperature Coefficient		100	$\pm 200$	-	$\pm 100$	nA/°C
IBI	Input Bias Current (2)	Inverting	10	46	30	40	$\mu$ A
DIBI	Average Temperature Coefficient		100	$\pm 200$	-	$\pm 100$	nA/°C
PSRR	Power Supply Rejection Ratio		55	50	50	50	dB
CMRR	Common Mode Rejection Ratio		55	50	50	50	dB
ICC	Supply Current (2)	No Load	15	21	21	21	mA
<b>Miscellaneous Performance</b>							
RIN	Non-Inverting Input	Resistance	200	>50	>100	>100	k $\Omega$
CIN		Capacitance	0.5	<2.5	<2.5	<2.5	pF
RO	Output Impedance	at DC	0.2	<0.3	<0.3	<0.3	$\Omega$
VO	Output Voltage Range	No Load	3.5	>3.0	>3.2	>3.2	V
CMIR	Common Mode Input Range	For Rated Performance	2.8	>2.0	>2.5	>2.5	V
IO	Output Current		60	>35	>50	>50	mA

(1) Max/min ratings are based on product characterization and simulation. Individual parameters are tested as noted. Outgoing quality levels are determined from tested parameters.

(2) AJ-level: spec. is 100% tested at +25°C.

### Typical Performance Characteristics

( $T_A = 25^\circ$ ,  $A_V = +20$ ,  $V_{CC} = \pm 5V$ ,  $R_L = 100\Omega$ : Unless Specified).

#### Non-Inverting Frequency Response

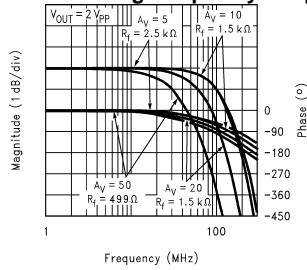

#### Inverting Frequency Response

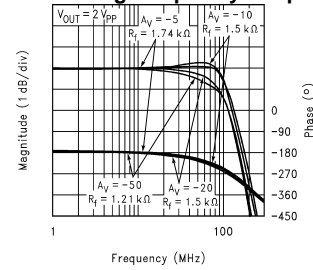

#### Frequency Response for Various $R_L$ s

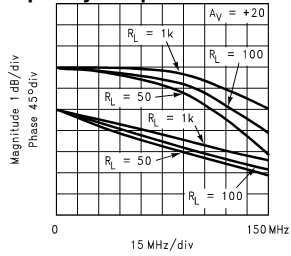

#### Open-Loop Transimpedance Gain, Z(s)

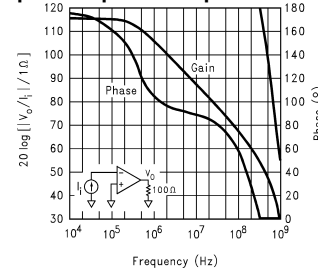

#### 2nd and 3rd Harmonic Distortion

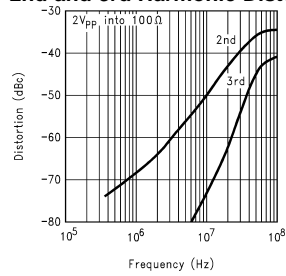

#### 2-Tone, 3rd Order, Intermodulation Intercept

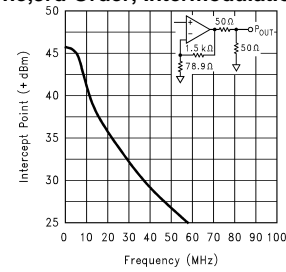

#### Equivalent Input Noise

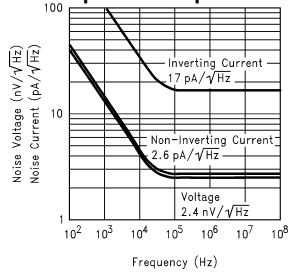

#### CMRR and PSRR

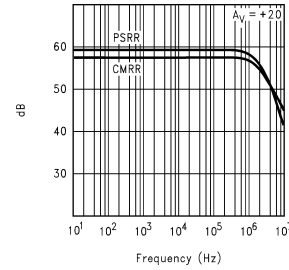

#### Pulse Response

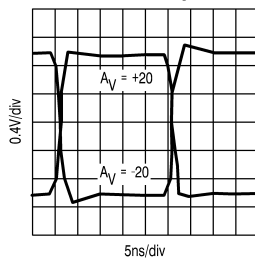

#### Settling Time

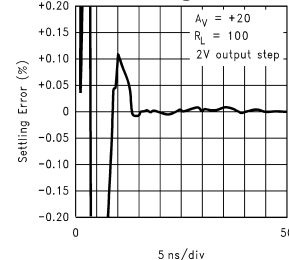

Typical Performance Characteristics (continued)

( $T_A = 25^\circ$ ,  $A_V = +20$ ,  $V_{CC} = \pm 5V$ ,  $R_L = 100\Omega$ : Unless Specified).

Long-Term Settling Time

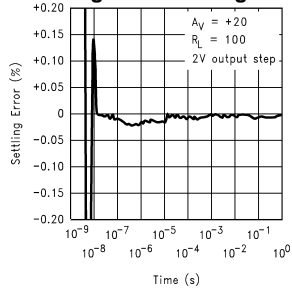

Settling Time vs. Load Capacitance

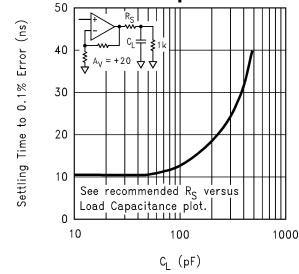

Recommended  $R_S$  vs. Load Capacitance

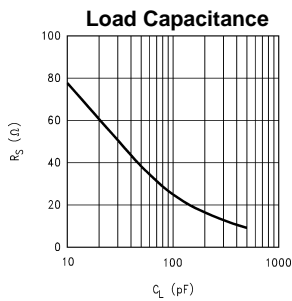

Low Gain & Transimpedance Applications

The CLC401 may be used at gains down to unity ( $A_V = \pm 1$ ) by choosing  $R_f$  according to Equation (4) in this datasheet. The curves to the right show performance at inverting unity gain with  $R_f = 2500\Omega$ , a configuration appropriate for D/A converter buffering and other transimpedance applications.

Frequency Response,  $A_V = -1$ ,  $R_f = 2.25k\Omega$

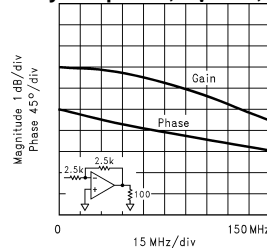

Application Division

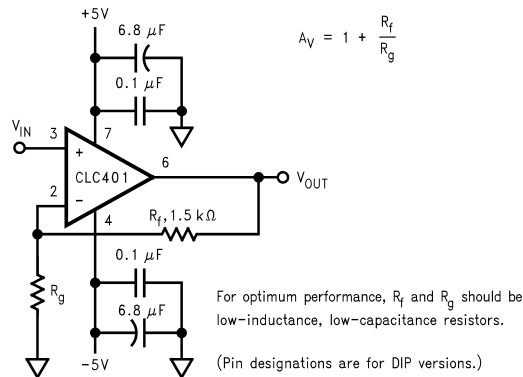
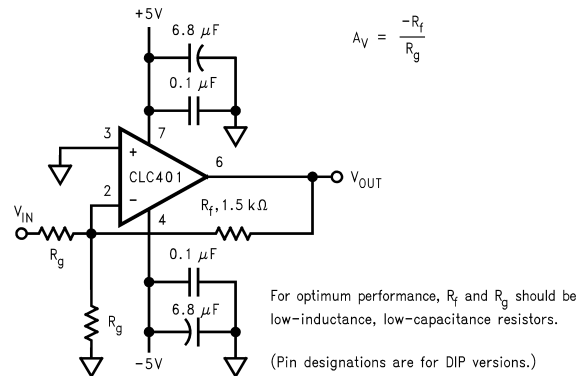

Figure 4. Recommended Non-Inverting Gain Circuit



**Figure 5. Recommended Inverting Gain Circuit**

### Understanding the Loop Gain

Referring to the equivalent circuit of [Figure 6](#), any current flowing in the inverting input is amplified to a voltage at the output through the transimpedance gain shown on the plots on page 3. This  $Z(s)$  is analogous to the open-loop gain of a voltage feedback amplifier.

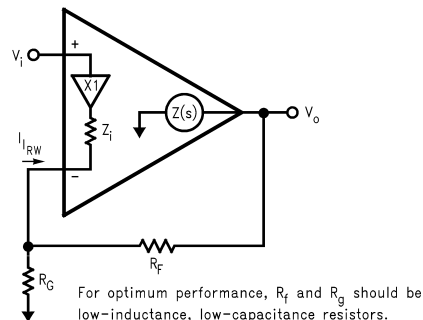

**Figure 6. Current feedback topology**

Developing the non-inverting frequency response for the topology of [Figure 6](#) yields:

#### Equation 1

$$\frac{V_O}{V_i} = \frac{1 + R_f / R_g}{1 - 1 / LG} \quad (1)$$

where LG is the loop gain defined by,

#### Equation 2

$$LG = \frac{Z(s)}{R_f} \times \frac{1}{1 + Z_i / (R_f \parallel R_g)} \quad (2)$$

Equation 1 has a form identical to that for a voltage feedback amplifier with the differences occurring in the LG expression. For an idealized treatment, set  $Z_i = 0$  which results in a very simple  $LG = Z(s)/R_f$  (Derivation of the transfer function for the case where  $Z_i = 0$  is given in Application Note AN300-1). Using the  $Z(s)$  (open-loop transimpedance gain) plot shown on the previous page and dividing by the recommended  $R_f = 1.5\text{k}\Omega$ , yields a large loop gain at DC. As a result, Equation 1 shows that the closed-loop gain at DC is very close to  $(1 + R_f/R_g)$ .

At higher frequencies, the roll-off of  $Z(s)$  determines the closed-loop frequency response which, ideally, is dependent only on  $R_f$ . **The specifications reported on the previous pages are therefore valid only for the specified  $R = 1.5\text{k}\Omega$ .** Increasing  $R$  from  $1.5\text{k}\Omega$  will decrease the loop gain and band width, while decreasing it will increase the loop gain possibly leading to inadequate phase margin and closed-loop peaking. Conversely, fixing  $R_f$  will hold the frequency response constant while the closed-loop gain can be adjusted using  $R_g$ .

The CLC401 departs from this idealized analysis to the extent that the inverting input impedance is finite. With the low quiescent power of the CLC401,  $Z_i \cong 50\Omega$  leading to drop in loop gain and bandwidth at high gain settlings, as given by Equation 2. The second term in Equation 2 accounts for the division in feedback current that occurs between  $Z_i$  and  $R_f \parallel R_g$  at the inverting node of the CLC400. This decrease in bandwidth can be circumvented as described in “Increasing Bandwidth at High Gains.”

### DC Accuracy and Noise

Since the two inputs for the CLC401 are quite dissimilar, the noise and offset error performance differs somewhat from that of a standard differential input amplifier. Specifically, the inverting input current noise is much larger than the non-inverting current noise. Also the two input bias currents are physically unrelated rendering bias current cancellation through matching of the inverting and non-inverting pin resistors ineffective.

In Equation 3, the output offset is the algebraic sum of the equivalent input voltage and current sources that influence DC operation. Output noise is determined similarly except that a root-sum-of-squares replaces the algebraic sum.  $R_s$  is the non-inverting pin resistance.

#### Equation 3

$$\text{Output Offset } V_O = \pm I_{BN} \times R_S (1 + R_f/R_g) \pm V_{IO} (1 + R_f/R_g) \pm I_{BI} \times R_f \quad (3)$$

An important observation is that for fixed  $R_f$ , offsets as referred to the input improve as the gain is increased (divide all terms by  $1 + R_f/R_g$ ). A similar result is obtained for noise where noise figure improves as gain increases.

### Selecting Between the CLC400 or CLC401

The CLC400 is intended for gains of  $\pm 1$  to  $\pm 8$  while the CLC401 is designed for gains of  $\pm 7$  to  $\pm 50$ . Optimum performance is achieved with a feedback resistor of  $250\Omega$  with the CLC400 and  $1.5\Omega$  with the CLC401- this distinction may be important in transimpedance applications such as D/A buffering. Although the CLC400 can be used at higher gains, the CLC401 will provide a wider bandwidth because loop gain losses due to finite  $Z_i$  are lower with the larger CLC401 feedback resistor as explained above. On the other hand, the lower recommended feedback resistance of the CLC400 minimizes the output errors due to inverting input noise and bias currents.

### Increasing Bandwidth At High Gains

Bandwidth may be increased at high closed-loop gains by adjusting  $R_f$  and  $R_g$  to make up for the losses in loop gain that occur at these high gain settlings due to current division at the inverting input. An approximate relationship may be obtained by holding the LG expression constant as the gain is changed from the design point used in the specifications (that is,  $R_f = 1.5k\Omega$  and  $R_g = 79\Omega$ ). For the CLC401 this gives,

#### Equation 4

$$R_f = 2500 - 50A_V \text{ and } R_g = \frac{2500 - 50A_V}{A_V - 1} \quad (4)$$

where  $A_V$  is the desired non-inverting gain. Note that with  $A_V = +20$  we get the specified  $R_f = 1.5k\Omega$ , while at higher gains, a lower value gives stable performance with improved bandwidth.

### Capacitive Feedback

Capacitive feedback should not be used with the CLC401 because of the potential for loop instability. See Application Note OA-7 for active filter realizations with the CLC401.

### Printed Circuit Layout

As with any high frequency device, a good PCB layout will enhance performance. Ground plane construction and good power supply bypassing close to the package are critical to achieving full performance. In the non-inverting configuration, the amplifier is sensitive to stray capacitance to ground at the inverting input. Hence, the inverting node connections should be small with minimal coupling to the ground plane. Shunt capacitance across the feedback resistor should not be used to compensate for this effect.

Parasitic or load capacitance directly on the output will introduce additional phase shift in the loop degrading the loop phase margin and leading to frequency response peaking. A small series resistor before the capacitance effectively decouples this effect. The graphs on the preceding page illustrate the required resistor value and resulting performance vs. capacitance.

Precision buffed resistors (PRP8351 series from Precision Resistive Products) with low parasitic reactances were used to develop the data sheet specifications. Precision carbon composition resistors will also yield excellent results. Standard spirally-trimmed RN55D metal film resistors will work with the slight decrease in bandwidth due to their reactive nature at high frequencies.

Evaluation PC boards (part no. CLC730013 for through-hole and CLC730027 for SOIC) for the CLC401 are available.



## IMPORTANT NOTICE

Texas Instruments Incorporated and its subsidiaries (TI) reserve the right to make corrections, enhancements, improvements and other changes to its semiconductor products and services per JESD46, latest issue, and to discontinue any product or service per JESD48, latest issue. Buyers should obtain the latest relevant information before placing orders and should verify that such information is current and complete. All semiconductor products (also referred to herein as "components") are sold subject to TI's terms and conditions of sale supplied at the time of order acknowledgment.

TI warrants performance of its components to the specifications applicable at the time of sale, in accordance with the warranty in TI's terms and conditions of sale of semiconductor products. Testing and other quality control techniques are used to the extent TI deems necessary to support this warranty. Except where mandated by applicable law, testing of all parameters of each component is not necessarily performed.

TI assumes no liability for applications assistance or the design of Buyers' products. Buyers are responsible for their products and applications using TI components. To minimize the risks associated with Buyers' products and applications, Buyers should provide adequate design and operating safeguards.

TI does not warrant or represent that any license, either express or implied, is granted under any patent right, copyright, mask work right, or other intellectual property right relating to any combination, machine, or process in which TI components or services are used. Information published by TI regarding third-party products or services does not constitute a license to use such products or services or a warranty or endorsement thereof. Use of such information may require a license from a third party under the patents or other intellectual property of the third party, or a license from TI under the patents or other intellectual property of TI.

Reproduction of significant portions of TI information in TI data books or data sheets is permissible only if reproduction is without alteration and is accompanied by all associated warranties, conditions, limitations, and notices. TI is not responsible or liable for such altered documentation. Information of third parties may be subject to additional restrictions.

Resale of TI components or services with statements different from or beyond the parameters stated by TI for that component or service voids all express and any implied warranties for the associated TI component or service and is an unfair and deceptive business practice. TI is not responsible or liable for any such statements.

Buyer acknowledges and agrees that it is solely responsible for compliance with all legal, regulatory and safety-related requirements concerning its products, and any use of TI components in its applications, notwithstanding any applications-related information or support that may be provided by TI. Buyer represents and agrees that it has all the necessary expertise to create and implement safeguards which anticipate dangerous consequences of failures, monitor failures and their consequences, lessen the likelihood of failures that might cause harm and take appropriate remedial actions. Buyer will fully indemnify TI and its representatives against any damages arising out of the use of any TI components in safety-critical applications.

In some cases, TI components may be promoted specifically to facilitate safety-related applications. With such components, TI's goal is to help enable customers to design and create their own end-product solutions that meet applicable functional safety standards and requirements. Nonetheless, such components are subject to these terms.

No TI components are authorized for use in FDA Class III (or similar life-critical medical equipment) unless authorized officers of the parties have executed a special agreement specifically governing such use.

Only those TI components which TI has specifically designated as military grade or "enhanced plastic" are designed and intended for use in military/aerospace applications or environments. Buyer acknowledges and agrees that any military or aerospace use of TI components which have **not** been so designated is solely at the Buyer's risk, and that Buyer is solely responsible for compliance with all legal and regulatory requirements in connection with such use.

TI has specifically designated certain components which meet ISO/TS16949 requirements, mainly for automotive use. Components which have not been so designated are neither designed nor intended for automotive use; and TI will not be responsible for any failure of such components to meet such requirements.

### Products

Audio	<a href="http://www.ti.com/audio">www.ti.com/audio</a>
Amplifiers	<a href="http://amplifier.ti.com">amplifier.ti.com</a>
Data Converters	<a href="http://dataconverter.ti.com">dataconverter.ti.com</a>
DLP® Products	<a href="http://www.dlp.com">www.dlp.com</a>
DSP	<a href="http://dsp.ti.com">dsp.ti.com</a>
Clocks and Timers	<a href="http://www.ti.com/clocks">www.ti.com/clocks</a>
Interface	<a href="http://interface.ti.com">interface.ti.com</a>
Logic	<a href="http://logic.ti.com">logic.ti.com</a>
Power Mgmt	<a href="http://power.ti.com">power.ti.com</a>
Microcontrollers	<a href="http://microcontroller.ti.com">microcontroller.ti.com</a>
RFID	<a href="http://www.ti-rfid.com">www.ti-rfid.com</a>
OMAP Applications Processors	<a href="http://www.ti.com/omap">www.ti.com/omap</a>
Wireless Connectivity	<a href="http://www.ti.com/wirelessconnectivity">www.ti.com/wirelessconnectivity</a>

### Applications

Automotive and Transportation	<a href="http://www.ti.com/automotive">www.ti.com/automotive</a>
Communications and Telecom	<a href="http://www.ti.com/communications">www.ti.com/communications</a>
Computers and Peripherals	<a href="http://www.ti.com/computers">www.ti.com/computers</a>
Consumer Electronics	<a href="http://www.ti.com/consumer-apps">www.ti.com/consumer-apps</a>
Energy and Lighting	<a href="http://www.ti.com/energy">www.ti.com/energy</a>
Industrial	<a href="http://www.ti.com/industrial">www.ti.com/industrial</a>
Medical	<a href="http://www.ti.com/medical">www.ti.com/medical</a>
Security	<a href="http://www.ti.com/security">www.ti.com/security</a>
Space, Avionics and Defense	<a href="http://www.ti.com/space-avionics-defense">www.ti.com/space-avionics-defense</a>
Video and Imaging	<a href="http://www.ti.com/video">www.ti.com/video</a>

### TI E2E Community

[e2e.ti.com](http://e2e.ti.com)