

CD54/74AC540, CD54/74AC541 CD54/74ACT540, CD54/74ACT541

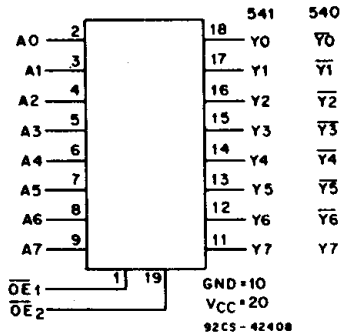

Data sheet acquired from Harris Semiconductor
SCHS285A – Revised November 1999



FUNCTIONAL DIAGRAM

Octal Buffer/Line Drivers, 3-State

CD74AC/ACT540 - Inverting
CD74AC/ACT541 - Non-Inverting

Type Features:

- Buffered inputs
- Typical propagation delay:
4.5 ns @ $V_{CC} = 5V$, $T_A = 25^\circ C$, $C_L = 50 pF$

The CD54/74AC540, -541, and CD54/74ACT540, -541 octal buffer/line drivers use the RCA ADVANCED CMOS technology. The CD54/74AC/ACT540 are inverting 3-state buffers having two active-LOW output enables. The CD54/74AC/ACT541 are non-inverting 3-state buffers having two active-LOW output enables.

The CD74AC540, -541, and CD74ACT540, -541 are supplied in 20-lead dual-in-line plastic packages (E suffix) and in 20-lead dual-in-line small-outline plastic packages (M suffix). Both package types are operable over the following temperature ranges: Industrial (-40 to +85°C) and Extended Industrial/Military (-55 to +125°C).

The CD54AC540, -541, and CD54ACT540, -541, available in chip form (H suffix), are operable over the -55 to +125°C temperature range.

Family Features:

- Exceeds 2-kV ESD Protection - MIL-STD-883, Method 3015
- SCR-Latchup-resistant CMOS process and circuit design
- Speed of bipolar FAST®/AS/S with significantly reduced power consumption
- Balanced propagation delays
- AC types feature 1.5-V to 5.5-V operation and balanced noise immunity at 30% of the supply.
- ± 24-mA output drive current
 - Fanout to 15 FAST® ICs
 - Drives 50-ohm transmission lines

®FAST is a Registered Trademark of Fairchild Semiconductor Corp.

TRUTH TABLE

CD54/74AC/ACT540		
INPUTS		OUTPUTS
OE1, OE2	A	Y
L	L	H
L	H	L
H	X	Z

TRUTH TABLE

CD54/74AC/ACT541		
INPUTS		OUTPUTS
OE1, OE2	A	Y
L	L	L
L	H	H
H	X	Z

H = High Voltage
L = Low Voltage
X = Immaterial
Z = High Impedance



CD54/74AC540, CD54/74AC541 CD54/74ACT540, CD54/74ACT541

MAXIMUM RATINGS, Absolute-Maximum Values:

DC SUPPLY-VOLTAGE (V_{CC})	-0.5 to 6 V
DC INPUT DIODE CURRENT, I_{IK} (for $V_I < -0.5$ or $V_I > V_{CC} + 0.5$ V)	± 20 mA
DC OUTPUT DIODE CURRENT, I_{OK} (for $V_O < -0.5$ or $V_O > V_{CC} + 0.5$ V)	± 50 mA
DC OUTPUT SOURCE OR SINK CURRENT per Output Pin, I_O (for $V_O > -0.5$ or $V_O < V_{CC} + 0.5$ V)	± 50 mA
DC V_{CC} OR GROUND CURRENT (I_{CC} or I_{GND})	± 100 mA*
PACKAGE THERMAL IMPEDANCE, θ_{JA} (see Note 1): E package	69°C/W
M package	58°C/W
STORAGE TEMPERATURE (T_{stg})	-65 to +150°C
LEAD TEMPERATURE (DURING SOLDERING):		
At distance $1/16 \pm 1/32$ in. (1.59 ± 0.79 mm) from case for 10 s maximum	+265°C
Unit inserted into PC board min. thickness $1/16$ in. (1.59 mm) with solder contacting lead tips only	+300°C

* For up to 4 outputs per device: add ± 25 mA for each additional output.

NOTE 1: The package thermal impedance is calculated in accordance with JESD 51.

RECOMMENDED OPERATING CONDITIONS:

For maximum reliability, normal operating conditions should be selected so that operation is always within the following ranges:

CHARACTERISTIC	LIMITS		UNITS
	MIN.	MAX.	
Supply-Voltage Range, V_{CC} *: (For T_A = Full Package-Temperature Range)			
AC Types	1.5	5.5	V
ACT Types	4.5	5.5	V
DC Input or Output Voltage, V_i, V_o	0	V_{CC}	V
Operating Temperature, T_A :	-55	+125	°C
Input Rise and Fall Slew Rate, dt/dv			
at 1.5 V to 3 V (AC Types)	0	50	ns/V
at 3.6 V to 5.5 V (AC Types)	0	20	ns/V
at 4.5 V to 5.5 V (ACT Types)	0	10	ns/V

*Unless otherwise specified, all voltages are referenced to ground.

TERMINAL ASSIGNMENT DIAGRAMS

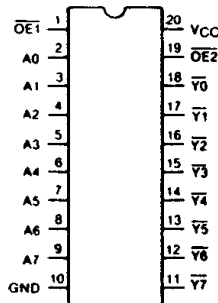

CD54/74AC/ACT540

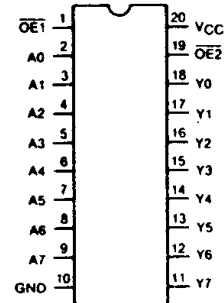

CD54/74AC/ACT541

Technical Data

CD54/74AC540, CD54/74AC541 CD54/74ACT540, CD54/74ACT541

STATIC ELECTRICAL CHARACTERISTICS: AC Series

CHARACTERISTICS	TEST CONDITIONS		V _{CC} (V)	AMBIENT TEMPERATURE (T _A) - °C						UNITS	
				+25		-40 to +85		-55 to +125			
				MIN.	MAX.	MIN.	MAX.	MIN.	MAX.		
High-Level Input Voltage V _{IH}			1.5	1.2	—	1.2	—	1.2	—	V	
			3	2.1	—	2.1	—	2.1	—		
			5.5	3.85	—	3.85	—	3.85	—		
Low-Level Input Voltage V _{IL}			1.5	—	0.3	—	0.3	—	0.3	V	
			3	—	0.9	—	0.9	—	0.9		
			5.5	—	1.65	—	1.65	—	1.65		
High-Level Output Voltage V _{OH}	V _{IH} or V _{IL}	#, *	-0.05	1.5	1.4	—	1.4	—	1.4	—	V
			-0.05	3	2.9	—	2.9	—	2.9	—	
			-0.05	4.5	4.4	—	4.4	—	4.4	—	
			-4	3	2.58	—	2.48	—	2.4	—	
			-24	4.5	3.94	—	3.8	—	3.7	—	
			-75	5.5	—	—	3.85	—	—	—	
Low-Level Output Voltage V _{OL}	V _{IH} or V _{IL}	#, *	0.05	1.5	—	0.1	—	0.1	—	0.1	V
			0.05	3	—	0.1	—	0.1	—	0.1	
			0.05	4.5	—	0.1	—	0.1	—	0.1	
			12	3	—	0.36	—	0.44	—	0.5	
			24	4.5	—	0.36	—	0.44	—	0.5	
			75	5.5	—	—	—	1.65	—	—	
Input Leakage Current I _I	V _{CC} or GND		5.5	—	±0.1	—	±1	—	±1	μA	
3-State Leakage Current I _{OZ}	V _{IH} or V _{IL} V _O = V _{CC} or GND		5.5	—	±0.5	—	±5	—	±10	μA	
Quiescent Supply Current, MSI I _{CC}	V _{CC} or GND	0	5.5	—	8	—	80	—	160	μA	

#Test one output at a time for a 1-second maximum duration. Measurement is made by forcing current and measuring voltage to minimize power dissipation.

* Test verifies a minimum 50-ohm transmission-line-drive capability at +85°C, 75 ohms at +125°C.

Technical Data

CD54/74AC540, CD54/74AC541 CD54/74ACT540, CD54/74ACT541

STATIC ELECTRICAL CHARACTERISTICS: ACT Series

CHARACTERISTICS	TEST CONDITIONS		V _{CC} (V)	AMBIENT TEMPERATURE (T _A) - °C						UNITS	
				+25		-40 to +85		-55 to +125			
	V _I (V)	I _O (mA)		MIN.	MAX.	MIN.	MAX.	MIN.	MAX.		
High-Level Input Voltage	V _{IH}		4.5 to 5.5	2	—	2	—	2	—	V	
Low-Level Input Voltage	V _{IL}		4.5 to 5.5	—	0.8	—	0.8	—	0.8	V	
High-Level Output Voltage	V _{OZH}	V _{IH} or V _{IL} #, *	-0.05	4.5	4.4	—	4.4	—	4.4	—	V
			-24	4.5	3.94	—	3.8	—	3.7	—	
			-75	5.5	—	—	3.85	—	—	—	
			-50	5.5	—	—	—	—	3.85	—	
Low-Level Output Voltage	V _{OL}	V _{IH} or V _{IL} #, *	0.05	4.5	—	0.1	—	0.1	—	0.1	V
			24	4.5	—	0.36	—	0.44	—	0.5	
			75	5.5	—	—	—	1.65	—	—	
			50	5.5	—	—	—	—	—	1.65	
Input Leakage Current	I _I	V _{CC} or GND	5.5	—	±0.1	—	±1	—	±1	μA	
3-State Leakage Current	I _{OZ}	V _{IH} or V _{IL} V _O = V _{CC} or GND	5.5	—	±0.5	—	±5	—	±10	μA	
Quiescent Supply Current, MSI	I _{CC}	V _{CC} or GND	0	5.5	—	8	—	80	—	160	μA
Additional Quiescent Supply Current per Input Pin TTL Inputs High 1 Unit Load	ΔI _{CC}	V _{CC} -2.1	4.5 to 5.5	—	2.4	—	2.8	—	3	mA	

#Test one output at a time for a 1-second maximum duration. Measurement is made by forcing current and measuring voltage to minimize power dissipation.

* Test verifies a minimum 50-ohm transmission-line-drive capability at +85°C, 75 ohms at +125°C.

ACT INPUT LOADING TABLE

INPUT	UNIT LOAD*	
	540	541
DATA	1.42	0.5
OE1, OE2	1.3	1.3

*Unit load is ΔI_{CC} limit specified in Static Characteristics Chart, e.g., 2.4 mA max. @ 25°C.

Technical Data

**CD54/74AC540, CD54/74AC541
CD54/74ACT540, CD54/74ACT541**

SWITCHING CHARACTERISTICS: AC Series; $t_r, t_f = 3 \text{ ns}$, $C_L = 50 \text{ pF}$

CHARACTERISTICS	SYMBOL	V_{CC} (V)	AMBIENT TEMPERATURE (T_A) - °C				UNITS
			-40 to +85		-55 to +125		
			MIN.	MAX.	MIN.	MAX.	
Propagation Delays: Data to Output AC540	t_{PLH}	1.5	—	77	—	85	ns
	t_{PHL}	3.3*	2.4	8.6	2.4	9.5	
AC541		5†	1.8	6.2	1.7	6.8	
Enable, to Output to Output	t_{PLH}	1.5	—	89	—	98	ns
	t_{PHL}	3.3	2.8	9.9	2.7	10.9	
		5	2.1	7.1	2	7.8	
Disable to Output to Output	t_{PZL}	1.5	—	136	—	150	ns
	t_{PZH}	3.3	4.6	16.4	4.5	18	
		5	3.1	10.9	3	12	
Power Dissipation Capacitance AC540 AC541	$C_{PD}‡$	—	60 Typ.		60 Typ.		pF
		—	60 Typ.		60 Typ.		
Min. (Valley) V_{OH} During Switching of Other Outputs (Output Under Test Not Switching)	V_{OHV} See Fig. 1	5	4 Typ. @ 25°C				V
Max. (Peak) V_{OL} During Switching of Other Outputs (Output Under Test Not Switching)	V_{OLP} See Fig. 1	5	1 Typ. @ 25°C				V
Input Capacitance	C_i	—	—	10	—	10	pF
3-State Output Capacitance	C_o	—	—	15	—	15	pF

SWITCHING CHARACTERISTICS: ACT Series; $t_r, t_f = 3 \text{ ns}$, $C_L = 50 \text{ pF}$

CHARACTERISTICS	SYMBOL	V_{CC} (V)	AMBIENT TEMPERATURE (T_A) - °C				UNITS
			-40 to +85		-55 to +125		
			MIN.	MAX.	MIN.	MAX.	
Propagation Delays: Data to Output ACT540	t_{PLH}	5†	1.9	6.5	1.8	7.2	ns
	t_{PHL}						
ACT541							
Enable to Output	t_{PLH}	5†	2.1	7.5	2.1	8.2	ns
	t_{PHL}						
Disable to Output	t_{PZL}	5	3.5	12.2	3.4	13.4	ns
	t_{PZH}						
Power Dissipation Capacitance ACT540 ACT541	$C_{PD}§$	—	60 Typ.		60 Typ.		pF
		—	60 Typ.		60 Typ.		
Min. (Valley) V_{OH} During Switching of Other Outputs (Output Under Test Not Switching)	V_{OHV} See Fig. 1	5	4 Typ. @ 25°C				V
Max. (Peak) V_{OL} During Switching of Other Outputs (Output Under Test Not Switching)	V_{OLP} See Fig. 1	5	1 Typ. @ 25°C				V
Input Capacitance	C_i	—	—	10	—	10	pF
3-State Output Capacitance	C_o	—	—	15	—	15	pF

*3.3 V: min. is @ 3.6 V
max. is @ 3 V

†5 V: min. is @ 5.5 V
max. is @ 4.5 V

§ C_{PD} is used to determine the dynamic power consumption, per channel.

For AC series, $P_D = V_{CC}^2 f_i (C_{PD} + C_L)$

For ACT series, $P_D = V_{CC}^2 f_i (C_{PD} + C_L) + V_{CC} \Delta I_{CC}$ where f_i = input frequency
 C_L = output load capacitance
 V_{CC} = supply voltage.

CD54/74AC540, CD54/74AC541 CD54/74ACT540, CD54/74ACT541

PARAMETER MEASUREMENT INFORMATION

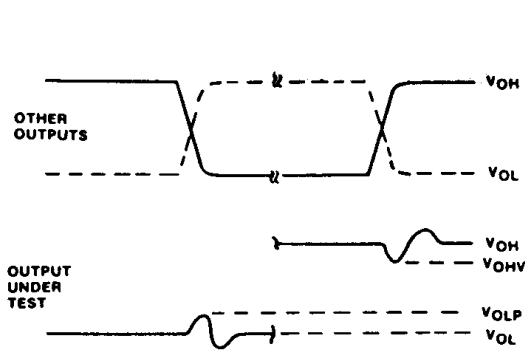

NOTES:

1. V_{OHV} AND V_{OLP} ARE MEASURED WITH RESPECT TO A GROUND REFERENCE NEAR THE OUTPUT UNDER TEST.
2. INPUT PULSES HAVE THE FOLLOWING CHARACTERISTICS:
 $PRR \leq 1$ MHz, $t_r = 3$ ns, $t_f = 3$ ns, SKEW 1 ns.
3. R.F. FIXTURE WITH 700-MHz DESIGN RULES REQUIRED. IC SHOULD BE SOLDERED INTO TEST BOARD AND BYPASSED WITH 0.1 μ F CAPACITOR. SCOPE AND PROBES REQUIRE 700-MHz BANDWIDTH.

92CS-42406

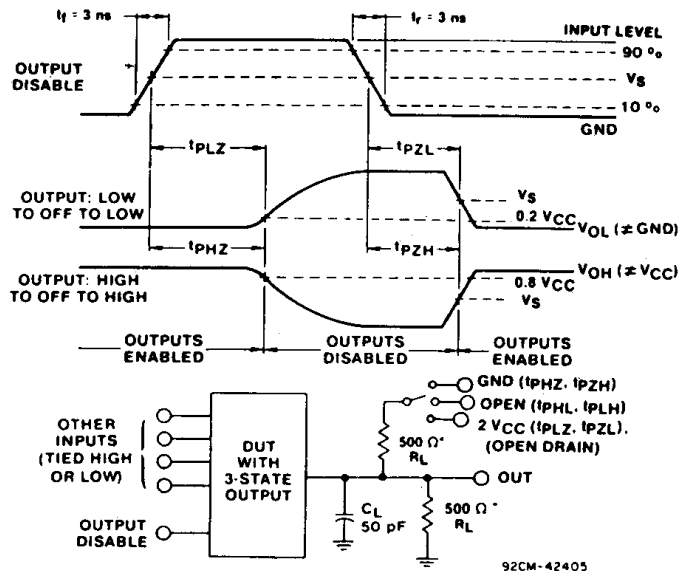

92CM-42405

*FOR AC SERIES ONLY: WHEN $V_{CC} = 1.5$ V, $R_L = 1$ k Ω

Fig. 1 - Simultaneous switching transient waveforms.

Fig. 2 - Three-state propagation delay waveforms and test circuit.

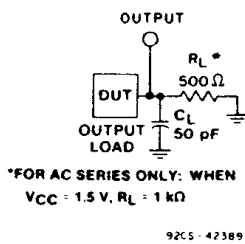

*FOR AC SERIES ONLY: WHEN $V_{CC} = 1.5$ V, $R_L = 1$ k Ω

92CS-42389

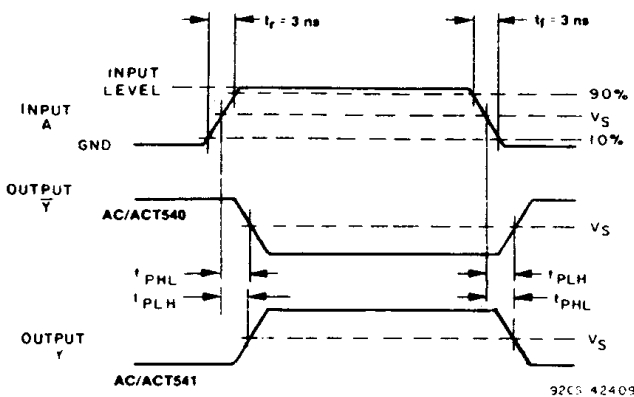

92CS-42409

Fig. 3 - Propagation delay times and test circuit.

	CD54/74AC	CD54/74ACT
Input Level	V_{CC}	3 V
Input Switching Voltage, V_S	$0.5 V_{CC}$	1.5 V
Output Switching Voltage, V_S	$0.5 V_{CC}$	$0.5 V_{CC}$

PACKAGING INFORMATION

Orderable Device	Status (1)	Package Type	Package Drawing	Pins	Package Qty	Eco Plan (2)	Lead/Ball Finish	MSL Peak Temp (3)	Samples (Requires Login)
CD54AC541F3A	ACTIVE	CDIP	J	20	1	TBD	A42	N / A for Pkg Type	
CD54ACT540F3A	ACTIVE	CDIP	J	20	1	TBD	A42	N / A for Pkg Type	
CD54ACT541F3A	ACTIVE	CDIP	J	20	1	TBD	A42	N / A for Pkg Type	
CD74AC540M	ACTIVE	SOIC	DW	20	25	Green (RoHS & no Sb/Br)	CU NIPDAU	Level-1-260C-UNLIM	
CD74AC540ME4	ACTIVE	SOIC	DW	20	25	Green (RoHS & no Sb/Br)	CU NIPDAU	Level-1-260C-UNLIM	
CD74AC540MG4	ACTIVE	SOIC	DW	20	25	Green (RoHS & no Sb/Br)	CU NIPDAU	Level-1-260C-UNLIM	
CD74AC541E	ACTIVE	PDIP	N	20	20	Pb-Free (RoHS)	CU NIPDAU	N / A for Pkg Type	
CD74AC541EE4	ACTIVE	PDIP	N	20	20	Pb-Free (RoHS)	CU NIPDAU	N / A for Pkg Type	
CD74AC541M	ACTIVE	SOIC	DW	20	25	Green (RoHS & no Sb/Br)	CU NIPDAU	Level-1-260C-UNLIM	
CD74AC541M96	ACTIVE	SOIC	DW	20	2000	Green (RoHS & no Sb/Br)	CU NIPDAU	Level-1-260C-UNLIM	
CD74AC541M96E4	ACTIVE	SOIC	DW	20	2000	Green (RoHS & no Sb/Br)	CU NIPDAU	Level-1-260C-UNLIM	
CD74AC541M96G4	ACTIVE	SOIC	DW	20	2000	Green (RoHS & no Sb/Br)	CU NIPDAU	Level-1-260C-UNLIM	
CD74AC541ME4	ACTIVE	SOIC	DW	20	25	Green (RoHS & no Sb/Br)	CU NIPDAU	Level-1-260C-UNLIM	
CD74AC541MG4	ACTIVE	SOIC	DW	20	25	Green (RoHS & no Sb/Br)	CU NIPDAU	Level-1-260C-UNLIM	
CD74AC541SM	OBSOLETE	SSOP	DB	20		TBD	Call TI	Call TI	
CD74AC541SM96	ACTIVE	SSOP	DB	20	2000	Green (RoHS & no Sb/Br)	CU NIPDAU	Level-1-260C-UNLIM	
CD74AC541SM96E4	ACTIVE	SSOP	DB	20	2000	Green (RoHS & no Sb/Br)	CU NIPDAU	Level-1-260C-UNLIM	
CD74AC541SM96G4	ACTIVE	SSOP	DB	20	2000	Green (RoHS & no Sb/Br)	CU NIPDAU	Level-1-260C-UNLIM	
CD74ACT540E	ACTIVE	PDIP	N	20	20	Pb-Free (RoHS)	CU NIPDAU	N / A for Pkg Type	

Orderable Device	Status (1)	Package Type	Package Drawing	Pins	Package Qty	Eco Plan (2)	Lead/Ball Finish	MSL Peak Temp (3)	Samples (Requires Login)
CD74ACT540EE4	ACTIVE	PDIP	N	20	20	Pb-Free (RoHS)	CU NIPDAU	N / A for Pkg Type	
CD74ACT540M	ACTIVE	SOIC	DW	20	25	Green (RoHS & no Sb/Br)	CU NIPDAU	Level-1-260C-UNLIM	
CD74ACT540M96	ACTIVE	SOIC	DW	20	2000	Green (RoHS & no Sb/Br)	CU NIPDAU	Level-1-260C-UNLIM	
CD74ACT540M96E4	ACTIVE	SOIC	DW	20	2000	Green (RoHS & no Sb/Br)	CU NIPDAU	Level-1-260C-UNLIM	
CD74ACT540M96G4	ACTIVE	SOIC	DW	20	2000	Green (RoHS & no Sb/Br)	CU NIPDAU	Level-1-260C-UNLIM	
CD74ACT540ME4	ACTIVE	SOIC	DW	20	25	Green (RoHS & no Sb/Br)	CU NIPDAU	Level-1-260C-UNLIM	
CD74ACT540MG4	ACTIVE	SOIC	DW	20	25	Green (RoHS & no Sb/Br)	CU NIPDAU	Level-1-260C-UNLIM	
CD74ACT541E	ACTIVE	PDIP	N	20	20	Pb-Free (RoHS)	CU NIPDAU	N / A for Pkg Type	
CD74ACT541EE4	ACTIVE	PDIP	N	20	20	Pb-Free (RoHS)	CU NIPDAU	N / A for Pkg Type	
CD74ACT541M	ACTIVE	SOIC	DW	20	25	Green (RoHS & no Sb/Br)	CU NIPDAU	Level-1-260C-UNLIM	
CD74ACT541M96	ACTIVE	SOIC	DW	20	2000	Green (RoHS & no Sb/Br)	CU NIPDAU	Level-1-260C-UNLIM	
CD74ACT541M96E4	ACTIVE	SOIC	DW	20	2000	Green (RoHS & no Sb/Br)	CU NIPDAU	Level-1-260C-UNLIM	
CD74ACT541M96G4	ACTIVE	SOIC	DW	20	2000	Green (RoHS & no Sb/Br)	CU NIPDAU	Level-1-260C-UNLIM	
CD74ACT541ME4	ACTIVE	SOIC	DW	20	25	Green (RoHS & no Sb/Br)	CU NIPDAU	Level-1-260C-UNLIM	
CD74ACT541MG4	ACTIVE	SOIC	DW	20	25	Green (RoHS & no Sb/Br)	CU NIPDAU	Level-1-260C-UNLIM	
CD74ACT541SM	OBSOLETE	SSOP	DB	20		TBD	Call TI	Call TI	
CD74ACT541SM96	ACTIVE	SSOP	DB	20	2000	Green (RoHS & no Sb/Br)	CU NIPDAU	Level-1-260C-UNLIM	
CD74ACT541SM96E4	ACTIVE	SSOP	DB	20	2000	Green (RoHS & no Sb/Br)	CU NIPDAU	Level-1-260C-UNLIM	

Orderable Device	Status (1)	Package Type	Package Drawing	Pins	Package Qty	Eco Plan (2)	Lead/Ball Finish	MSL Peak Temp (3)	Samples (Requires Login)
CD74ACT541SM96G4	ACTIVE	SSOP	DB	20	2000	Green (RoHS & no Sb/Br)	CU NIPDAU	Level-1-260C-UNLIM	

(1) The marketing status values are defined as follows:

ACTIVE: Product device recommended for new designs.

LIFEBUY: TI has announced that the device will be discontinued, and a lifetime-buy period is in effect.

NRND: Not recommended for new designs. Device is in production to support existing customers, but TI does not recommend using this part in a new design.

PREVIEW: Device has been announced but is not in production. Samples may or may not be available.

OBsolete: TI has discontinued the production of the device.

(2) Eco Plan - The planned eco-friendly classification: Pb-Free (RoHS), Pb-Free (RoHS Exempt), or Green (RoHS & no Sb/Br) - please check <http://www.ti.com/productcontent> for the latest availability information and additional product content details.

TBD: The Pb-Free/Green conversion plan has not been defined.

Pb-Free (RoHS): TI's terms "Lead-Free" or "Pb-Free" mean semiconductor products that are compatible with the current RoHS requirements for all 6 substances, including the requirement that lead not exceed 0.1% by weight in homogeneous materials. Where designed to be soldered at high temperatures, TI Pb-Free products are suitable for use in specified lead-free processes.

Pb-Free (RoHS Exempt): This component has a RoHS exemption for either 1) lead-based flip-chip solder bumps used between the die and package, or 2) lead-based die adhesive used between the die and leadframe. The component is otherwise considered Pb-Free (RoHS compatible) as defined above.

Green (RoHS & no Sb/Br): TI defines "Green" to mean Pb-Free (RoHS compatible), and free of Bromine (Br) and Antimony (Sb) based flame retardants (Br or Sb do not exceed 0.1% by weight in homogeneous material)

(3) MSL, Peak Temp. -- The Moisture Sensitivity Level rating according to the JEDEC industry standard classifications, and peak solder temperature.

Important Information and Disclaimer: The information provided on this page represents TI's knowledge and belief as of the date that it is provided. TI bases its knowledge and belief on information provided by third parties, and makes no representation or warranty as to the accuracy of such information. Efforts are underway to better integrate information from third parties. TI has taken and continues to take reasonable steps to provide representative and accurate information but may not have conducted destructive testing or chemical analysis on incoming materials and chemicals. TI and TI suppliers consider certain information to be proprietary, and thus CAS numbers and other limited information may not be available for release.

In no event shall TI's liability arising out of such information exceed the total purchase price of the TI part(s) at issue in this document sold by TI to Customer on an annual basis.

OTHER QUALIFIED VERSIONS OF CD54AC541, CD54ACT540, CD54ACT541, CD74AC541, CD74ACT540, CD74ACT541 :

● Catalog: [CD74AC541](#), [CD74ACT540](#), [CD74ACT541](#)

● Military: [CD54AC541](#), [CD54ACT540](#), [CD54ACT541](#)

NOTE: Qualified Version Definitions:

● Catalog - TI's standard catalog product

- Military - QML certified for Military and Defense Applications

TAPE AND REEL INFORMATION
REEL DIMENSIONS

TAPE DIMENSIONS

A0	Dimension designed to accommodate the component width
B0	Dimension designed to accommodate the component length
K0	Dimension designed to accommodate the component thickness
W	Overall width of the carrier tape
P1	Pitch between successive cavity centers

TAPE AND REEL INFORMATION

*All dimensions are nominal

Device	Package Type	Package Drawing	Pins	SPQ	Reel Diameter (mm)	Reel Width W1 (mm)	A0 (mm)	B0 (mm)	K0 (mm)	P1 (mm)	W (mm)	Pin1 Quadrant
CD74AC541M96	SOIC	DW	20	2000	330.0	24.4	10.8	13.0	2.7	12.0	24.0	Q1
CD74AC541SM96	SSOP	DB	20	2000	330.0	16.4	8.2	7.5	2.5	12.0	16.0	Q1
CD74ACT540M96	SOIC	DW	20	2000	330.0	24.4	10.8	13.0	2.7	12.0	24.0	Q1
CD74ACT541M96	SOIC	DW	20	2000	330.0	24.4	10.8	13.0	2.7	12.0	24.0	Q1
CD74ACT541SM96	SSOP	DB	20	2000	330.0	16.4	8.2	7.5	2.5	12.0	16.0	Q1

TAPE AND REEL BOX DIMENSIONS

*All dimensions are nominal

Device	Package Type	Package Drawing	Pins	SPQ	Length (mm)	Width (mm)	Height (mm)
CD74AC541M96	SOIC	DW	20	2000	367.0	367.0	45.0
CD74AC541SM96	SSOP	DB	20	2000	367.0	367.0	38.0
CD74ACT540M96	SOIC	DW	20	2000	367.0	367.0	45.0
CD74ACT541M96	SOIC	DW	20	2000	367.0	367.0	45.0
CD74ACT541SM96	SSOP	DB	20	2000	367.0	367.0	38.0

J (R-GDIP-T**)

14 LEADS SHOWN

CERAMIC DUAL IN-LINE PACKAGE



DIM \ PINS **	14	16	18	20
A	0.300 (7,62) BSC	0.300 (7,62) BSC	0.300 (7,62) BSC	0.300 (7,62) BSC
B MAX	0.785 (19,94)	.840 (21,34)	0.960 (24,38)	1.060 (26,92)
B MIN	—	—	—	—
C MAX	0.300 (7,62)	0.300 (7,62)	0.310 (7,87)	0.300 (7,62)
C MIN	0.245 (6,22)	0.245 (6,22)	0.220 (5,59)	0.245 (6,22)



4040083/F 03/03

- NOTES:
- All linear dimensions are in inches (millimeters).
 - This drawing is subject to change without notice.
 - This package is hermetically sealed with a ceramic lid using glass frit.
 - Index point is provided on cap for terminal identification only on press ceramic glass frit seal only.
 - Falls within MIL STD 1835 GDIP1-T14, GDIP1-T16, GDIP1-T18 and GDIP1-T20.

N (R-PDIP-T**)

PLASTIC DUAL-IN-LINE PACKAGE

16 PINS SHOWN



- NOTES:
- A. All linear dimensions are in inches (millimeters).
 - B. This drawing is subject to change without notice.
 - C Falls within JEDEC MS-001, except 18 and 20 pin minimum body length (Dim A).
 - D The 20 pin end lead shoulder width is a vendor option, either half or full width.

4040049/E 12/2002

DW (R-PDSO-G20)

PLASTIC SMALL OUTLINE



- NOTES:
- A. All linear dimensions are in inches (millimeters). Dimensioning and tolerancing per ASME Y14.5M-1994.
 - B. This drawing is subject to change without notice.
 - C. Body dimensions do not include mold flash or protrusion not to exceed 0.006 (0,15).
 - D. Falls within JEDEC MS-013 variation AC.

DB (R-PDSO-G**)

PLASTIC SMALL-OUTLINE

28 PINS SHOWN



- NOTES: A. All linear dimensions are in millimeters.
 B. This drawing is subject to change without notice.
 C. Body dimensions do not include mold flash or protrusion not to exceed 0,15.
 D. Falls within JEDEC MO-150

IMPORTANT NOTICE

Texas Instruments Incorporated and its subsidiaries (TI) reserve the right to make corrections, enhancements, improvements and other changes to its semiconductor products and services per JESD46, latest issue, and to discontinue any product or service per JESD48, latest issue. Buyers should obtain the latest relevant information before placing orders and should verify that such information is current and complete. All semiconductor products (also referred to herein as "components") are sold subject to TI's terms and conditions of sale supplied at the time of order acknowledgment.

TI warrants performance of its components to the specifications applicable at the time of sale, in accordance with the warranty in TI's terms and conditions of sale of semiconductor products. Testing and other quality control techniques are used to the extent TI deems necessary to support this warranty. Except where mandated by applicable law, testing of all parameters of each component is not necessarily performed.

TI assumes no liability for applications assistance or the design of Buyers' products. Buyers are responsible for their products and applications using TI components. To minimize the risks associated with Buyers' products and applications, Buyers should provide adequate design and operating safeguards.

TI does not warrant or represent that any license, either express or implied, is granted under any patent right, copyright, mask work right, or other intellectual property right relating to any combination, machine, or process in which TI components or services are used. Information published by TI regarding third-party products or services does not constitute a license to use such products or services or a warranty or endorsement thereof. Use of such information may require a license from a third party under the patents or other intellectual property of the third party, or a license from TI under the patents or other intellectual property of TI.

Reproduction of significant portions of TI information in TI data books or data sheets is permissible only if reproduction is without alteration and is accompanied by all associated warranties, conditions, limitations, and notices. TI is not responsible or liable for such altered documentation. Information of third parties may be subject to additional restrictions.

Resale of TI components or services with statements different from or beyond the parameters stated by TI for that component or service voids all express and any implied warranties for the associated TI component or service and is an unfair and deceptive business practice. TI is not responsible or liable for any such statements.

Buyer acknowledges and agrees that it is solely responsible for compliance with all legal, regulatory and safety-related requirements concerning its products, and any use of TI components in its applications, notwithstanding any applications-related information or support that may be provided by TI. Buyer represents and agrees that it has all the necessary expertise to create and implement safeguards which anticipate dangerous consequences of failures, monitor failures and their consequences, lessen the likelihood of failures that might cause harm and take appropriate remedial actions. Buyer will fully indemnify TI and its representatives against any damages arising out of the use of any TI components in safety-critical applications.

In some cases, TI components may be promoted specifically to facilitate safety-related applications. With such components, TI's goal is to help enable customers to design and create their own end-product solutions that meet applicable functional safety standards and requirements. Nonetheless, such components are subject to these terms.

No TI components are authorized for use in FDA Class III (or similar life-critical medical equipment) unless authorized officers of the parties have executed a special agreement specifically governing such use.

Only those TI components which TI has specifically designated as military grade or "enhanced plastic" are designed and intended for use in military/aerospace applications or environments. Buyer acknowledges and agrees that any military or aerospace use of TI components which have **not** been so designated is solely at the Buyer's risk, and that Buyer is solely responsible for compliance with all legal and regulatory requirements in connection with such use.

TI has specifically designated certain components as meeting ISO/TS16949 requirements, mainly for automotive use. In any case of use of non-designated products, TI will not be responsible for any failure to meet ISO/TS16949.

Products

Audio	www.ti.com/audio
Amplifiers	amplifier.ti.com
Data Converters	dataconverter.ti.com
DLP® Products	www.dlp.com
DSP	dsp.ti.com
Clocks and Timers	www.ti.com/clocks
Interface	interface.ti.com
Logic	logic.ti.com
Power Mgmt	power.ti.com
Microcontrollers	microcontroller.ti.com
RFID	www.ti-rfid.com
OMAP Applications Processors	www.ti.com/omap
Wireless Connectivity	www.ti.com/wirelessconnectivity

Applications

Automotive and Transportation	www.ti.com/automotive
Communications and Telecom	www.ti.com/communications
Computers and Peripherals	www.ti.com/computers
Consumer Electronics	www.ti.com/consumer-apps
Energy and Lighting	www.ti.com/energy
Industrial	www.ti.com/industrial
Medical	www.ti.com/medical
Security	www.ti.com/security
Space, Avionics and Defense	www.ti.com/space-avionics-defense
Video and Imaging	www.ti.com/video

TI E2E Community

e2e.ti.com