

SINGLE-CELL LI-ION AND LI-POL CHARGE MANAGEMENT IC FOR OFFLINE APPLICATIONS

FEATURES

- **Designed for Off-Line Charger Design for Single-Cell Li-Ion Packs**
- **Provides Control Feedback to a Primary-Side Controller**
- **Robust Battery Insertion and Removal Detection**
- **Charge Current and Voltage Regulation Feedback to Primary-Side for High-Accuracy Charging**
- **Charge Termination by Minimum Current and Time**
- **Pre-Charge Conditioning Regulator with Safety Timer**
- **Charge Status Outputs for LED or Host Processor Interface Indicates Charge-in-Progress, Charge Completion, and Fault Conditions**
- **Temperature Monitoring Before and During Charge**
- **Short-Circuit Protection**
- **Small, 14-Pin TSSOP Package**

APPLICATIONS

- **Cradle Chargers for Digital Cameras**
- **Desktop Chargers**
- **Handheld Devices**

DESCRIPTION

The bq24901 Li-Ion charge management devices are designed specifically for off-line charger applications. The bq24901 resides on the secondary-side of the transformer and provides the control feedback to a variety of primary side controllers. The bq24901 offers current or voltage regulation feedback, temperature monitoring, charge status, and adjustable charge termination, in a single monolithic device. During battery-absent or charge-complete conditions, the bq24901 continuously regulates the secondary-side voltage, used as V_{CC} supply to the device.

The bq24901 features a time-limited pre-conditioning phase to condition deeply discharged cells. The pre-conditioning phase is achieved by linear regulation in the secondary side. Following preconditioning, the bq24901 regulates the charge current to the value set by the external current sense resistor. Once the battery reaches the charge voltage, the voltage regulation loop takes over and completes the charge cycle. The accuracy of the voltage regulation is better than $\pm 30\text{mV}$. Charge is terminated based on minimum current. The minimum current level is set through TADJ pin. An internal five-hour charge timer provides a backup for charge termination.

The bq24901 is designed to reliably detect battery insertion and removal conditions, including packs with open protectors. Other standard features include a recharge feature activated when the battery voltage falls below the V_{RCH} threshold.

DESCRIPTION (continued)

In addition to the standard features, the bq24901 offers battery temperature monitoring and status display. The temperature-sense circuit continuously measures battery temperature using an external thermistor and suspends charge until the battery temperature is within the user-defined thresholds. The STAT pins indicate conditions of operation of the charger. These outputs can be used to drive an LED or interface to a host microcontroller.



These devices have limited built-in ESD protection. The leads should be shorted together or the device placed in conductive foam during storage or handling to prevent electrostatic damage to the MOS gates.

ORDERING INFORMATION

T _A	CHARGE REGULATION VOLTAGE	PACKAGE DEVICES(1)	TOP SIDE MARKINGS
-20°C to 85°C	4.2 V	bq24901PW	bq24901

(1) The PW package is also available taped and reeled. Add an R suffix to the device type (i.e., bq24901PWR) for quantities of 2,500 devices per reel.

PACKAGE DISSIPATION RATING TABLE

PACKAGE	θ _{JA}	T _A ≤ 25°C POWER RATING	DERATING FACTOR ABOVE T _A = 25°C
PW	110°C/ W	907 mW	9.07 mW/°C/

ABSOLUTE MAXIMUM RATINGS

over operating free-air temperature range unless otherwise noted(1)

		bq24901	UNIT
Supply voltage, V _{CC}	with respect to V _{SS}	11.5	V
Input voltage range, V _I	SNS, BAT, STAT1, STAT2, VCOMP, ICOMP, SCOMP, OPTD, CC (all with respect to V _{SS})	11.5	V
	TADJ, VREF (all with respect to V _{SS})	7	
	TS (with respect to V _{SS})	-0.3 to V _{CC} + 0.3 V	
Output sink/source current, I _O	STAT1, STAT2, OPTD	20	mA
	CC	80	
	VREF	1	
Operating free-air temperature range, T _A		-40 to 100	°C
Junction temperature range, T _J		-40 to 125	
Storage temperature, T _{stg}		-65 to 150	
Lead temperature 1,6 mm (1/16 inch) from case for 10 seconds		300	

(1) Stresses beyond those listed under "absolute maximum ratings" may cause permanent damage to the device. These are stress ratings only, and functional operation of the device at these or any other conditions beyond those indicated under "recommended operating conditions" is not implied. Exposure to absolute-maximum-rated conditions for extended periods may affect device reliability.

RECOMMENDED OPERATING CONDITIONS

	MIN	MAX	UNIT
Supply voltage, V _{CC}	3	10	V
Operating free-air temperature, T _A	-20	85	°C

ELECTRICAL CHARACTERISTICS

Over recommended operating free-air temperature and supply voltage (unless otherwise noted)

PARAMETER		TEST CONDITIONS	MIN	TYP	MAX	UNIT
SUPPLY CURRENT						
$I_{CC}(V_{CC})$	Input current	$V_{CC} > V_{CC}(\text{min})$			2	mA
$I_{B}(\text{BAT})$	Input bias current on BAT pin	$V_{I}(\text{BAT}) > V_{O}(\text{REG})$, when not in charge			1	μA
$I_{B}(\text{TS})$	Input bias current on TS pin	$V_{I}(\text{TS}) = 2.5 \text{ V}$			1	
$I_{B}(\text{SNS})$	Input bias current on SNS pin	$V_{CC} = 6 \text{ V}$, $V_{I}(\text{SNS}) = 6 \text{ V}$ when not in charge			1	
$I_{B}(\text{TADJ})$	Input bias current on TADJ pin	$V_{I}(\text{TADJ}) = V_{\text{REF}}$			1	
BATTERY VOLTAGE and VCC REGULATION						
$V_{O}(\text{REG})$	Output voltage	$0^{\circ}\text{C} \leq T_{A} \leq 70^{\circ}\text{C}$	4.17	4.20	4.23	V
V_{CC}	Supply voltage		5.8	6.0	6.3	
CURRENT REGULATION						
$V_{\text{(SNS)}}$	Current regulation threshold voltage	Voltage at pin SNS relative to BAT, $0^{\circ}\text{C} \leq T_{A} \leq 70^{\circ}\text{C}$, $V_{\text{(LOWV)}} \leq V_{\text{(SNS)}} \leq V_{O}(\text{REG})$	184	200	216	mV
	Input common mode range on SNS pin		$V_{\text{(UVT)}}$		V_{CC}	V
PRE-CHARGE AND SHORT-CIRCUIT CURRENT REGULATION						
	Pre-charge voltage threshold	Voltage at pin SNS relative to BAT pin, $0^{\circ}\text{C} \leq T_{A} \leq 70^{\circ}\text{C}$ $V_{\text{(UVT)}} \leq V_{I}(\text{BAT}) \leq V_{\text{(LOWV)}}$	10	20	30	mV
I_{SC}	Short-circuit current	$0^{\circ}\text{C} \leq T_{A} \leq 70^{\circ}\text{C}$, $0 \leq V_{I}(\text{BAT}) \leq V_{\text{(UVT)}}$	5.4		30.0	mA
CHARGE TERMINATION DETECTION						
$V_{\text{(ITERM)}}$	Charge termination current detect threshold	Voltage at pin SNS relative to BAT pin, $0^{\circ}\text{C} \leq T_{A} \leq 70^{\circ}\text{C}$ TADJ pin tied to VREF pin, $V_{I}(\text{SNS}) = V_{O}(\text{REG})$ $V_{I}(\text{BAT}) > V_{\text{(RCH)}}$	16	20	24	mV
		Voltage at pin SNS relative to BAT pin, $0^{\circ}\text{C} \leq T_{A} \leq 70^{\circ}\text{C}$ TADJ pin tied to VSS pin, $V_{I}(\text{SNS}) = V_{O}(\text{REG})$ $V_{I}(\text{BAT}) > V_{\text{(RCH)}}$	7.5	10.0	12.5	
$V_{\text{(EN-TERM)}}$	Enable termination voltage	$(V_{I}(\text{SNS}) - V_{I}(\text{BAT})) < V_{\text{(ITERM)}}$, V_{BAT} increasing above threshold	$V_{O}(\text{REG}) - 210$	$V_{O}(\text{REG}) - 160$	$V_{O}(\text{REG}) - 110$	V
$t_{\text{(TRMDET2)}}$	Falling-edge delay for termination detection	$(V_{\text{SNS}} - V_{\text{BAT}})$ increasing above threshold, $V_{I}(\text{BAT}) > V_{\text{(EN-TERM)}}$, 100 ns fall time 2 mV overdrive		100		μs
$t_{\text{(TRMDET1)}}$	Rising-edge delay for termination detection	$(V_{\text{SNS}} - V_{\text{BAT}})$ increasing above threshold, $V_{I}(\text{BAT}) > V_{\text{(EN-TERM)}}$, 100 ns fall time 2 mV overdrive		20		ms
TEMPERATURE COMPARATOR						
$V_{\text{(LTF)}}$	Cold temperature threshold voltage	V_{TS} , $V_{CC} \geq 3.5 \text{ V}$	72.6	73.5	74.1	%VCC
$V_{\text{(HTF)}}$	Hot temperature threshold voltage	V_{TS} , $V_{CC} \geq 3.5 \text{ V}$	33.7	34.4	35.1	
$V_{\text{(TCO)}}$	Cutoff temperature threshold voltage	V_{TS} , $V_{CC} \geq 3.5 \text{ V}$	28.7	29.3	29.9	
	LTF hysteresis	Hysteresis for LTF threshold voltage	0.1	0.6	1.1	
LOW BATTERY VOLTAGE (LOWV) THRESHOLD COMPARATOR						
$V_{\text{(LOWV)}}$			3.00	3.05	3.15	V

(1) Ensured by design. Not production tested.

ELECTRICAL CHARACTERISTICS (continued)

Over recommended operating free-air temperature and supply voltage (unless otherwise noted)

PARAMETER	TEST CONDITIONS	MIN	TYP	MAX	UNIT
BATTERY RECHARGE THRESHOLD (V_{RCH}) COMPARATOR					
V _(RCH) Recharge threshold voltage		V _{O(REG)} – 0.24		V _{O(REG)} – 0.12	V
POWER-ON RESET (POR)					
V _(POR) POR threshold voltage		2.60	2.70	2.85	V
TIMERS					
t _(PRECHG) Precharge time	V _{I(BAT)} < V _(LOWV)	1,350	1,800	2,250	s
t _(CHG) Charge time	V _(LOWV) < V _{I(BAT)} < V _{O(REG)} , V _{I(SNS)} – V _{I(BAT)} < V _(ITERM)	13,500	18,000	22,500	
OPTO-DRIVER PIN (OPTD)					
V _{SAT(OPTD)} Output saturation voltage	I _{O(OPTD)} = 10 mA			100	mV
I _(OPTDLKG) Opto-driver leakage current	V _(OPTD) = 5 V, V _{I(BAT)} < V _{O(REG)} V _{CC} = 5.8 V, (V _{I(SNS)} – V _{I(BAT)}) < 184 mV			100	μA
gm Transconductance	I _{O(OPTD)} = 5 mA	5	500		S
Gain-bandwidth product	I _{O(OPTD)} = 5 mA, R _{LOAD} = 100 Ω		1		MHz
DISCHARGE CURRENT, DISCHARGE VOLTAGE, CONDITION CURRENT AND WAKE CURRENT					
I _(DISCHG) Discharge current	1 V ≤ V _{I(BAT)} ≤ 4.2 V	60	300	800	μA
t _(DISCHG1) Discharge time 1		250	310	370	ms
t _(DISCHG2) Discharge time 2		20	25	30	
V _(DISCHG) Discharge voltage ⁽¹⁾		1.5	2.0	2.5	V
I _(DETECT) Battery detection current	I _(DETECT_min) at V _{CC} = 5.8 V, V _{I(BAT)} = 4.2 V	0.8			mA
	I _(DETECT_max) at V _{CC} = 6 V, V _{I(BAT)} = 0 V			30	
I _(WK_SRC) Wake current, source 1	I _(WK_SRC_min) at V _{CC} = 5.8 V, V _{I(BAT)} = 4.2 V	0.8			
	I _(WK_SRC_max) at V _{CC} = 6 V, V _{I(BAT)} = 0 V			30	
I _(WK_SINK) Wake current, source 2	I _(WK_SINK_min) at V _{CC} = 5.8 V, V _{I(BAT)} = 4.2 V	0			μA
	I _(WK_SINK_max) at V _{CC} = 6 V, V _{I(BAT)} = 0 V			1000	
t _(WK) Wake time		100	125	150	ms
CHARGE STATUS OUTPUT (STAT1/STAT2)					
V _{OL(STATx)} Low-level output saturation voltage	I _{O(STATx)} = 10 mA, V _{CC} ≥ 3.5 V			0.5	V
VOLTAGE REFERENCE OUTPUT (VREF)					
VREF voltage threshold	0 V < I _{O(VREF)} < 500 μA, 0°C ≤ T _A ≤ 70°C	1.18		1.22	V
CHARGE CONTROL OUTPUT (CC)					
V _{OL} Low-level output voltage (FstChg)	I _{O(CC)} = 40 mA (sink)			0.45	V
C _{OUT} Output capacitance	LDO to BAT, LDO to VSS	0.1		10.0	μF
UNDERVOLTAGE THRESHOLD SHORT-CIRCUIT PROTECTION					
V _(UVT) Undervoltage threshold voltage		2.00		2.15	V

(1) Ensured by design. Not production tested.

**PW PACKAGE†
(TOP VIEW)**

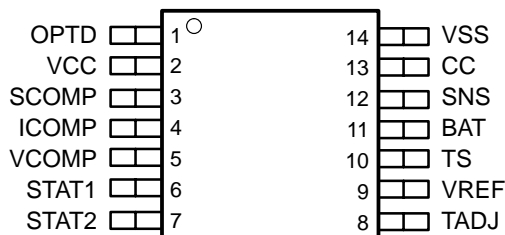

TERMINAL FUNCTIONS

TERMINAL		I/O	DESCRIPTION
NAME	NO.		
BAT	11	I	Battery voltage sense input. This input is tied directly to the positive side of the battery pack.
CC	13	O	Charge control output. CC is an open-drain pulldown output that is used to drive an external pass transistor for charge current and voltage control
ICOMP	4	I	Current loop compensation. This is the compensation for the fast charge current regulation loop.
OPTD	1	O	Optocoupler driver output. This open-collector output is used to provide feedback to the primary side by driving an external optocoupler.
SCOMP	3	I	Supply loop compensation. This is the compensation for the V_{CC} supply regulation loop.
SNS	12	I	Current sense input. Battery current is sensed via the voltage developed on this pin by an external sense resistor.
STAT1	6	O	Charge status output 1 (open drain)
STAT2	7	O	Charge status output 2 (open drain)
TADJ	8	I	Termination adjust. This input is used to set the minimum current termination level during voltage regulation phase.
TS	10	I	Temperature sense Input. Input for an external battery temperature monitoring.
VCC	2	I	V_{CC} supply input.
VCOMP	5	I	Voltage loop compensation. This is the compensation for the battery regulation loop
VREF	9	O	Voltage reference output. This buffered output provides the internal bandgap voltage.
VSS	14	–	Ground input.

APPLICATION INFORMATION

The bq24901 supports a precision current and voltage regulated li-ion charging system suitable for single-cells. Figure 1 shows the typical application diagram, Figure 2 shows a typical charge profile, and Figure 3 shows an operational flow chart.

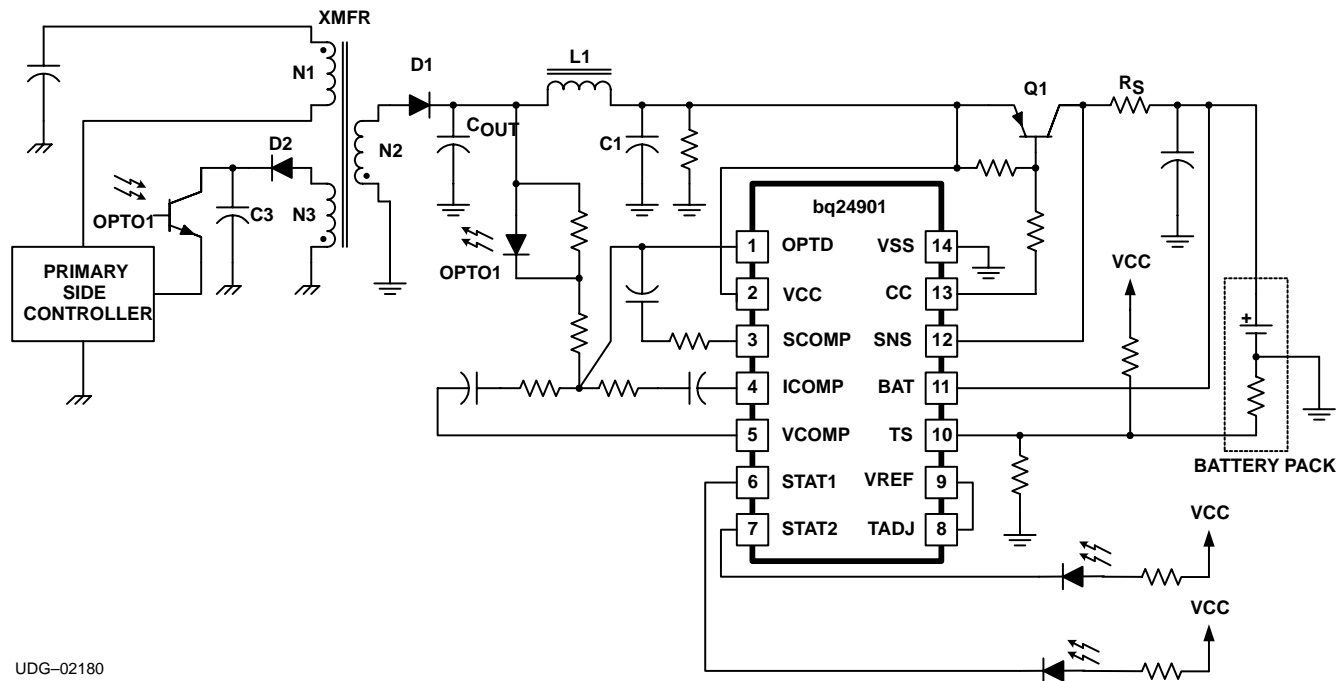

UDG-02180

Figure 1. Typical Application Diagram

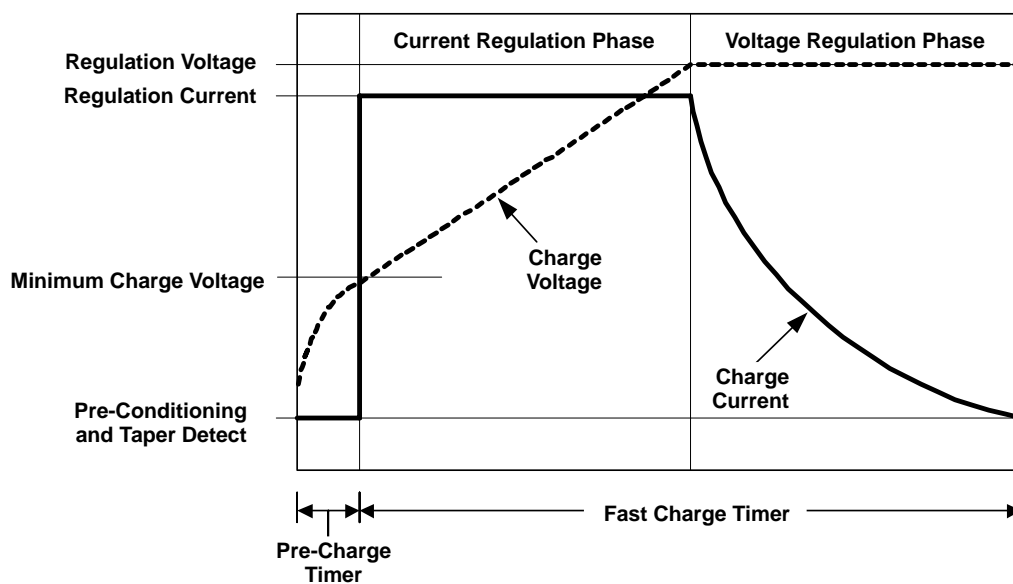

Figure 2. Typical Charge Profile

APPLICATION INFORMATION

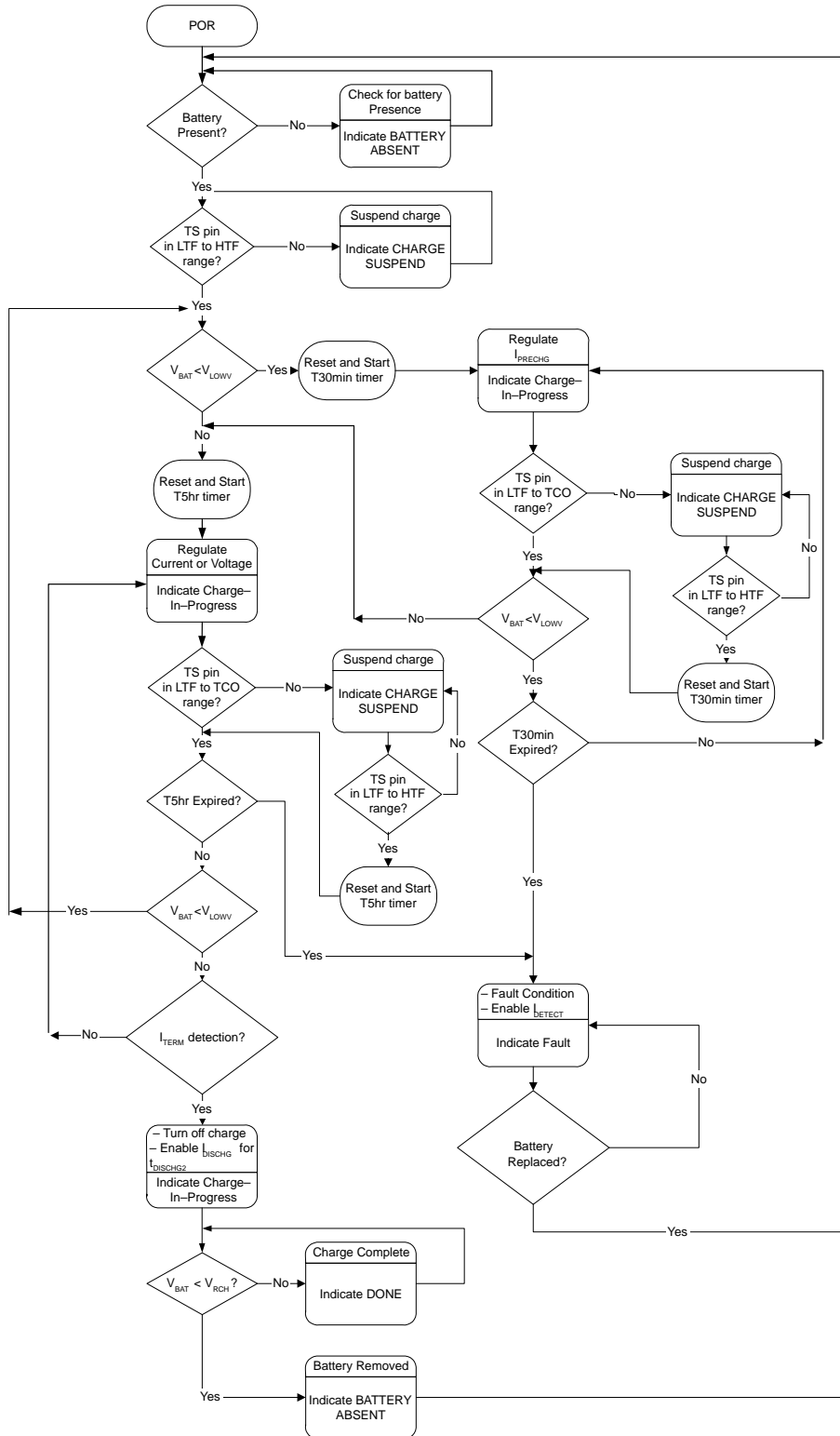

Figure 3. Operational Flow Chart

APPLICATION INFORMATION

Charge Qualification and Pre-Conditioning

The bq24901 starts a charge cycle when power is applied and a battery is present. Charge qualification is based on battery temperature and voltage. The device suspends charge if the battery temperature is outside the V_{LTF} to V_{HTF} and waits until the battery temperature is within the allowed range. The device also checks the battery voltage. If the battery voltage is below the low-voltage threshold, V_{LOWV} , the device use pre-conditioning current, I_{PRECHG} , to charge the battery.

Temperature Sense (TS) Input

The bq24901 continuously monitors battery temperature by measuring the voltage between the TS pin and Vss. A negative temperature coefficient thermistor (NTC) and an external voltage divider typically develop this voltage. The bq24901 compares this voltage against its internal thresholds to determine if charging is allowed. To initiate a charge cycle, the battery temperature must be within the V_{LTF} to V_{HTF} thresholds. If battery temperature is outside of this range, the device suspends charge and waits until the battery temperature is within the V_{LTF} to V_{HTF} range. During the charge cycle (both pre-charge and fast charge) the battery temperature must be within the V_{LTF} to V_{TCO} thresholds. If battery temperature is outside of this range, the bq24901 suspends charge and waits until the battery temperature is within the V_{LTF} to V_{HTF} range. The device suspends charge by turning off the CC pin and holding the timer value (i.e. timers are not reset during a suspend condition). Figure 4 summarizes this operation.

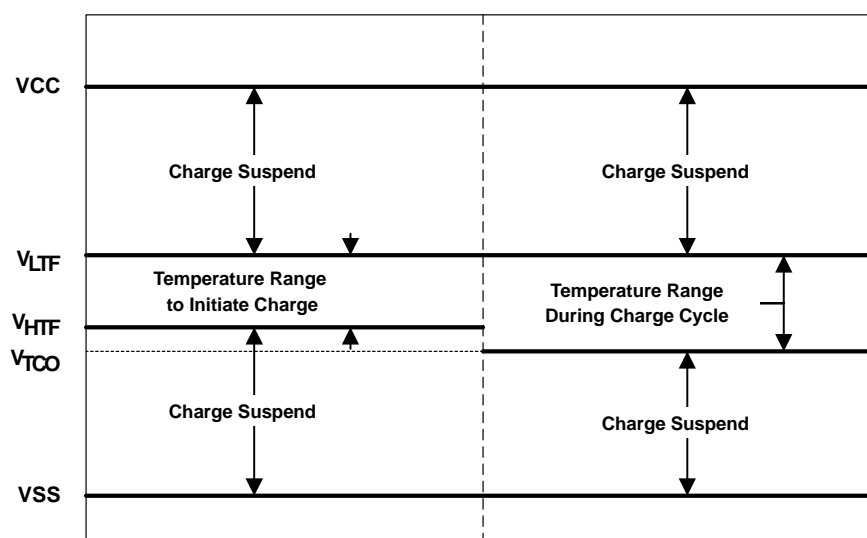

Figure 4. Temperature Sense Input Thresholds

APPLICATION INFORMATION**VCC Regulation**

During the following conditions the bq24901 regulates the V_{CC} power and the device remains active. Loop compensation for V_{CC} regulation is achieved through SCOMP pin.

- Battery absent condition
- Pre-charge
- Charge suspend
- Fault
- Done

Voltage Monitoring and Regulation

Voltage regulation feedback is through pin BAT. This input is tied directly to the positive side of the battery pack. Loop compensation for voltage regulation is achieved through VCOMP pin.

Current Regulation

The bq24901 provides current regulation while the battery pack voltage is less than the regulation voltage, V_{REG} . The device monitors charge current at the SNS input by the voltage drop across an external sense-resistor, R_{SNS} , in series with the battery pack. Charge current feedback, applied through pin SNS, maintains regulation around a threshold of V_{SNS} . The formula in equation (1) calculates the value of the sense resistor.

$$R_{SNS} = \frac{V_{(SNS)}}{I_{(CHG)}} \quad (1)$$

where:

- $I_{(CHG)}$ is the desired charging circuit

Loop compensation for current regulation is accomplished via the ICOMP pin.

APPLICATION INFORMATION

Current Regulation Ramp-Up and Ramp-Down

Both current regulation loops ramp up and down when transitioning from pre-charge to fast charge, and when going in and out of fault/suspend mode where the LDO needs to be turned hard on or off. Figure 5 demonstrates the typical stepping ramp.

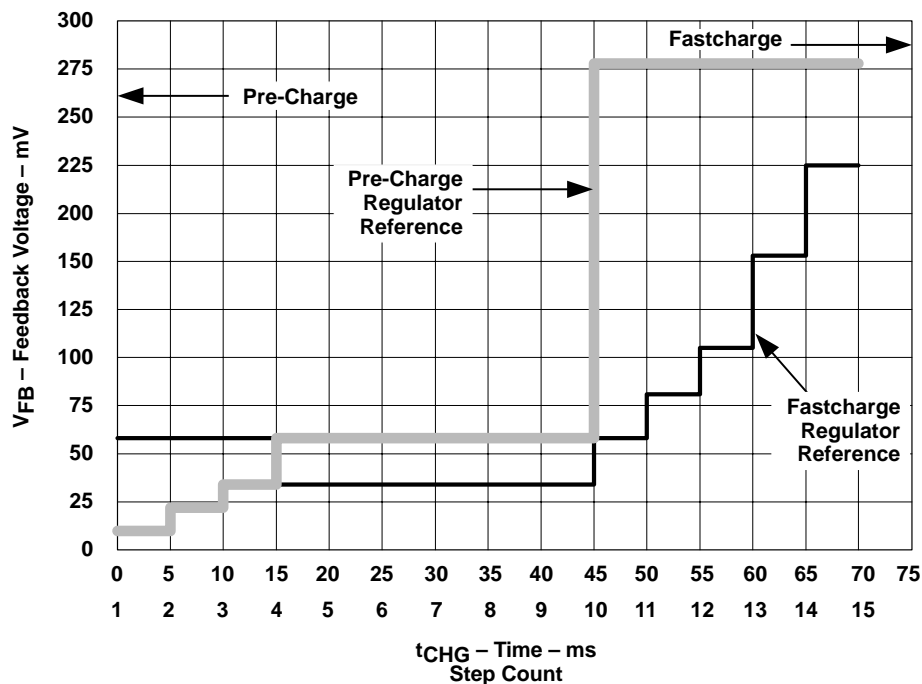

Figure 5. Typical Current Regulation Ramp From/To Pre-Charge/Fastcharge

APPLICATION INFORMATION

Battery Insertion and Removal Detection

The bq24901 reliably detects insertion and removal of battery packs under various conditions. This includes the battery packs with open or closed protectors. Figure 6 shows the flow chart. Table 1 provides a summary of various battery insertion and removal conditions.

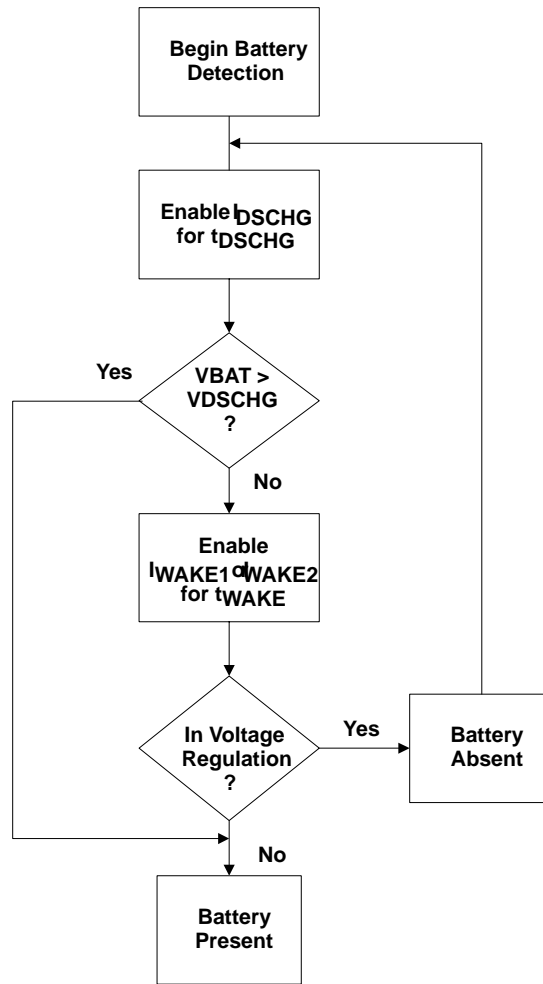

Figure 6. Battery Detection Summary

APPLICATION INFORMATION

Table 1. State Machine Status

STATE MACHINE STATUS		BATTERY PACK STATUS	ACTION
1	Following power-on reset (POR)	New pack insertion.	<ul style="list-style-type: none"> <input type="checkbox"/> The device remains in the battery presence detection loop until a new battery is detected. <input type="checkbox"/> Depending on the battery voltage, the device either enters pre-charge or fast charge.
2	Following POR	New deeply-discharged battery (with an open protector inserted).	<ul style="list-style-type: none"> <input type="checkbox"/> The device remains in the battery presence detection loop until a new battery is detected. <input type="checkbox"/> Depending on the battery voltage, the device either enters pre-charge or fast charge.
3	Pre-conditioning	Pack is removed.	<ul style="list-style-type: none"> <input type="checkbox"/> The device enters fast charge (since the output capacitor rises above V_{LOWV}) and terminates immediately due to I_{TERM} detection. <input type="checkbox"/> The device then enables I_{DISCHG} for $t_{DISCHG2}$. In the absence of a battery, the BAT voltage falls below V_{RCH}, prompting the device to indicate BATTERY ABSENT. If the battery is present the BAT voltage does not fall below V_{RCH} and therefore device assumes a battery is still connected and indicates DONE on STAT pins.
4	Fastcharge (current or voltage regulation)	Pack is removed.	<ul style="list-style-type: none"> <input type="checkbox"/> The device terminates immediately due to I_{TERM} detection. <input type="checkbox"/> The device then enables I_{DISCHG} for $t_{DISCHG2}$. In the absence of a battery, the BAT voltage falls below V_{RCH}, prompting the device to indicate BATTERY ABSENT. If the battery is present the BAT voltage does not fall below V_{RCH} and therefore device assumes a battery is still connected and indicates DONE on STAT pins.
5	Charge suspend	Pack is removed.	<ul style="list-style-type: none"> <input type="checkbox"/> The device remains the charge suspend mode as long as the TS pin voltage is outside the V_{LTF} to V_{HTF} range.
6	Charge suspend	Pack is removed. A new pack with normal temperature inserted.	<ul style="list-style-type: none"> <input type="checkbox"/> The device leaves the charge-suspend mode and resumes charging depending on the battery voltage. <input type="checkbox"/> The device resets the timers only if it enters a charge mode different from where the initial charge suspend condition happened (for instance from pre-charge to fast or vice versa)
7	Charge suspend	Pack is removed. A new pack with abnormal temperature inserted.	<ul style="list-style-type: none"> <input type="checkbox"/> The device remains the charge suspend mode as long as the TS pin voltage is outside the V_{LTF} to V_{HTF} range. <input type="checkbox"/> Once temperature returns to normal, item 6 in this table applies.
8	Charge suspend	Pack is removed. A pack with open protector and normal temperature inserted	<ul style="list-style-type: none"> <input type="checkbox"/> The device leaves the charge suspend mode. <input type="checkbox"/> The device enters pre-charge (since the voltage is below V_{LOWV}). This action closes the protector and charging resumes.
9	Charge suspend	Pack is removed. A pack with open protector and abnormal temperature inserted	<ul style="list-style-type: none"> <input type="checkbox"/> The device remains the charge suspend mode as long as the TS pin voltage is outside the V_{LTF} to V_{HTF} range. <input type="checkbox"/> Once temperature returns to normal, item 8 in this table applies.
10	Timer fault	Pack remains in charger.	<ul style="list-style-type: none"> <input type="checkbox"/> The device remains in the fault condition until POR or battery removal is detected.
11	Timer fault	Pack is removed.	<ul style="list-style-type: none"> <input type="checkbox"/> Once in the fault mode, the device applies the I_{DETECT} current to the output. The purpose of this current is to detect the removal of the pack. <input type="checkbox"/> If voltage regulation can be maintained with I_{DETECT} current, the device assumes the pack has been removed (and only output capacitor is present). <input type="checkbox"/> The device then awaits battery insertion as outlined item 1 of this table.
12	Timer fault	Pack is removed. A new pack is inserted.	<ul style="list-style-type: none"> <input type="checkbox"/> See item 11 in this table.
13	Timer fault	Pack is removed. A new pack with open protector is inserted.	<ul style="list-style-type: none"> <input type="checkbox"/> See items 11 and 12 in this table.
14	Timer fault	Pack remains in charger.	<ul style="list-style-type: none"> <input type="checkbox"/> The bq24901 in the Done state as long as the pack voltage is above the V_{RCH} threshold. While in the done state there is no current flow to the battery (zero current) <input type="checkbox"/> While in the DONE state, the device monitors the BAT voltage and initiates a new cycle once the BAT voltage falls below V_{RCH} threshold (this happens as the output capacitor discharges through the input leakage on the BAT pin).
15	Done	Pack is removed.	<ul style="list-style-type: none"> <input type="checkbox"/> While in the DONE state, the device monitors the BAT voltage and initiates a new cycle once the BAT voltage falls below V_{RCH} threshold (this happens as the output capacitor discharges through the input leakage on the BAT pin).

APPLICATION INFORMATION

Charge Termination and Re-Charge

The bq24901 monitors the charging current during voltage regulation. The device declares a DONE condition and terminates charge when then the current tapers off to charge termination current detect threshold. The charge termination level is set through TADJ pin as detailed in Table 2 and Figure 7.

Table 2. Charge Termination Adjustment

TADJ INPUT	TERMINATION LEVEL
Connected directly to VREF pin	$\frac{V_{SNS}}{10}$
Connected directly to VSS pin	$\frac{V_{SNS}}{20}$
Connected directly to the mid-point of a resistor divider between VREF and VSS pins (see Figure 8)	$\left(\frac{R2 \times V_{SNS}}{20 (R1 + R2)} \right) + \left(\frac{V_{SNS}}{20} \right)$

NOTE: V_{SNS} is the current regulation threshold.

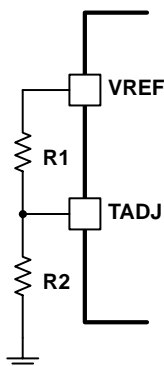

Figure 7. Charge Termination Adjustment Connection

The bq24901 also features two internal digital filters for detecting termination threshold. The digital filters, with $t_{TERMDET1}$ and $t_{TERMDET2}$ response times, are designed to reduce the possibility of early termination due to line or switching frequency noise.

A new charge cycle is initiated when one of the following conditions are detected:

1. Battery voltage falls below the V_{RCH} threshold
2. New battery insertion (once battery falls below the V_{RCH} threshold)
3. Power-on reset (POR)

APPLICATION INFORMATION

Charge Timers

The bq24901 provides two charge timers to protect the battery during pre-charge and charge phases. The first timer, T30min, is reset at the beginning of a new charge cycle and initiated in the pre-charge phase. During pre-charge, if the timer expires before the battery rises above the V_{LOWV} threshold, a fault condition is annunciated. Power-on reset or battery replacement clears the fault.

The second timer, T5hr, is reset at the beginning of a new charge cycle and is initiated at the beginning of the charge phase. A fault condition is annunciated if the battery current fails to reach charge termination current detect threshold, I_{TERM} , during charge. Power-on reset or battery replacement clears the fault.

Charge Status Display

The open-drain STAT1 and STAT2 outputs indicate various charger operations as shown in the Table 3.

Table 3. Charge Termination Adjustment

CHARGE STATE	STAT1	STAT2
Battery absent	OFF ⁽¹⁾	OFF
Charge-in-progress	ON	OFF
Charge done	OFF	ON
Charge suspend (temperature)	OFF	OFF
Timer fault	OFF	OFF

(1) OFF means the open-drain output transistor on the STATx pin is in an off state.

PACKAGING INFORMATION

Orderable Device	Status (1)	Package Type	Package Drawing	Pins	Package Qty	Eco Plan (2)	Lead/Ball Finish	MSL Peak Temp (3)	Op Temp (°C)	Top-Side Markings (4)	Samples
BQ24901PW	OBSOLETE	TSSOP	PW	14		TBD	Call TI	Call TI	-20 to 85	24901	
BQ24901PWG4	OBSOLETE	TSSOP	PW	14		TBD	Call TI	Call TI	-20 to 85	24901	

(1) The marketing status values are defined as follows:

ACTIVE: Product device recommended for new designs.

LIFEBUY: TI has announced that the device will be discontinued, and a lifetime-buy period is in effect.

NRND: Not recommended for new designs. Device is in production to support existing customers, but TI does not recommend using this part in a new design.

PREVIEW: Device has been announced but is not in production. Samples may or may not be available.

OBSOLETE: TI has discontinued the production of the device.

(2) Eco Plan - The planned eco-friendly classification: Pb-Free (RoHS), Pb-Free (RoHS Exempt), or Green (RoHS & no Sb/Br) - please check <http://www.ti.com/productcontent> for the latest availability information and additional product content details.

TBD: The Pb-Free/Green conversion plan has not been defined.

Pb-Free (RoHS): TI's terms "Lead-Free" or "Pb-Free" mean semiconductor products that are compatible with the current RoHS requirements for all 6 substances, including the requirement that lead not exceed 0.1% by weight in homogeneous materials. Where designed to be soldered at high temperatures, TI Pb-Free products are suitable for use in specified lead-free processes.

Pb-Free (RoHS Exempt): This component has a RoHS exemption for either 1) lead-based flip-chip solder bumps used between the die and package, or 2) lead-based die adhesive used between the die and leadframe. The component is otherwise considered Pb-Free (RoHS compatible) as defined above.

Green (RoHS & no Sb/Br): TI defines "Green" to mean Pb-Free (RoHS compatible), and free of Bromine (Br) and Antimony (Sb) based flame retardants (Br or Sb do not exceed 0.1% by weight in homogeneous material)

(3) MSL, Peak Temp. -- The Moisture Sensitivity Level rating according to the JEDEC industry standard classifications, and peak solder temperature.

(4) Only one of markings shown within the brackets will appear on the physical device.

Important Information and Disclaimer: The information provided on this page represents TI's knowledge and belief as of the date that it is provided. TI bases its knowledge and belief on information provided by third parties, and makes no representation or warranty as to the accuracy of such information. Efforts are underway to better integrate information from third parties. TI has taken and continues to take reasonable steps to provide representative and accurate information but may not have conducted destructive testing or chemical analysis on incoming materials and chemicals. TI and TI suppliers consider certain information to be proprietary, and thus CAS numbers and other limited information may not be available for release.

In no event shall TI's liability arising out of such information exceed the total purchase price of the TI part(s) at issue in this document sold by TI to Customer on an annual basis.

PW (R-PDSO-G14)

PLASTIC SMALL OUTLINE



4040064-3/G 02/11

- NOTES:
- A. All linear dimensions are in millimeters. Dimensioning and tolerancing per ASME Y14.5M-1994.
 - B. This drawing is subject to change without notice.
 -  C. Body length does not include mold flash, protrusions, or gate burrs. Mold flash, protrusions, or gate burrs shall not exceed 0,15 each side.
 -  D. Body width does not include interlead flash. Interlead flash shall not exceed 0,25 each side.
 - E. Falls within JEDEC MO-153

IMPORTANT NOTICE

Texas Instruments Incorporated and its subsidiaries (TI) reserve the right to make corrections, enhancements, improvements and other changes to its semiconductor products and services per JESD46, latest issue, and to discontinue any product or service per JESD48, latest issue. Buyers should obtain the latest relevant information before placing orders and should verify that such information is current and complete. All semiconductor products (also referred to herein as "components") are sold subject to TI's terms and conditions of sale supplied at the time of order acknowledgment.

TI warrants performance of its components to the specifications applicable at the time of sale, in accordance with the warranty in TI's terms and conditions of sale of semiconductor products. Testing and other quality control techniques are used to the extent TI deems necessary to support this warranty. Except where mandated by applicable law, testing of all parameters of each component is not necessarily performed.

TI assumes no liability for applications assistance or the design of Buyers' products. Buyers are responsible for their products and applications using TI components. To minimize the risks associated with Buyers' products and applications, Buyers should provide adequate design and operating safeguards.

TI does not warrant or represent that any license, either express or implied, is granted under any patent right, copyright, mask work right, or other intellectual property right relating to any combination, machine, or process in which TI components or services are used. Information published by TI regarding third-party products or services does not constitute a license to use such products or services or a warranty or endorsement thereof. Use of such information may require a license from a third party under the patents or other intellectual property of the third party, or a license from TI under the patents or other intellectual property of TI.

Reproduction of significant portions of TI information in TI data books or data sheets is permissible only if reproduction is without alteration and is accompanied by all associated warranties, conditions, limitations, and notices. TI is not responsible or liable for such altered documentation. Information of third parties may be subject to additional restrictions.

Resale of TI components or services with statements different from or beyond the parameters stated by TI for that component or service voids all express and any implied warranties for the associated TI component or service and is an unfair and deceptive business practice. TI is not responsible or liable for any such statements.

Buyer acknowledges and agrees that it is solely responsible for compliance with all legal, regulatory and safety-related requirements concerning its products, and any use of TI components in its applications, notwithstanding any applications-related information or support that may be provided by TI. Buyer represents and agrees that it has all the necessary expertise to create and implement safeguards which anticipate dangerous consequences of failures, monitor failures and their consequences, lessen the likelihood of failures that might cause harm and take appropriate remedial actions. Buyer will fully indemnify TI and its representatives against any damages arising out of the use of any TI components in safety-critical applications.

In some cases, TI components may be promoted specifically to facilitate safety-related applications. With such components, TI's goal is to help enable customers to design and create their own end-product solutions that meet applicable functional safety standards and requirements. Nonetheless, such components are subject to these terms.

No TI components are authorized for use in FDA Class III (or similar life-critical medical equipment) unless authorized officers of the parties have executed a special agreement specifically governing such use.

Only those TI components which TI has specifically designated as military grade or "enhanced plastic" are designed and intended for use in military/aerospace applications or environments. Buyer acknowledges and agrees that any military or aerospace use of TI components which have **not** been so designated is solely at the Buyer's risk, and that Buyer is solely responsible for compliance with all legal and regulatory requirements in connection with such use.

TI has specifically designated certain components as meeting ISO/TS16949 requirements, mainly for automotive use. In any case of use of non-designated products, TI will not be responsible for any failure to meet ISO/TS16949.

Products

Audio	www.ti.com/audio
Amplifiers	amplifier.ti.com
Data Converters	dataconverter.ti.com
DLP® Products	www.dlp.com
DSP	dsp.ti.com
Clocks and Timers	www.ti.com/clocks
Interface	interface.ti.com
Logic	logic.ti.com
Power Mgmt	power.ti.com
Microcontrollers	microcontroller.ti.com
RFID	www.ti-rfid.com
OMAP Applications Processors	www.ti.com/omap
Wireless Connectivity	www.ti.com/wirelessconnectivity

Applications

Automotive and Transportation	www.ti.com/automotive
Communications and Telecom	www.ti.com/communications
Computers and Peripherals	www.ti.com/computers
Consumer Electronics	www.ti.com/consumer-apps
Energy and Lighting	www.ti.com/energy
Industrial	www.ti.com/industrial
Medical	www.ti.com/medical
Security	www.ti.com/security
Space, Avionics and Defense	www.ti.com/space-avionics-defense
Video and Imaging	www.ti.com/video

TI E2E Community

e2e.ti.com