

4-channel BTL driver for CD players

BA6394FP

The BA6394FP is a 4-channel H-bridge BTL driver for CD players. The internal standard operational amplifier and 28-pin HSOP package make this IC suited to compact applications, while the 3V power supply is ideal for portable devices.

●Applications
CD players and CD-ROM drives

- Features
- 1) 4-channel BTL driver.
 - 2) HSOP 28-pin package for compact applications.
 - 3) Wide dynamic range.
 - 4) Internal thermal shutdown circuit.
 - 5) Gain is adjustable with a single attached resistor.
 - 6) Internal standard operational adjuster.

●Block diagram

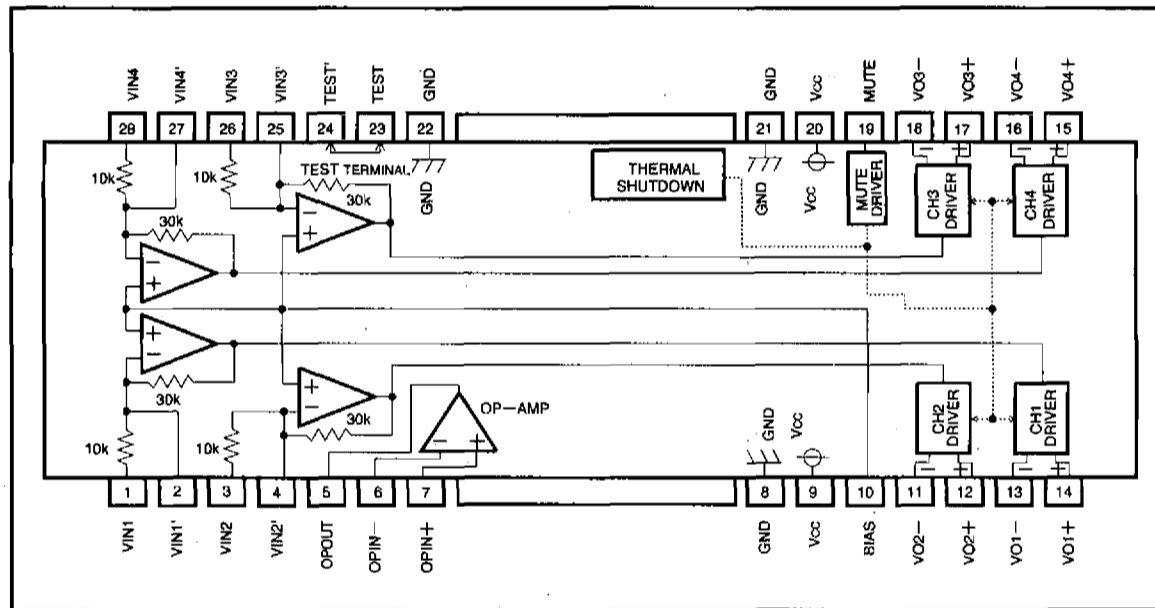

CD/CD-ROM Drivers (4 channels)
For CDs/CD-ROMs

●Pin description

Pin No.	Pin name	Description
1	VIN1	Driver CH1 input
2	VIN1'	Driver CH1 input, gain adjustment pin
3	VIN2	Driver CH2 input
4	VIN2'	Driver CH2 input, gain adjustment pin
5	OPOUT	Operational amplifier output
6	OPIN-	Operational amplifier input, negative
7	OPIN+	Operational amplifier input, positive
8	GND	Substrate ground
9	Vcc	Vcc
10	BIAS	Bias input
11	VO2-	Driver Ch2 negative output
12	VO2+	Driver Ch2 positive output
13	VO1-	Driver Ch1 negative output
14	VO1+	Driver Ch1 positive output
15	VO4+	Driver Ch4 positive output
16	VO4-	Driver Ch4 negative output
17	VO3+	Driver Ch3 positive output
18	VO3-	Driver Ch3 negative output
19	MUTE	Driver mute control input
20	Vcc	Vcc
21	GND	Substrate ground
22	GND	Regulator ground (internal constant current source GND)
23	TEST	TEST
24	TEST'	TEST
25	VIN3'	Driver CH3 input, gain adjustment pin
26	VIN3	Driver CH3 input
27	VIN4'	Driver CH4 input, gain adjustment pin
28	VIN4	Driver CH4 input

● Input/output circuit

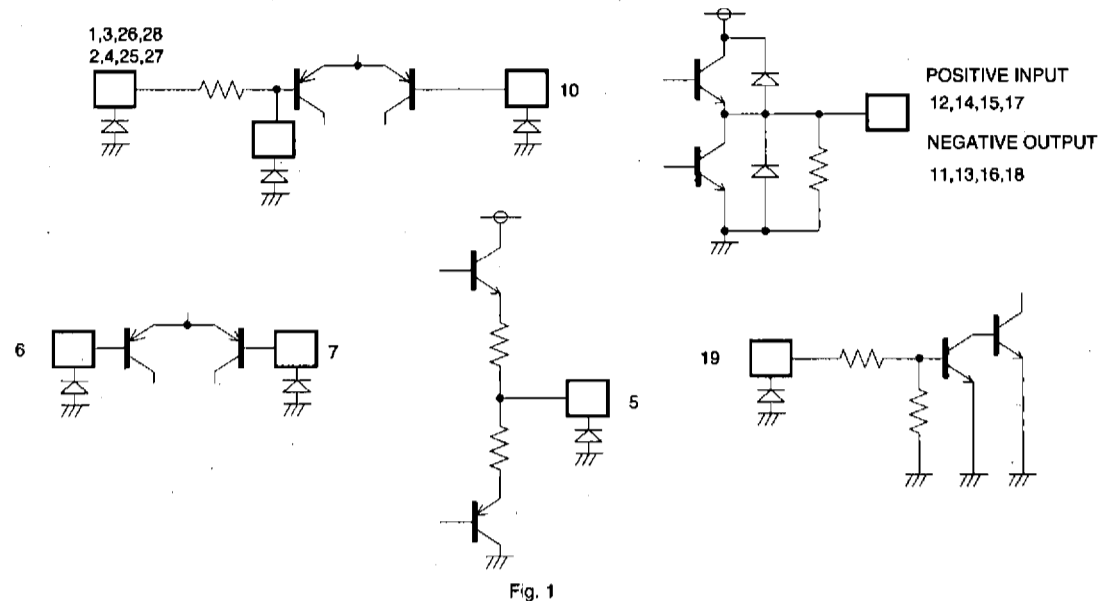

Fig. 1

● Absolute maximum ratings (Ta=25°C)

Parameter	Symbol	Limits	Unit
Power supply voltage	Vcc	18	V
Power dissipation	Pd	1.7*1	W
Operating temperature range	Topr	-25~85	°C
Storage temperature range	Tstg	-55~150	°C

* 1 When mounted to a 50 mm × 50 mm × 1.0 mm paper phenol board,
Reduced by 13.6 mW for each increase in Ta of 1°C over 25°C.

● Recommended operating conditions (Ta=25°C)

Parameter	Symbol	Limits	Unit
Power supply voltage range	Vcc	3~11	V

CD/CD-ROM Drivers (4 channels)

For CDs/CD-ROMs

●Electrical characteristics (Unless otherwise noted, Ta=25°C, Vcc=3.5V, RL=8Ω)

Parameter	Symbol	Min.	Typ.	Max.	Unit	Conditions
<Driver>						
Quiescent current	I _Q	2.35	4.7	7.0	mA	No load
Input voltage, offset	V _{OI}	-5	0	5	mV	
Output voltage, offset	V _{OO}	-5	0	5	mV	
Dead band width	V _{DB}	10	20	30	mV	(Total for positive and negative sides)
Maximum output amplitude	V _{OM}	1.7	1.9	—	V	Differential output
Voltage gain (closed circuit)	G _{VC}	6.0	8.0	10.5	dB	V _{in} =500mV DC,differential output
Gain, positive and negative voltage differential	ΔG _{VC}	-0.9	0	0.9	dB	V _{in} =500mV DC,differential output
Ripple rejection	RR	—	80	—	dB	V _{in} =0.1Vrms, 100Hz
MUTE-OFF voltage	V _{MOFF}	2.0	—	—	V	
MUTE-ON voltage	V _{MON}	—	—	0.5	V	
<OP - AMP>						
Offset voltage	V _{OPOP}	-5	0	5	mV	
Input bias current	I _{BOP}	—	—	300	nA	
High level output voltage	V _{OHP}	2.5	2.8	—	V	
Low level output voltage	V _{OLP}	—	—	1.1	V	
Output drive current (sink)	I _{SINK}	10	25	—	mA	50Ω ⊘V _{CC}
Output drive current (source)	I _{SOURCE}	10	25	—	mA	50Ω ⊘GND
Voltage gain (open circuit)	G _{VO}	—	72	—	dB	V _{in} =-75dBV, 1kHz
Slew rate	SR	—	0.8	—	V/μS	

●Circuit operation

1. Driver

Inputs to the IC are the focus tracking error signal from the servo preamplifier and the control signal from the motor. Input signals are normally biased at 1/2V_{CC}, and switch polarity depending on voltage size relative to the bias voltage. When polarity is switched, power

transistors Q1 and Q4 or Q2 and Q3 turn on. Power transistor Q1 or Q3, whichever is turned on, is driven by the full wave rectified signal and the level shifted signal, and supplies current to the load. When there is no input, both output pins are at the GND level.

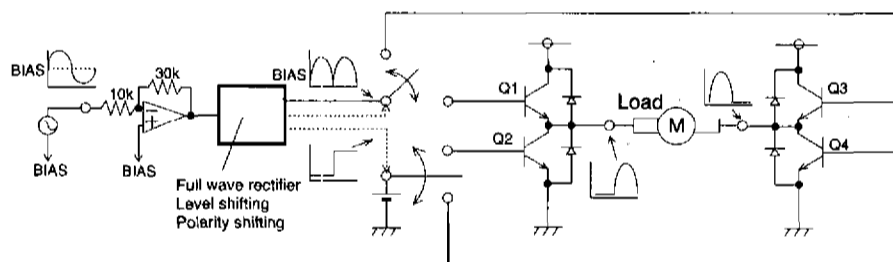

Fig. 2

2. Operational amplifier
A standard 4558 type.

●Application example

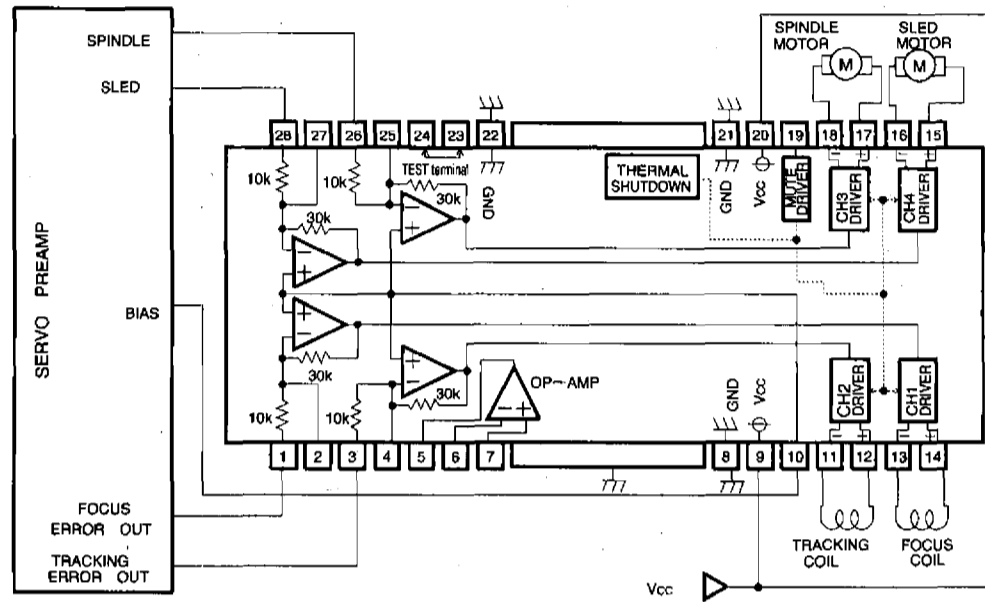

Fig. 3

●Operation notes

1. The BA6394FP has an internal thermal shutdown circuit. Output current is muted when the chip temperature exceeds 175°C (typically).
2. If the mute pin (19 pin) voltage is opened or lowered below 0.5V, the output current will be muted.
3. The bias pin (10 pin) is muted when lowered below 1.0V (typically). Make sure it stays above 1.2V during normal use.
4. Muting occurs during thermal shutdown, mute-on operations or a drop in the bias pin voltage or supply voltage. In each case, only the drivers are muted.
5. Dead zone width is determined as follows :
Dead zone width = input resistance (attached resistor + internal input resistor 1kΩ) × 1.0 μA . . . ①
When using the internal resistor (10kΩ), dead zone width is 10mV (typically one side). Because the input resistance and 1 μA temperature characteristics are canceled out, there is virtually no variation due to temperature as long as the internal input resistor is used. However, a dead zone like that defined by the above equation occurs when an external resistor is used to change gain. Temperature change is typically 4000ppm per degree.
6. Be sure to connect the IC to a 0.1 μF bypass capacitor to the power supply, at the base of the IC.
7. Because of the gain adjustment pin's high gain, connecting a long wire to it may result in output oscillation due to free capacitance. Use caution when designing wires.
8. Be sure to leave the test pins (23, 24 pin) open and unconnected.

CD/CD-ROM Drivers (4 channels)

For CDs/CD-ROMs

● Thermal derating curve

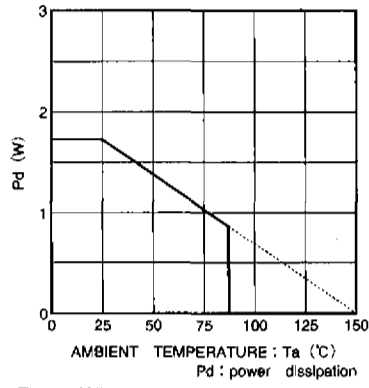

Fig. 4 When mounted to a 50X 50 X 1.0 (mm) paper phenol board

● Electrical characteristics curve

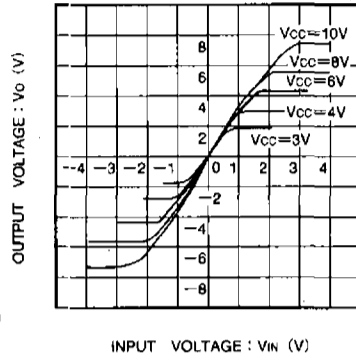

Fig. 5 Driver I/O characteristics (variable power supply)

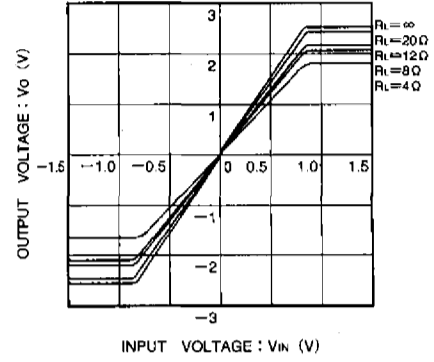

Fig. 6 Driver I/O characteristics (variable load)

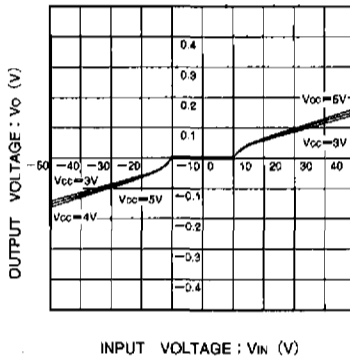

Fig. 7 Dead zone I/O characteristics

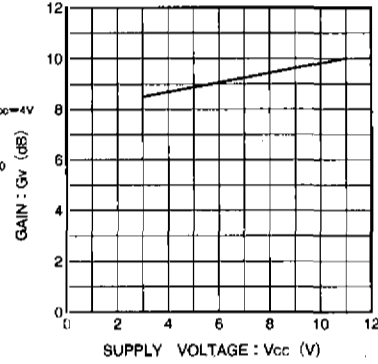

Fig. 8 Driver voltage gain vs. supply voltage

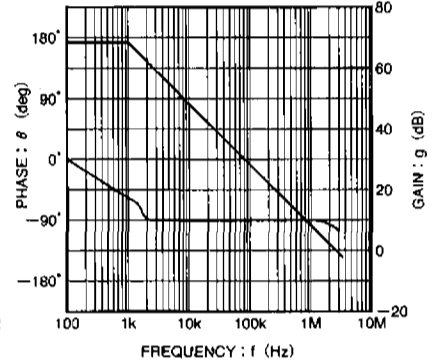
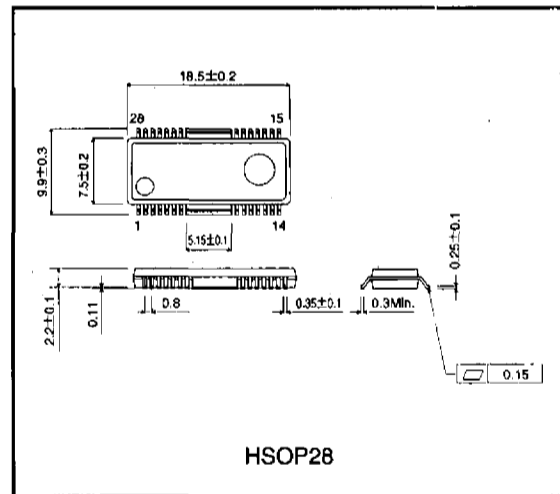

Fig. 9 Operational amplifier vs. open loop characteristics

● External dimensions (Units: mm)



Notes

- The contents described in this catalogue are correct as of March 1997.
- No unauthorized transmission or reproduction of this book, either in whole or in part, is permitted.
- The contents of this book are subject to change without notice. Always verify before use that the contents are the latest specifications. If, by any chance, a defect should arise in the equipment as a result of use without verification of the specifications, ROHM CO., LTD., can bear no responsibility whatsoever.
- Application circuit diagrams and circuit constants contained in this data book are shown as examples of standard use and operation. When designing for mass production, please pay careful attention to peripheral conditions.
- Any and all data, including, but not limited to application circuit diagrams, information, and various data, described in this catalogue are intended only as illustrations of such devices and not as the specifications for such devices. ROHM CO., LTD., disclaims any warranty that any use of such device shall be free from infringement of any third party's intellectual property rights or other proprietary rights, and further, assumes absolutely no liability in the event of any such infringement, or arising from or connected with or related to the use of such devices.
- Upon the sale of any such devices; other than for the buyer's right to use such devices itself, resell or otherwise dispose of the same; no express or implied right or license to practice or commercially exploit any intellectual property rights or other proprietary rights owned or controlled by ROHM CO., LTD., is granted to any such buyer.
- The products in this manual are manufactured with silicon as the main material.
- The products in this manual are not of radiation resistant design.

The products listed in this catalogue are designed to be used with ordinary electronic equipment or devices (such as audio-visual equipment, office-automation equipment, communications devices, electrical appliances, and electronic toys). Should you intend to use these products with equipment or devices which require an extremely high level of reliability and the malfunction of which would directly endanger human life (such as medical instruments, transportation equipment, aerospace machinery, nuclear-reactor controllers, fuel controllers, or other safety devices) please be sure to consult with our sales representatives in advance.

- Notes when exporting
 - It is essential to obtain export permission when exporting any of the above products when it falls under the category of strategic material (or labor) as determined by foreign exchange or foreign trade control laws.
 - Please be sure to consult with our sales representatives to ascertain whether any product is classified as a strategic material.