

# LED level meter driver, 5-point, VU scale

## BA6124 / BA6124F

The BA6124 and BA6124F are driver ICs for LED VU level meters in stereo equipment and other display applications.

The ICs display the input level (range :  $-10\text{dB}$  to  $+6\text{dB}$ ) on a 5-point, bar-type LED display.

The circuit includes a rectifier amplifier allowing direct AC input, and has constant-current outputs, so it can directly drive the LEDs without variations in LED current due to supply voltage fluctuations.

### ●Applications

VU meters, signal meters, and other display devices.

### ●Features

- 1) Rectifier amplifier allows either AC or DC input.
- 2) Constant-current outputs for constant LED current when the supply voltage fluctuates.
- 3) Built-in reference voltage means that power supply voltage fluctuations do not effect the display.
- 4) Wide operating voltage range (3.5V to 16V) for a wide range of applications.
- 5) Low PCB space requirements. Comes in a compact package and requires few external components.

### ●Block diagram

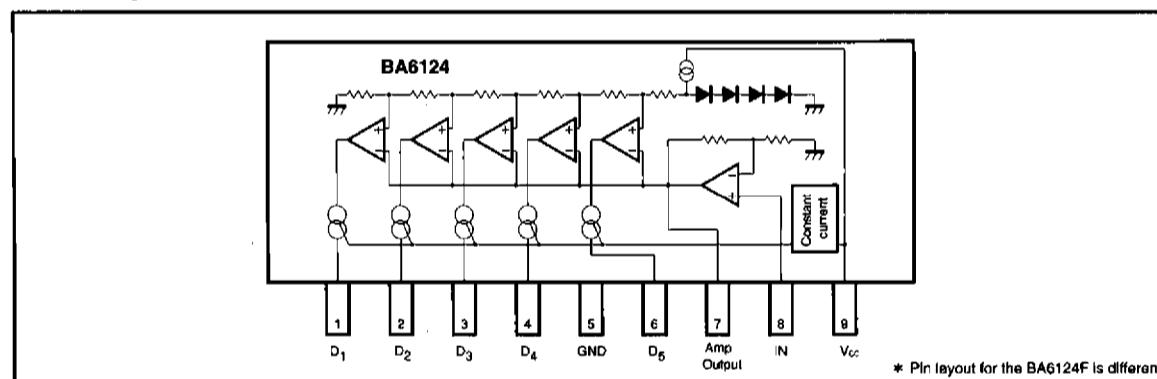

● Absolute maximum ratings (Ta = 25°C)

Parameter	Symbol	Limits	Unit
Supply voltage	V <sub>CC</sub>	18	V
Power dissipation	BA6124	500*1	mW
	BA6124F	300*2	
Operating temperature	T <sub>opr</sub>	-25~60	°C
Storage temperature	T <sub>stg</sub>	-55~125	°C
Junction temperature	T <sub>j</sub>	150	°C

\* 1 Reduced by 5mW for each increase in Ta of 1°C over 25°C.

\* 2 Reduced by 3mW for each increase in Ta of 1°C over 25°C.

● Electrical characteristics (unless otherwise specified Ta = 25°C, V<sub>CC</sub> = 6.0V, and f = 1kHz)

Parameter	Symbol	Min.	Typ.	Max.	Unit	Conditions	Measurement Circuit
Operating voltage range	V <sub>CC</sub>	3.5	6	16	V	—	Fig.1
Quiescent current	I <sub>Q</sub>	—	5	8	mA	V <sub>IN</sub> =0V	Fig.1
Control level 1	V <sub>C1</sub>	-11.5	-10	-8.5	dB	—	Fig.1
Control level 2	V <sub>C2</sub>	-6	-5	-4	dB	—	Fig.1
Control level 3	V <sub>C3</sub>	—	0	—	dB	Adjustment point	Fig.1
Control level 4	V <sub>C4</sub>	2.5	3	3.5	dB	—	Fig.1
Control level 5	V <sub>C5</sub>	5	6	7	dB	—	Fig.1
Sensitivity	V <sub>IN</sub>	74	85	96	mV <sub>rms</sub>	V <sub>C3</sub> on level	Fig.1
LED current	I <sub>LED</sub>	11	15	18.5	mA	—	Fig.1
Input bias current	I <sub>IN</sub>	—	0.3	1.0	μA	—	Fig.1

● Measurement circuit

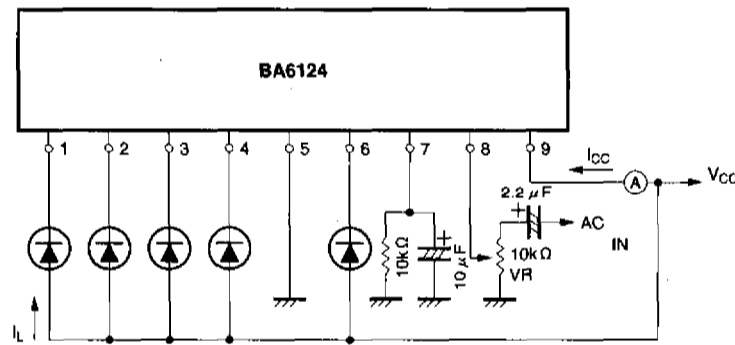

Fig. 1

Level meter drivers  
Audio accessory components

●Electrical characteristics curves (Ta = 25°C)

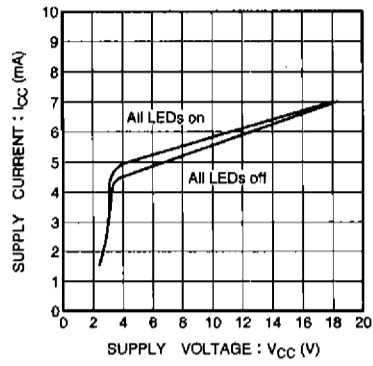

Fig. 2 Supply current vs. supply voltage

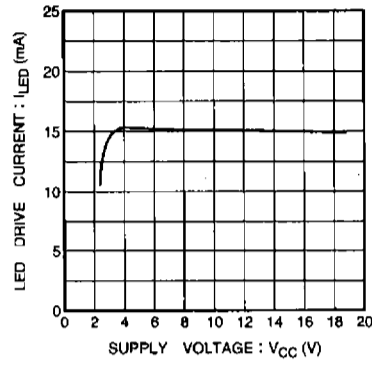

Fig. 3 LED drive current vs. supply voltage

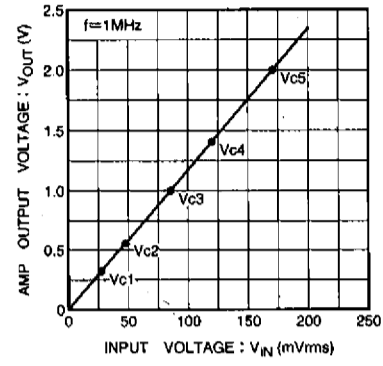

Fig. 4 Rectifier amplifier output voltage vs. input voltage

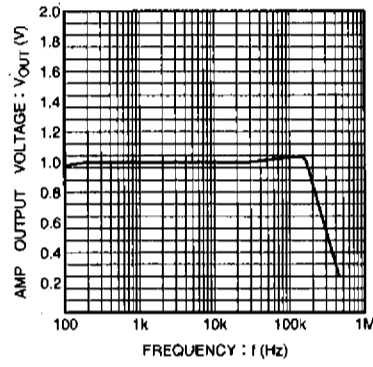

Fig. 5 Rectifier amplifier output voltage vs. frequency

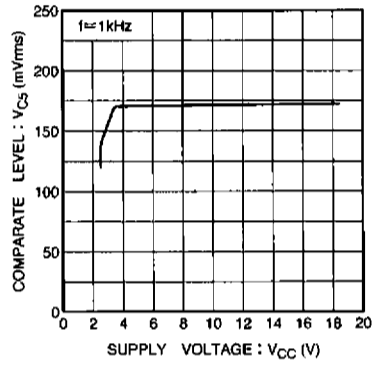

Fig. 6 Comparator level vs. supply voltage

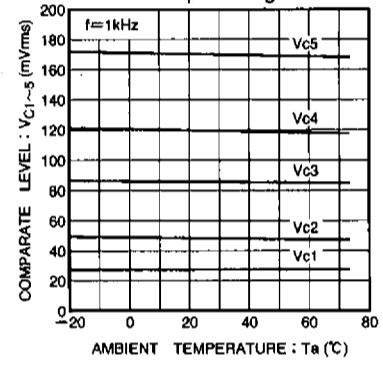

Fig. 7 Comparator level vs. ambient temperature

●Dimensions (Units: mm)

