Features

- Utilizes the ARM7TDMI™ ARM® Thumb® Processor Core
 - High-performance 32-bit RISC Architecture
 - High-density 16-bit Instruction Set
 - Embedded ICE (In-circuit Emulation)
- 128 Kbytes Internal RAM
- Fully Programmable External Bus Interface (EBI)
 - Maximum External Address Space of 64 Mbytes
 - Up to Four Chip Selects
 - Software Programmable 8-/16-bit External Data Bus
- 16-channel GPS Correlator
 - Accuracy: TBD
 - Time to First Fix: TBD
- 8-channel Peripheral Data Controller (PDC)
- 8-level Priority, Individually Maskable, Vectored Interrupt Controller
 - Three External Interrupts
- 20 Programmable I/O Lines
- Three USARTs
 - Two Dedicated Peripheral Data Controller (PDC) Channels per USART
- Master/Slave SPI Interface
 - Two Dedicated Peripheral Data Controller (PDC) Channels
 - 8- to 16-bit Programmable Data Length
 - Four External Slave Chip Selects
- Programmable Watchdog Timer
- Power Management Controller (PMC)
 - CPU and Peripherals Can Be Deactivated Individually
- Clock Manager (CLM)
 - Geared Master Clock to Reduce Power Consumption
 - Sleep State with Disabled Master Clock
- PWM Controller
 - Two PWM Signals
- Real Time Clock (RTC)
 - Time in GPS Format and 15-bit Fractional Part of a Second
 - Programmable Interrupt
 - Timer with a 8-bit Fractional Part of a Second and Parallel Load
- 2.3 V to 3.6 V or 1.8 V Supply Voltage
- Includes Power Supervisor
- Battery Backup Memory
- 9 mm × 9 mm 100-pin BGA Package

Description

The GPS baseband processor ATR0620 includes a 16-channel GPS correlator and is based on the ARM7TDMI processor core.

This processor has a high-performance 32-bit RISC architecture with a high-density 16-bit instruction set and very low power consumption. In addition, a large number of internally banked registers result in very fast exception handling, making the device ideal for real-time control applications.

The ATR0620 has a direct connection to off-chip memory, including flash, through the External Bus Interface (EBI).

The ATR0620 is manufactured using Atmel's high-density CMOS technology. By combining the ARM7TDMI microcontroller core with on-chip SRAM, 16-channel GPS correlator and a wide range of peripheral functions on a monolithic chip, the ATR0620 provides a highly flexible and cost-effective solution for GPS applications.



GPS Baseband Processor

ATR0620

Preliminary



Figure 1. Block Diagram

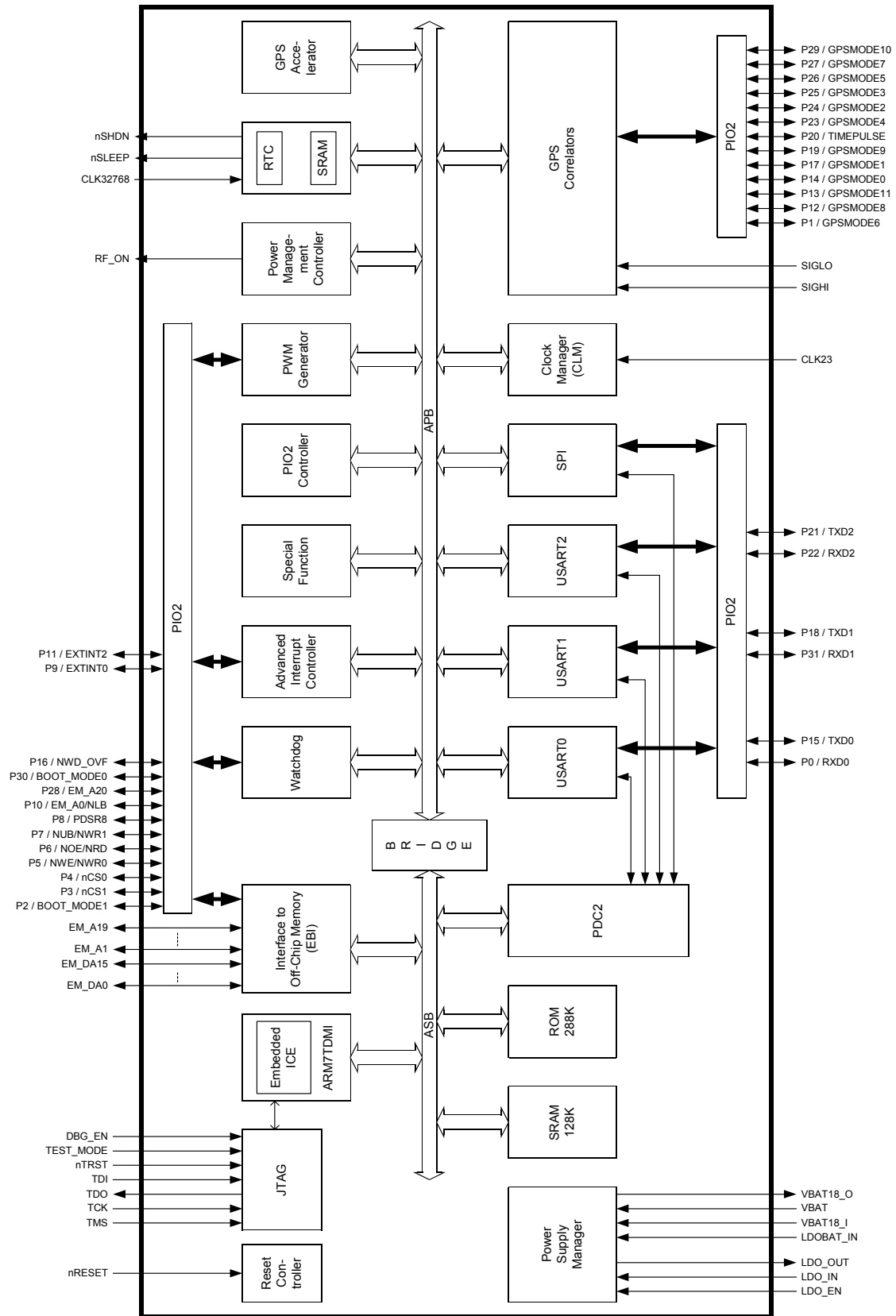

Pin Configuration

Serial Number	BGA 100	CPGA 144	Pin Name	Firmware Label	PIO Bank A		PIO Bank B	
					I	O	I	O
1	B6	C8	EM_DA0	(1)	(1)	(1)	(1)	(1)
2	B10	D13	EM_DA1	(1)	(1)	(1)	(1)	(1)
3	C7	B10	EM_DA2	(1)	(1)	(1)	(1)	(1)
4	C10	C15	EM_DA3	(1)	(1)	(1)	(1)	(1)
5	D10	F13	EM_DA4	(1)	(1)	(1)	(1)	(1)
6	E7	E15	EM_DA5	(1)	(1)	(1)	(1)	(1)
7	E9	F15	EM_DA6	(1)	(1)	(1)	(1)	(1)
8	B7	C9	EM_DA7	(1)	(1)	(1)	(1)	(1)
9	B8	B11	EM_DA8	(1)	(1)	(1)	(1)	(1)
10	A9	A14	EM_DA9	(1)	(1)	(1)	(1)	(1)
11	C8	B12	EM_DA10	(1)	(1)	(1)	(1)	(1)
12	B9	B13	EM_DA11	(1)	(1)	(1)	(1)	(1)
13	D8	E13	EM_DA12	(1)	(1)	(1)	(1)	(1)
14	C9	C14	EM_DA13	(1)	(1)	(1)	(1)	(1)
15	D9	D15	EM_DA14	(1)	(1)	(1)	(1)	(1)
16	E8	G14	EM_DA15	(1)	(1)	(1)	(1)	(1)
17	K5	N9	P15	TXD0	(1)	TXD0	(1)	MSOUT
18	K9	P14	P0	RXD0	RXD0	(1)	(1)	(1)
19	J5	Q10	P14	GPSMODE4	SCK0	SCK0	(1)	GPS_MON5
20	K4	Q7	P18	TXD1	(1)	TXD1	(1)	NUB/NWR1
21	H9	N15	P31	RXD1	RXD1	(1)	(1)	(1)
22	J4	P8	P17	GPSMODE5	SCK1	SCK1	(1)	GPS_MON6
23	F9	H14	SIGHI	(1)	(1)	(1)	(1)	(1)
24	E10	G13	SIGLO	(1)	(1)	(1)	(1)	(1)
25	J9	N14	XT_IN	(1)	(1)	(1)	(1)	(1)
26	J10	P15	XT_OUT	(1)	(1)	(1)	(1)	(1)
27	J6	Q11	nSLEEP	(1)	(1)	(1)	(1)	(1)
28	G9	J13	CLK23	(1)	(1)	(1)	(1)	(1)
29	G5	N8	P30	BOOT_MODE0	(1)	NWD_OVF	(1)	GPS_MON0
30	G4	P7	P2	BOOT_MODE1	(1)	1PPS	(1)	GPS_MON1
31	J1	P2	TMS	(1)	(1)	(1)	(1)	(1)
32	J3	P6	TCK	(1)	(1)	(1)	(1)	(1)
33	J2	P4	TDI	(1)	(1)	(1)	(1)	(1)
34	K2	Q3	nTRST	(1)	(1)	(1)	(1)	(1)
35	K3	N6	TDO	(1)	(1)	(1)	(1)	(1)
36	F4	N1	TEST_MODE	(1)	(1)	(1)	(1)	(1)
37	H4	N7	DBG_EN	(1)	(1)	(1)	(1)	(1)
38	K6	N10	RF_ON	(1)	(1)	(1)	(1)	(1)
39	C4	B3	nRESET	(1)	(1)	(1)	(1)	(1)
40	G7	L14	nSHDN	(1)	(1)	(1)	(1)	(1)
41	A6	B8	EM_A1	(1)	(1)	(1)	(1)	(1)
42	A5	A6	EM_A2	(1)	(1)	(1)	(1)	(1)
43	A4	A5	EM_A3	(1)	(1)	(1)	(1)	(1)
44	A2	C3	EM_A4	(1)	(1)	(1)	(1)	(1)

Note: 1. No selection option for PIO.





Pin Configuration (Continued)

Serial Number	BGA 100	CPGA 144	Pin Name	Firmware Label	PIO Bank A		PIO Bank B	
					I	O	I	O
45	A3	C5	EM_A5					
46	B5	B7	EM_A6	(1)	(1)	(1)	(1)	(1)
47	B4	A3	EM_A7	(1)	(1)	(1)	(1)	(1)
48	B2	B1	EM_A8	(1)	(1)	(1)	(1)	(1)
49	D4	F2	EM_A9	(1)	(1)	(1)	(1)	(1)
50	C2	F3	EM_A10	(1)	(1)	(1)	(1)	(1)
51	D6	A9	EM_A11	(1)	(1)	(1)	(1)	(1)
52	D7	C10	EM_A12	(1)	(1)	(1)	(1)	(1)
53	C3	C1	EM_A13	(1)	(1)	(1)	(1)	(1)
54	C1	E2	EM_A14	(1)	(1)	(1)	(1)	(1)
55	D5	A4	EM_A15	(1)	(1)	(1)	(1)	(1)
56	C6	C7	EM_A16	(1)	(1)	(1)	(1)	(1)
57	F8	H13	EM_A17	(1)	(1)	(1)	(1)	(1)
58	B3	C4	EM_A18	(1)	(1)	(1)	(1)	(1)
59	C5	C6	EM_A19	(1)	(1)	(1)	(1)	(1)
60	E5	Q1	VDD18_R	(1)	(1)	(1)	(1)	(1)
61	E6	A1	VDD18_B	(1)	(1)	(1)	(1)	(1)
62	F7	K15	VDD18_L2	(1)	(1)	(1)	(1)	(1)
63	F6	A15	VDD18_L1	(1)	(1)	(1)	(1)	(1)
64	J7	P13	VBAT	(1)	(1)	(1)	(1)	(1)
65	A1	D3	GND_R	(1)	(1)	(1)	(1)	(1)
66	A10	C12	GND_B	(1)	(1)	(1)	(1)	(1)
67	K1	N4	GND_T	(1)	(1)	(1)	(1)	(1)
68	F10	J15	GND_L	(1)	(1)	(1)	(1)	(1)
69	K10	M13	GND_BAT	(1)	(1)	(1)	(1)	(1)
70	H1	N2	P24	GPSMODE8	MOSI	MOSI	(1)	GPS_MON2
71	D1	G3	P25	GPSMODE9	MISO	MISO	(1)	GPS_MON3
72	H3	P5	P23	GPSMODE7	SCK	SCK	(1)	MCLK_OUT
73	G8	M15	P26	GPSMODE10	NSS	NPCSO	(1)	GPS_MON4
74	J8	N13	P9	GPSMODE1	EXTINT0	(1)	(1)	EM_A0/NLB
75	H7	N12	LDO_EN	(1)	(1)	(1)	(1)	(1)
76	H6	Q13	LDO_OUT	(1)	(1)	(1)	(1)	(1)
77	H5	P9	P3 (OH)	nCS1	(1)	nCS1	(1)	AGCOUT0
78	A7	B9	P4 (OH)	nCS0	(1)	nCS0	(1)	(1)
79	B1	D2	P5 (OH)	NWE/NWR0	(1)	NWE/NWR0	(1)	(1)
80	A8	A13	P6 (OH)	NOE/NRD	(1)	NOE/NRD	(1)	(1)
81	K7	P12	LDO_IN	(1)	(1)	(1)	(1)	(1)
82	D2	G1	P7 (OH)	NUB/NWR1	(1)	NUB/NWR1	(1)	(1)
83	E4	H2	P10 (OH)	EM_A0/NLB	(1)	EM_A0/NLB	(1)	MCLK_OUT
84	H10	L13	P11	EM_A21	EXTINT2	(1)	(1)	EM_A21
85	G2	L3	P8	OUT (RFU)	(1)	AGCOUT0	(1)	GPS_MON10
86	E1	H3	P16	NWD_OVF	SIGHI2	(1)	(1)	NWD_OVF
87	F1	J2	P19	GPSMODE6	SIGLO2	(1)	(1)	EM_A20
88	G3	M3	P1	GPSMODE0	(1)	AGCOUT1	(1)	GPS_MON7
89	K8	Q14	LDOBAT_IN	(1)	(1)	(1)	(1)	(1)

Note: 1. No selection option for PIO.

Pin Configuration (Continued)

Serial Number	BGA 100	CPGA 144	Pin Name	Firmware Label	PIO Bank A		PIO Bank B	
					I	O	I	O
90	F2	K3	P21	TXD2	(1)	TXD2	(1)	EM_A22
91	H8	M14	P22	RXD2	RXD2	(1)	(1)	EM_A23
92	H2	N3	P20	1PPS	SCK2	SCK2	(1)	1PPS
93	E2	J3	P27	GPSPMODE11	(1)	NPCS1	(1)	GPS_MON11
94	G1	M1	P28	EM_A20	(1)	NPCS2	(1)	EM_A20
95	E3	K1	P29	GPSPMODE12	(1)	NPCS3	(1)	MSOUT
96	F3	L1	P12	GPSPMODE2	(1)	nCS2	(1)	GPS_MON8
97	G10	K13	P13	GPSPMODE3	EXTINT1	nCS3	(1)	GPS_MON9
98	G6	N11	VBAT18_O	(1)	(1)	(1)	(1)	(1)
99	F5	Q15	VBAT18_I	(1)	(1)	(1)	(1)	(1)
100	D3	G2	TOUT1	(1)	APB_SELECT	(1)	(1)	(1)
101	(1)	C13	EM_DA16	(1)	(1)	(1)	(1)	(1)
102	(1)	E3	EM_DA17	(1)	(1)	(1)	(1)	(1)
103	(1)	D14	EM_DA18	(1)	(1)	(1)	(1)	(1)
104	(1)	E1	EM_DA19	(1)	(1)	(1)	(1)	(1)
105	(1)	F14	EM_DA20	(1)	(1)	(1)	(1)	(1)
106	(1)	H1	EM_DA21	(1)	(1)	(1)	(1)	(1)
107	(1)	H15	EM_DA22	(1)	(1)	(1)	(1)	(1)
108	(1)	K2	EM_DA23	(1)	(1)	(1)	(1)	(1)
109	(1)	J14	EM_DA24	(1)	(1)	(1)	(1)	(1)
110	(1)	M2	EM_DA25	(1)	(1)	(1)	(1)	(1)
111	(1)	P1	EM_DA26	(1)	(1)	(1)	(1)	(1)
112	(1)	Q2	EM_DA27	(1)	(1)	(1)	(1)	(1)
113	(1)	B2	EM_DA28	(1)	(1)	(1)	(1)	(1)
114	(1)	A2	EM_DA29	(1)	(1)	(1)	(1)	(1)
115	(1)	B4	EM_DA30	(1)	(1)	(1)	(1)	(1)
116	(1)	B5	EM_DA31	(1)	(1)	(1)	(1)	(1)
117	(1)	Q6	TMON0	(1)	(1)	(1)	(1)	(1)
118	(1)	Q8	TMON1	(1)	(1)	(1)	(1)	(1)
119	(1)	Q9	TMON2	(1)	(1)	(1)	(1)	(1)
120	(1)	P10	TMON3	(1)	(1)	(1)	(1)	(1)
121	(1)	P11	TMON4	(1)	(1)	(1)	(1)	(1)
122	(1)	Q12	TMON5	(1)	(1)	(1)	(1)	(1)
123	(1)	L15	TMON6	(1)	(1)	(1)	(1)	(1)
124	(1)	L2	TMON7	(1)	(1)	(1)	(1)	(1)
125	(1)	J1	TMON8	(1)	(1)	(1)	(1)	(1)
126	(1)	G15	TMON9	(1)	(1)	(1)	(1)	(1)
127	(1)	F1	TMON10	(1)	(1)	(1)	(1)	(1)
128	(1)	E14	TMON11	(1)	(1)	(1)	(1)	(1)
129	(1)	D1	TMON12	(1)	(1)	(1)	(1)	(1)
130	(1)	B15	TMON13	(1)	(1)	(1)	(1)	(1)
131	(1)	C2	TMON14	(1)	(1)	(1)	(1)	(1)
132	(1)	B14	TMON15	(1)	(1)	(1)	(1)	(1)
133	(1)	C11	TMON16	(1)	(1)	(1)	(1)	(1)
134	(1)	A12	TMON17	(1)	(1)	(1)	(1)	(1)

Note: 1. No selection option for PIO.



Pin Configuration (Continued)

Serial Number	BGA 100	CPGA 144	Pin Name	Firmware Label	PIO Bank A		PIO Bank B	
					I	O	I	O
135	(1)	A11	TMON18	(1)	(1)	(1)	(1)	
136	(1)	A10	TMON19	(1)	(1)	(1)	(1)	
137	(1)	A8	TMON20	(1)	(1)	(1)	(1)	
138	(1)	A7	TMON21	(1)	(1)	(1)	(1)	
139	(1)	B6	TMON22	(1)	(1)	(1)	(1)	
140	(1)	Q5	TMON23	(1)	(1)	(1)	(1)	
141	(1)	Q4	TMON24	(1)	(1)	(1)	(1)	
142	(1)	N5	TMON25	(1)	(1)	(1)	(1)	
143	(1)	P3	TMON26	(1)	(1)	(1)	(1)	
144	(1)	K14	POR_VEXT	(1)	(1)	(1)	(1)	

Note: 1. No selection option for PIO.

Pin Description

Module	Name	Function	Type	Active Level	Comment
EBI	EM_A0 – 23	Address bus	Output	–	All valid after reset
	EM_DA0 – 31	Data bus	I/O	–	–
	NCS0 – NCS3	Chip select	I/O	Low	–
	NWR0	Lower byte 0 write signal	I/O	Low	Used in byte write option
	NWR1	Lower byte 0 write signal	I/O	Low	Used in byte write option
	NRD	Read signal	I/O	Low	Used in byte write option
	NWE	Write enable	I/O	Low	Used in byte select option
	NOE	Output enable	I/O	Low	Used in byte select option
	NUB	Upper byte select (16-bit SRAM)	I/O	Low	Used in byte select option
	NLB	Lower byte select (16-bit SRAM)	Output	Low	Used in byte write option
	NWAIT	Wait signal	I/O	Low	–
	BOOT_MODE0	Boot mode input	I/O	–	PIO-controlled after reset, pull up
	BOOT_MODE1	Boot mode input	I/O	–	PIO-controlled after reset, pull down
USART	TXD0-2	Transmit data output	I/O	–	PIO-controlled after reset
	RXD0-2	Receive data input	I/O	–	PIO-controlled after reset
	SCK0-2	External serial clock	I/O	–	PIO-controlled after reset
AIC	EXTINT0-2	External interrupt request	I/O	High/Low	PIO-controlled after reset
PWM	AGCOUT0-1	Automatic gain control	Output	–	PIO-controlled after reset
PMC	RF_ON	–	–	–	ATR0600
RTC	nSleep	Clear sleep output (AF-LDO)	Output	Low	PIO-controlled after reset
	nSHDN	Clear sleep output (1.8LDO)	I/O	Low	PIO-controlled after reset
	XT_IN	Oscillator input	Input	–	OSC
	XT_OUT	Oscillator output	Output	–	OSC
SPI	SCK	SPI clock	I/O	–	PIO-controlled after reset
	MOSI	Master out slave in	I/O	–	PIO-controlled after reset
	MISO	Master in slave out	I/O	–	PIO-controlled after reset
	NPCS0-3	Slave select	I/O	Low	PIO-controlled after reset
WD	NWD_OVF	Watchdog timer overflow	I/O	–	PIO-controlled after reset

Pin Description (Continued)

Module	Name	Function	Type	Active Level	Comment
PIO	PDSR0-31	Programmable I/O port	I/O	–	Input after reset
GPS	GPSMODE0-12	GPS mode	I/O	–	PIO-controlled after reset
	SIGHI	–	Input	–	–
	SIGLO	–	Input	–	–
	SIGHI2	–	Input	–	–
	SIGLO2	–	Input	–	–
	1PPS	–	Output	–	–
	MSOUT	–	Output	–	–
	GPS_MON0-11	GPS monitor	I/O	–	–
JTAG/ ICE	TMS	Test mode select	Input	–	Pull down
	TDI	Test data in	Input	–	Pull down
	TDO	Test data out	Output	–	–
	TCK	Test clock	Input	–	Pull down
	NTRST	Test reset input	Input	Low	Pull down
	DBG_EN	Debug enable	Input	–	Pull down
CLOCK	CLK23	Clock input	Input	–	Schmitt trigger
	MCLK_OUT	Master clock output	Output	–	–
RESET	nReset	Reset input	Input	Low	–
POWER	VDD18	–	Power	–	–
	GND	–	Power	–	–
	VBAT18_I	–	IN Power	–	Backup power In
LDOBAT	LDOBAT_IN	–	Power	–	–
	VBAT	–	Power	–	–
	VBAT18_O	–	Out	–	Backup power out
LDO	LDO_IN	LDO in	Power	–	–
	LDO_OUT	LDO out	Power	–	–
	LDO_EN	LDO enable	Input	–	–
TEST	TEST_MODE	Test mode select	Input	–	Production test
	POR_VEXT	Test input	Input	–	For POR18 test
	TMON0-26	Test monitor output	Output	–	Debug package
	TOUT1/APB_Select	Test output	Output	–	–

Architecture Overview

The ATR0620 architecture consists of two main buses, the Advanced System Bus (ASB) and the Advanced Peripheral Bus (APB). The ASB is designed for maximum performance. It interfaces the processor with the on-chip 32-bit memories and the external memories and devices by means of the External Bus Interface (EBI). The APB is designed for accesses to on-chip peripherals and is optimized for low power consumption. The AMBA bridge provides an interface between the ASB and the APB.

An on-chip Peripheral Data Controller (PDC2) transfers data between the on-chip USARTs/SPI and the on- and off-chip memories without processor intervention. Most importantly, the PDC2 removes the processor interrupt handling overhead and significantly reduces the number of clock cycles required for a data transfer. It can transfer up to 64 K continuous bytes without reprogramming the starting address. As a result, the performance of the microcontroller is increased and the power consumption reduced.

The ATR0620 peripherals are designed to be easily programmable with a minimum number of instructions. Each peripheral has a 16-Kbyte address space allocated in the upper 3 M bytes of the 4-Gbyte address space. Except for the interrupt controller, the peripheral base address is the lowest address of its memory space. The peripheral register set is composed of control, mode, data, status and interrupt registers.

To maximize the efficiency of bit manipulation, frequently-written registers are mapped into three memory locations. The first address is used to set the individual register bits, the second resets the bits and the third address reads the value stored in the register. A bit can be set or reset by writing a one to the corresponding position at the appropriate address. Writing a zero has no effect. Individual bits can thus be modified without having to use costly read-modify-write and complex bit-manipulation instructions.

All of the external signals of the on-chip peripherals are under the control of the parallel I/O controller. The PIO2 controller can be programmed to insert an input filter on each pin or generate an interrupt on a signal change. After reset, the user must carefully program the PIO2 controller in order to define which peripheral signals are connected with off-chip logic.

The ARM7TDMI processor operates in little-endian mode in the ATR0620 GPS baseband. The processor's internal architecture and the ARM and Thumb instruction sets are described in the ARM7TDMI data sheet. The memory map and the on-chip peripherals are described in detail in the ATR0620 data sheet. The electrical and mechanical characteristics are also documented in the ATR0620 data sheet.

The ARM standard In-Circuit Emulation (ICE) debug interface is supported via the ICE port of the ATR0620.

PDC2

The ATR0620 has an 8-channel PDC2 dedicated to the three on-chip USARTs and to the SPI. One PDC2 channel is connected to the receiving channel and one to the transmitting channel of each peripheral.

The user interface of a PDC2 channel is integrated in the memory space of each USART channel and in the memory space of the SPI. It contains a 32-bit address pointer register and a 16-bit count register. When the programmed data is transferred, an end-of-transfer interrupt is generated by the corresponding peripheral. See the USART section and the SPI section for more details on PDC2 operation and programming.

EBI: External Bus Interface

The EBI generates the signals that control the access to the external memory or peripheral devices. The EBI is fully programmable and can address up to 64 bytes. It has four chip selects and a 20-bit address bus.

The 16-bit data bus can be configured to interface with 8- or 16-bit external devices. Separate read and write control signals allow for direct memory and peripheral interfacing. The EBI supports different access protocols, allowing single clock cycle memory accesses.

The main features are:

- External memory mapping
- 4 active low chip select lines
- 8- or 16-bit data bus
- Byte write or byte select lines
- User interface for remap function of boot memory
- Two different read protocols
- Programmable wait state generation
- Programmable data float time
- Programmable write protection for each memory bank

AIC: Advanced Interrupt Controller

The ATR0620 has an 8-level priority, individually maskable, vectored interrupt controller. This feature substantially reduces the software and real time overhead in handling internal and external interrupts.

The interrupt controller is connected to the NFIQ (fast interrupt request) and the NIRQ (standard interrupt request) inputs of the ARM7TDMI processor. The processor's NFIQ line can only be asserted by the external fast interrupt request input: FIQ. The NIRQ line can be asserted by the interrupts generated by the on-chip peripherals and the external interrupt request lines: IRQ0 to IRQ3.

An 8-level priority encoder allows the customer to define the priority between the different NIRQ interrupt sources. Internal sources are programmed to be level sensitive or edge triggered. External sources can be programmed to be positive or negative edge triggered or high- or low-level sensitive.

PIO2: Parallel I/O Controller

The ATR0620 features 32 programmable I/O lines. The I/O lines are multiplexed with on-chip peripheral I/O signals in order to optimize the use of available package pins. The PIO2 controller provides an internal interrupt signal to the Advanced Interrupt Controller (AIC).

USART2: Universal Synchronous/Asynchronous Receiver/Transmitter

The ATR0620 provides three identical, full-duplex, universal synchronous/asynchronous receiver/transmitters that interface to the APB and are connected to the peripheral data controller.

The main features are:

- Programmable baud rate generator
- Parity, framing and overrun error detection
- Line break generation and the detection
- Automatic echo, local loopback and remote loopback channel modes
- Multi-drop mode: address detection and generation
- Interrupt generation
- Two dedicated peripheral data controller channels
- 5-, 6-, 7-, 8-, and 9-bit character length
- Protocol ISO 7816 T = 0 and T = 1

SPI: Serial Peripheral Interface

The ATR0620 features an SPI, which provides communication with external devices in master or slave mode. The SPI has four external chip selects that can be connected to up to 15 devices. The data length is programmable from 8- to 16-bit. The PDC is used to move data directly between memory and SPI without CPU intervention for maximum real-time processing throughput.

WD: Watchdog Timer

The ATR0620 features an internal watchdog timer, which can be used to guard against system lock-up if the software becomes trapped in a deadlock. The watchdog timer can be programmed to generate an interrupt or an internal reset.

PMC: Power Manager Controller

The power management controller allows optimization of power consumption. The PMC enables/disables the clock inputs to most of the peripherals as well as to the ARM processor.

When the ARM clock is disabled, the current instruction is processed before the clock is stopped. The clock can be re-enabled by any enabled interrupt or by a hardware reset. When a peripheral clock is disabled, the clock is immediately stopped. When the clock is re-enabled the peripheral resumes action where it left off.

Due to the static nature of the design, the contents of the on-chip RAM and registers for which the clocks are disabled remain unchanged.

CLM: Clock Manager

In addition to the Power Management Controller (PMC) the Clock Manager (CLM) is another possibility to reduce power consumption. The clock manager provides fixed divided clocks for the USARTs, SPI and watchdog timer and generates the master clock which can be divided. The master clock is programmable for frequencies between 175 kHz and 23.1 MHz.

SF: Special Function

The ATR0620 provides registers that implement the following special functions:

- Chip identification
- RESET status

PWM

The PWM includes two PWM channels. They can be programmed separately. It is possible to generate an output voltage range from 0 to $(255/256) \times VDD18$.

RTC

The RTC provides the time in GPS format. The structure of the GPS system time: zero point is midnight Universal Time (UT) 5th/6th of January 1980. From the zero point weeks, time of week and the 15-bit fractional part of a second are counted. Each week has 604800 seconds (GPS system time does not count leap seconds. Therefore, compared to UT, the GPS time is shifted some seconds).

Additional the RTC provides a programmable interrupt (maximum period: one week).

GPS Correlator

The GPS correlator incorporates 16 GPS channels and provides all the functionality required for sampling, down-converting and correlating GPS signals.

The GPS correlator processes GPS signal data to acquire the GPS satellite signals using a model of the satellite codes and multiply/accumulate circuits (correlators) to spread the signal to a bandwidth low enough to detect it above thermal noise.

GPS Accelerator

The ATR0620 features an accelerator which reduces the time to identify the correct GPS signal.

Ordering Information

Extended Type Number	Package	Remarks
ATR0620-100	CTBGA100	9 mm × 9 mm, 0.80 mm pitch
ATR0620-144	PGA 144	Debug package

Package Outline CTBGA100

TOP VIEW

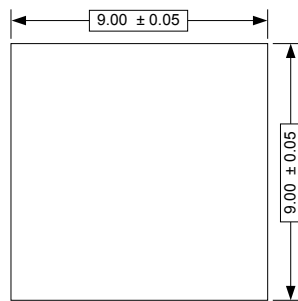

SIDE VIEW

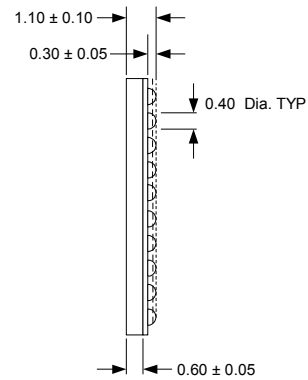

BOTTOM VIEW

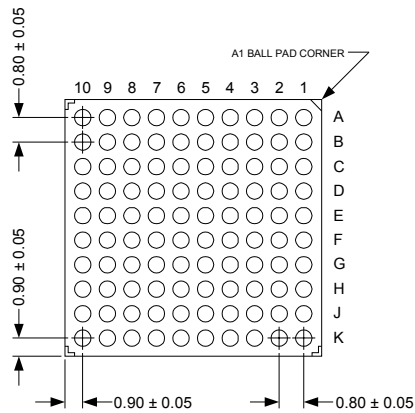

Package CPGA144

TOP VIEW

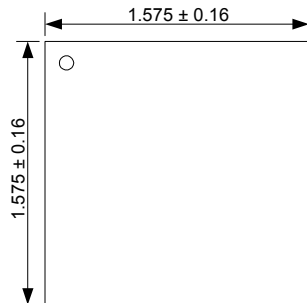

SIDE VIEW

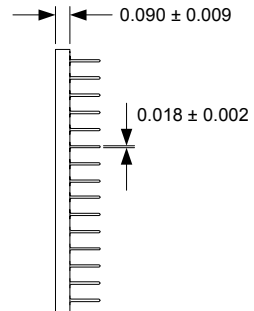

BOTTOM VIEW

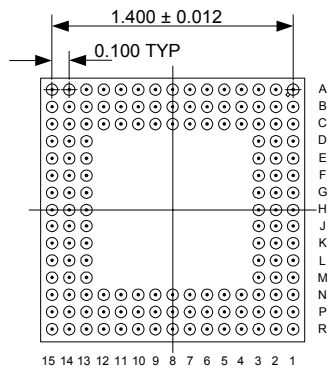



Atmel Headquarters

Corporate Headquarters

2325 Orchard Parkway
San Jose, CA 95131
TEL 1(408) 441-0311
FAX 1(408) 487-2600

Europe

Atmel Sarl
Route des Arsenaux 41
Case Postale 80
CH-1705 Fribourg
Switzerland
TEL (41) 26-426-5555
FAX (41) 26-426-5500

Asia

Room 1219
Chinachem Golden Plaza
77 Mody Road Tsimhatsui
East Kowloon
Hong Kong
TEL (852) 2721-9778
FAX (852) 2722-1369

Japan

9F, Tonetsu Shinkawa Bldg.
1-24-8 Shinkawa
Chuo-ku, Tokyo 104-0033
Japan
TEL (81) 3-3523-3551
FAX (81) 3-3523-7581

Atmel Operations

Memory

2325 Orchard Parkway
San Jose, CA 95131
TEL 1(408) 441-0311
FAX 1(408) 436-4314

Microcontrollers

2325 Orchard Parkway
San Jose, CA 95131
TEL 1(408) 441-0311
FAX 1(408) 436-4314

La Chantrerie
BP 70602
44306 Nantes Cedex 3, France
TEL (33) 2-40-18-18-18
FAX (33) 2-40-18-19-60

ASIC/ASSP/Smart Cards

Zone Industrielle
13106 Rousset Cedex, France
TEL (33) 4-42-53-60-00
FAX (33) 4-42-53-60-01

1150 East Cheyenne Mtn. Blvd.
Colorado Springs, CO 80906
TEL 1(719) 576-3300
FAX 1(719) 540-1759

Scottish Enterprise Technology Park
Maxwell Building
East Kilbride G75 0QR, Scotland
TEL (44) 1355-803-000
FAX (44) 1355-242-743

RF/Automotive

Theresienstrasse 2
Postfach 3535
74025 Heilbronn, Germany
TEL (49) 71-31-67-0
FAX (49) 71-31-67-2340

1150 East Cheyenne Mtn. Blvd.
Colorado Springs, CO 80906
TEL 1(719) 576-3300
FAX 1(719) 540-1759

Biometrics/Imaging/Hi-Rel MPU/ High Speed Converters/RF Datacom

Avenue de Rochepleine
BP 123
38521 Saint-Egreve Cedex, France
TEL (33) 4-76-58-30-00
FAX (33) 4-76-58-34-80

e-mail

literature@atmel.com

Web Site

<http://www.atmel.com>

© Atmel Corporation 2002.

Atmel Corporation makes no warranty for the use of its products, other than those expressly contained in the Company's standard warranty which is detailed in Atmel's Terms and Conditions located on the Company's web site. The Company assumes no responsibility for any errors which may appear in this document, reserves the right to change devices or specifications detailed herein at any time without notice, and does not make any commitment to update the information contained herein. No licenses to patents or other intellectual property of Atmel are granted by the Company in connection with the sale of Atmel products, expressly or by implication. Atmel's products are not authorized for use as critical components in life support devices or systems.

Atmel® is the registered trademark of Atmel.

ARM7TDMI™, ARM® and Thumb® are registered trademarks of ARM Limited.

Other terms and product names may be the trademarks of others.



Printed on recycled paper.