

ASM3P2107A

Product Preview

Peak EMI Reducing Solution

Description

The ASM3P2107A is a versatile spread spectrum frequency modulator designed specifically for input clock frequencies from 12 MHz to 22 MHz. The ASM3P2107A can generate an EMI reduced clock from crystal, ceramic resonator, or system clock.

The ASM3P2107A reduces electromagnetic interference (EMI) at the clock source, allowing system wide reduction of EMI of down stream clock and data dependent signals. The ASM3P2107A allows significant system cost savings by reducing the number of circuit board layers ferrite beads, shielding and other passive components that are traditionally required to pass EMI regulations.

The ASM3P2107A uses the most efficient and optimized modulation profile approved by the FCC and is implemented in a proprietary all digital method.

The ASM3P2107A modulates the output of a single PLL in order to “spread” the bandwidth of a synthesized clock, and more importantly, decreases the peak amplitudes of its harmonics. This results in significantly lower system EMI compared to the typical narrow band signal produced by oscillators and most frequency generators. Lowering EMI by increasing a signal’s bandwidth is called ‘spread spectrum clock generation.’

Applications

The ASM3P2107A is targeted towards EMI management for high speed digital applications such as PC peripheral devices, consumer electronics and embedded controller systems.

Features

- FCC Approved Method of EMI Attenuation
- Generates a 1X Low EMI Spread Spectrum Clock of the Input Frequency
- Input Frequency Range: 12 MHz to 22 MHz
- Internal Loop Filter Minimizes External Components and Board Space
- Frequency Deviation: – 0.8% (Typ) @ 20 MHz
- Low Cycle-to-Cycle Jitter
- 5.0 V ± 5% Operating Voltage Range
- TTL or CMOS Compatible Outputs
- Available in 8-pin TSSOP and SOIC Package
- These are Pb-Free Devices

This document contains information on a product under development. ON Semiconductor reserves the right to change or discontinue this product without notice.



ON Semiconductor®

<http://onsemi.com>



SOIC-8
S SUFFIX
CASE 751BD



TSSOP-8
T SUFFIX
CASE 948AL

PIN CONFIGURATION

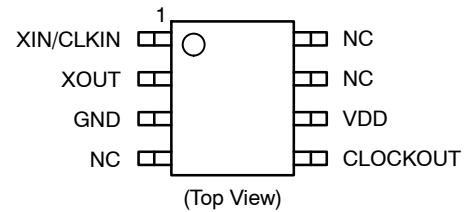

ORDERING INFORMATION

See detailed ordering and shipping information in the package dimensions section on page 6 of this data sheet.

ASM3P2107A

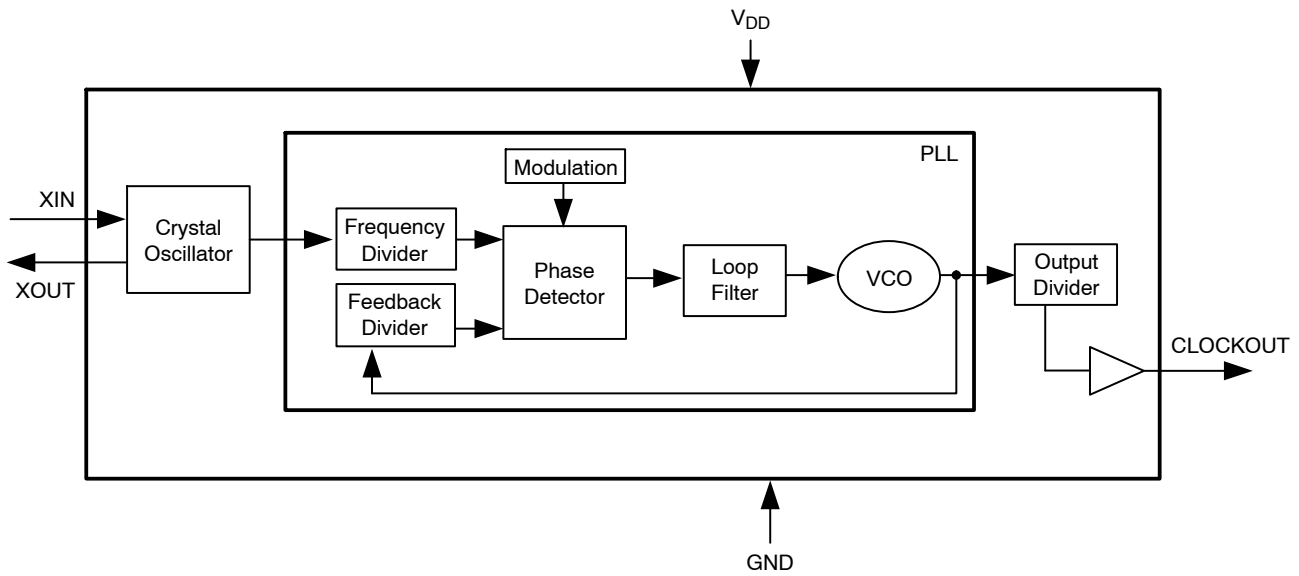

Figure 1. Block Diagram

Table 1. PIN DESCRIPTION

Pin #	Pin Name	Type	Description
1	XIN / CLKIN	I	Crystal connection or external reference frequency input. This pin has dual functions. It can be connected to either an external crystal or an external reference clock.
2	XOUT	O	Crystal connection. If using an external reference, this pin must be left unconnected.
3	GND	P	Ground to entire chip.
4	NC	-	No connect.
5	CLOCKOUT	O	Spread spectrum low EMI output.
6	VDD	P	Power supply for the entire chip (5 V).
7	NC	-	No connect.
8	NC	-	No connect.

Table 2. ABSOLUTE MAXIMUM RATINGS

Symbol	Parameter	Rating	Unit
V_{DD}, V_{IN}	Voltage on any pin with respect to Ground	-0.5 to +7.0	V
T_{STG}	Storage temperature	-65 to +125	°C
T_A	Operating temperature	0 to 70	°C
T_s	Max. Soldering Temperature (10 sec)	260	°C
T_J	Junction Temperature	150	°C
T_{DV}	Static Discharge Voltage (As per JEDEC STD22- A114-B)	2	KV

Stresses exceeding Maximum Ratings may damage the device. Maximum Ratings are stress ratings only. Functional operation above the Recommended Operating Conditions is not implied. Extended exposure to stresses above the Recommended Operating Conditions may affect device reliability.

ASM3P2107A

Table 3. DC ELECTRICAL CHARACTERISTICS

Symbol	Parameter	Min	Typ	Max	Unit
V _{IL}	Input low voltage	GND – 0.3	–	0.8	V
V _{IH}	Input high voltage	2.0	–	V _{DD} + 0.3	V
I _{IL}	Input low current	–	44	–	μA
I _{IH}	Input high current	–	66	–	μA
I _{XOL}	X _{OUT} output low current (@ 0.4, V _{DD} = 5 V)	–	3	–	mA
I _{XOH}	X _{OUT} output high current (@ 2.5 V, V _{DD} = 5 V)	–	3	–	mA
V _{OL}	Output low voltage (V _{DD} = 5 V, I _{OL} = 20 mA)	–	–	0.4	V
V _{OH}	Output high voltage (V _{DD} = 5 V, I _{OH} = 20 mA)	2.5	–	–	V
I _{CC}	Dynamic supply current normal mode (5 V, 18 MHz and 15 pF loading)	–	40	–	mA
I _{DD}	Static supply current standby mode	–	40	–	μA
V _{DD}	Operating voltage	4.75	5.0	5.25	V
t _{ON}	Power up time (first locked clock cycle after power up)	–	0.18	–	mS
Z _{OUT}	Clock out impedance	–	50	–	Ω

Table 4. AC ELECTRICAL CHARACTERISTICS

Symbol	Parameter	Min	Typ	Max	Unit	
f _{IN}	Input frequency	12	–	22	MHz	
MODOUT	Output frequency	12	–	22	MHz	
f _d	Frequency Deviation	Input Frequency = 12 MHz	–	–2.13	–	%
		Input Frequency = 22 MHz	–	–0.62	–	
t _{LH} (Note 1)	Output rise time (measured at 0.8 V to 2.0 V)	–	440	–	pS	
t _{HL} (Note 1)	Output fall time (measured at 2.0 V to 0.8 V)	–	300	–	pS	
t _{JC}	Jitter (cycle to cycle)	–	–	360	pS	
t _D	Output duty cycle	45	50	55	%	

1. V_{DD} = +5 V, Input Frequency = 18 MHz, t_{LH} and t_{HL} are measured into a capacitive load of 15 pF

ASM3P2107A

PACKAGE DIMENSIONS

TSSOP8, 4.4x3
CASE 948AL-01
ISSUE O

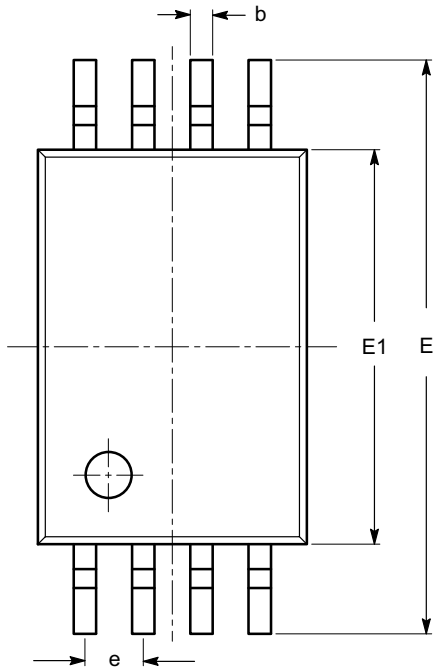

SYMBOL	MIN	NOM	MAX
A			1.20
A1	0.05		0.15
A2	0.80	0.90	1.05
b	0.19		0.30
c	0.09		0.20
D	2.90	3.00	3.10
E	6.30	6.40	6.50
E1	4.30	4.40	4.50
e	0.65 BSC		
L	1.00 REF		
L1	0.50	0.60	0.75
θ	0°		8°

TOP VIEW

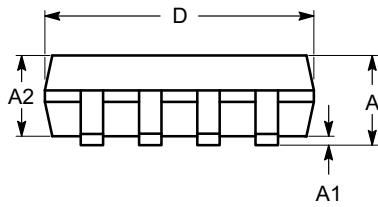

SIDE VIEW

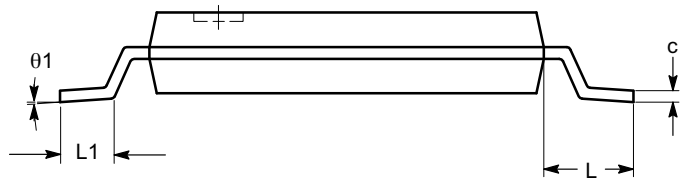

END VIEW

Notes:

- (1) All dimensions are in millimeters. Angles in degrees.
- (2) Complies with JEDEC MO-153.

ASM3P2107A

PACKAGE DIMENSIONS

SOIC 8, 150 mils
CASE 751BD-01
ISSUE O

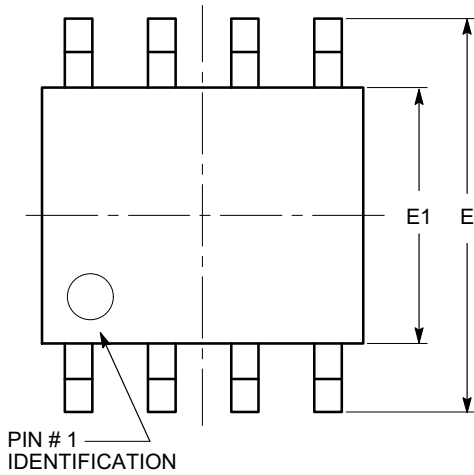

TOP VIEW

SYMBOL	MIN	NOM	MAX
A	1.35		1.75
A1	0.10		0.25
b	0.33		0.51
c	0.19		0.25
D	4.80		5.00
E	5.80		6.20
E1	3.80		4.00
e	1.27 BSC		
h	0.25		0.50
L	0.40		1.27
θ	0°		8°

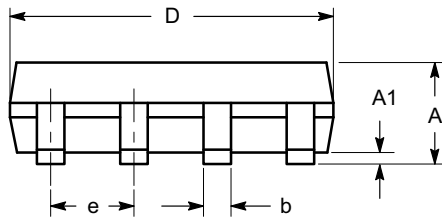

SIDE VIEW

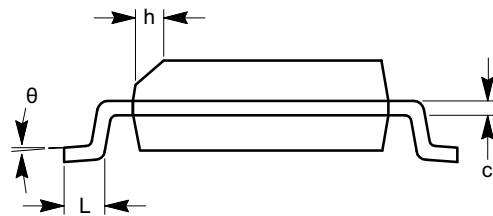

END VIEW

Notes:

- (1) All dimensions are in millimeters. Angles in degrees.
- (2) Complies with JEDEC MS-012.

ASM3P2107A

Table 5. ORDERING INFORMATION

Part Number	Marking	Package Type	Temperature
ASM3P2107AF-08-SR	3P2107AF	8-PIN SOIC, TAPE AND REEL, Pb Free	Commercial
ASM3P2107AF-08-ST	3P2107AF	8-PIN SOIC, TUBE, Pb Free	Commercial
ASM3P2107AF-08-TR	3P2107AF	8-PIN TSSOP, TAPE AND REEL, Pb Free	Commercial
ASM3P2107AF-08-TT	3P2107AF	8-PIN TSSOP, TUBE, Pb Free	Commercial
ASM3P2107AG-08-SR	3P2107AG	8-PIN SOIC, TAPE AND REEL, Green	Commercial
ASM3P2107AG-08-ST	3P2107AG	8-PIN SOIC, TUBE, Green	Commercial
ASM3P2107AG-08-TR	3P2107AG	8-PIN TSSOP, TAPE AND REEL, Green	Commercial
ASM3P2107AG-08-TT	3P2107AG	8-PIN TSSOP, TUBE, Green	Commercial

ON Semiconductor and  are registered trademarks of Semiconductor Components Industries, LLC (SCILLC). SCILLC reserves the right to make changes without further notice to any products herein. SCILLC makes no warranty, representation or guarantee regarding the suitability of its products for any particular purpose, nor does SCILLC assume any liability arising out of the application or use of any product or circuit, and specifically disclaims any and all liability, including without limitation special, consequential or incidental damages. "Typical" parameters which may be provided in SCILLC data sheets and/or specifications can and do vary in different applications and actual performance may vary over time. All operating parameters, including "Typicals" must be validated for each customer application by customer's technical experts. SCILLC does not convey any license under its patent rights nor the rights of others. SCILLC products are not designed, intended, or authorized for use as components in systems intended for surgical implant into the body, or other applications intended to support or sustain life, or for any other application in which the failure of the SCILLC product could create a situation where personal injury or death may occur. Should Buyer purchase or use SCILLC products for any such unintended or unauthorized application, Buyer shall indemnify and hold SCILLC and its officers, employees, subsidiaries, affiliates, and distributors harmless against all claims, costs, damages, and expenses, and reasonable attorney fees arising out of, directly or indirectly, any claim of personal injury or death associated with such unintended or unauthorized use, even if such claim alleges that SCILLC was negligent regarding the design or manufacture of the part. SCILLC is an Equal Opportunity/Affirmative Action Employer. This literature is subject to all applicable copyright laws and is not for resale in any manner.

PUBLICATION ORDERING INFORMATION

LITERATURE FULFILLMENT:

Literature Distribution Center for ON Semiconductor
P.O. Box 5163, Denver, Colorado 80217 USA
Phone: 303-675-2175 or 800-344-3860 Toll Free USA/Canada
Fax: 303-675-2176 or 800-344-3867 Toll Free USA/Canada
Email: orderlit@onsemi.com

N. American Technical Support: 800-282-9855 Toll Free
USA/Canada
Europe, Middle East and Africa Technical Support:
Phone: 421 33 790 2910
Japan Customer Focus Center
Phone: 81-3-5773-3850

ON Semiconductor Website: www.onsemi.com

Order Literature: <http://www.onsemi.com/orderlit>

For additional information, please contact your local Sales Representative