

AN5274

4.0 W × 2 (18 V, 8 Ω) Power Amplifier with Mute Function and Volume Control

■ Overview

The AN5274 is a monolithic integrated circuit designed for 4.0 W (18 V, 8 Ω) output audio power amplifier. It is a dual channel SEPP IC suitable for stereo operation in TV application.

■ Features

- Built-in DC volume control
- Built-in mute circuit
- Built-in thermal protection circuit
- Built-in over current protection circuit
- Higher ripple rejection as compared to AN5273
- V_{CC} operating range : 14.2 V to 27.5 V

■ Applications

- TV

■ Block Diagram

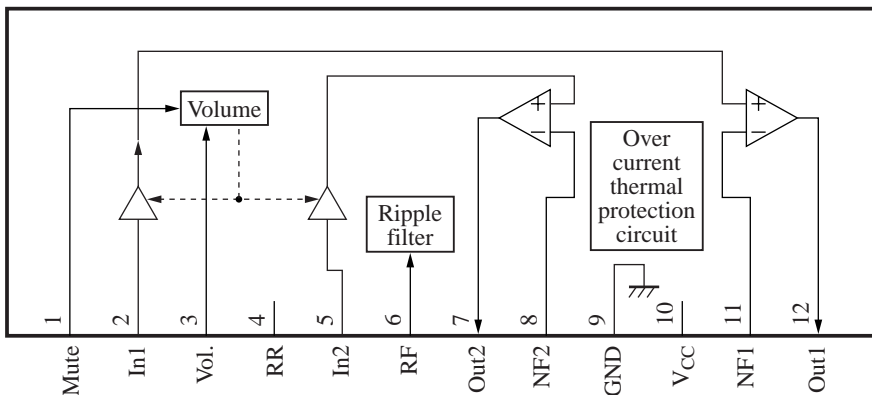

■ Pin Descriptions

Pin No.	Description	Pin No.	Description
1	Mute control	7	Ch.2 output
2	Ch.1 input	8	Negative feedback ch.2
3	Volume control	9	GND
4	Ripple rejection	10	V_{CC}
5	Ch.2 input	11	Negative feedback ch.1
6	Ripple filter	12	Ch.1 output

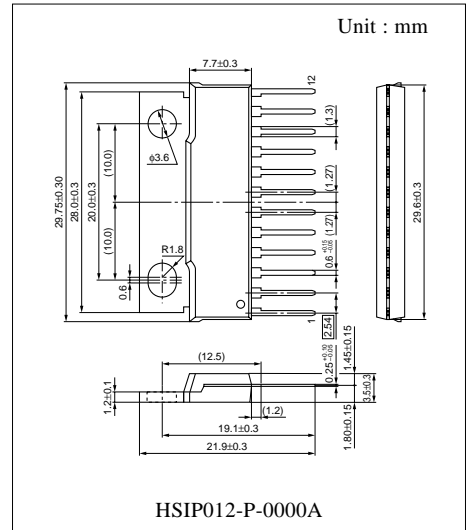

■ Absolute Maximum Ratings

Parameter	Symbol	Rating	Unit
Supply voltage	V_{CC}	29	V
Supply current	I_{CC}	3.5	A
Power dissipation *2	P_D	37.5	W
Operating ambient temperature *1	T_{opr}	-25 to +75	°C
Storage temperature *1	T_{stg}	-55 to +150	°C

Note) *1 : $T_a = 25\text{ °C}$ except power dissipation, operating ambient temperature and storage temperature.

*2 : Power dissipation of the package at $T_a = 75\text{ °C}$.

■ Recommended Operating Range

Parameter	Symbol	Range	Unit
Supply voltage	V_{CC}	14.2 to 27.5	V

■ Electrical Characteristics at $V_{CC} = 18\text{ V}$, $f = 1\text{ kHz}$, $R_L = 8\ \Omega$, $T_a = 25\text{ °C}$

Parameter	Symbol	Conditions	Min	Typ	Max	Unit
Quiescent current	I_{CQ}	No input signal	17	25	33	mA
Voltage gain	G_V	$V_{IN} = 90\text{ mV}$	28	30	32	dB
Total harmonic distortion *1	THD	$V_{IN} = 90\text{ mV}$	—	0.3	1.0	%
Maximum power output *1	P_{Omax}	THD = 10 %	3.6	4.1	—	W
Channel balance	CB	$V_{IN} = 90\text{ mV}$	-1	0	1	dB
Max. volume attenuation *1	Att	$V_{IN} = 90\text{ mV}$	—	-70	-64	dB
Mute attenuation *1	M_{Att}	$V_{IN} = 90\text{ mV}$	—	-70	-64	dB
Output noise voltage *1	V_{NO}	$R_g = 10\text{ k}\Omega$, Din-Audio Filter	—	0.6	1.0	mV[rms]
Ripple rejection *1	RR	$V_R = 280\text{ mV[rms]}$, $f_R = 100\text{ Hz}$ $R_g = 10\text{ k}\Omega$	30	35	—	dB

Note) *1 : With a filter band from 20 Hz to 20 kHz used.

• Design reference data

Note) The characteristic values below are theoretical values for designing and not guaranteed.

Parameter	Symbol	Conditions	Min	Typ	Max	Unit
Channel cross-talk	CT	$V_{OUT} = 1\text{ V[rms]}$, Volume = max.	47	57	—	dB
Max. power dissipation	P_{Dmax1}	Use 10 °C/W heat sink	—	5	7	W
Max. power dissipation	P_{Dmax2}	$V_{CC} = 15.6\text{ V}$, $R_L = 16\ \Omega$ No heat sink	—	1.9	—	W
Input dynamic range *2	DR_{IN}	THD = 1 %, $P_O = 1\text{ W}$	6.1	7.2	—	V[p-p]

Note) *2 : In order to measure input dynamic range correctly, it is necessary to reduce the gain by decreasing the DC volume to 1 V to 2 V.

■ Application Circuit Example

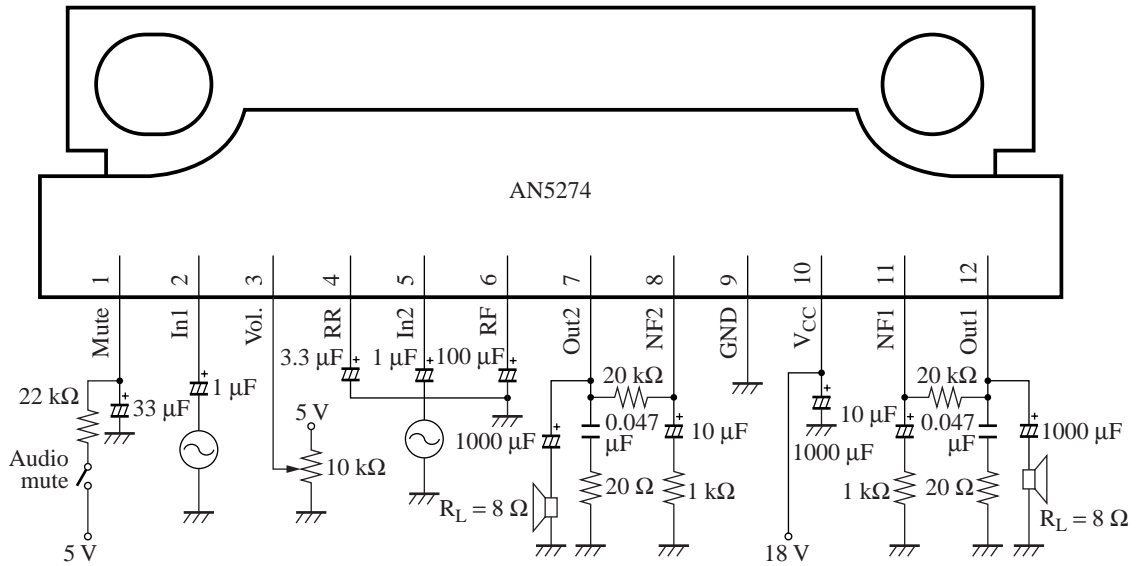

■ Usage Notes

- 1) Depending on the maximum application output power, external heatsink may be needed. External heatsink should be fixed to the chassis.
- 2) Fin of the IC can be connected to GND.
- 3) Please prevent output to V_{CC} short and output to GND short.
- 4) The temperature protection circuit will operate at T_j around 150 °C. However, if the temperature decreases, the protection circuit would automatically be deactivated and resume normal operation.

■ Technical Information

- HSIP012-P-0000A Package power dissipation

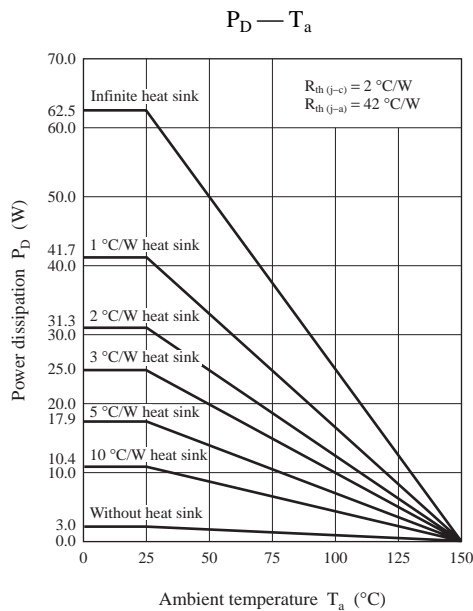

■ Technical Information (continued)

• Application Note

1) Voltage gain

The voltage gain of the AN5274 can be varied by changing the resistor R2 as shown below :

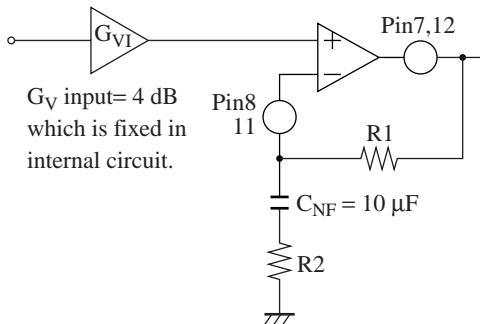

R1 is always fixed at 20 kΩ.

R2 is variable.

$$G_{VO} = 20 \log (R_1/R_2)$$

Typical values are : R₁ = 20 kΩ, R₂ = 1 kΩ

$$G_{VO} = 20 \log (20 \text{ k}/1 \text{ k}) = 26 \text{ dB}$$

$$G_{VTOTAL} = G_{VI} + G_{VO} = 4 \text{ dB} + 26 \text{ dB} = 30 \text{ dB}$$

2) DC volume control

The DC volume control range is 0 V to 5 V. This range is used in order to be easily controlled by micro-computer using PWM output. The recommended circuit and volume attenuation characteristic are shown below :

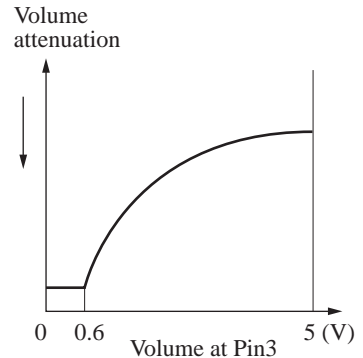
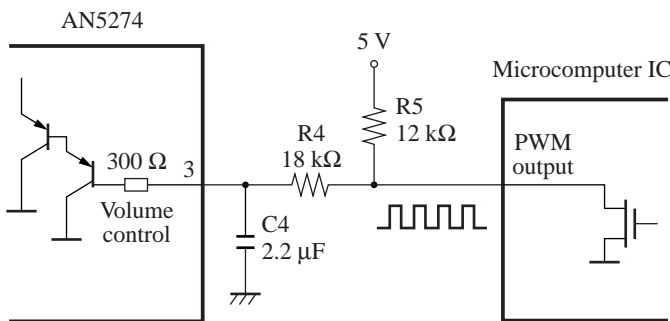
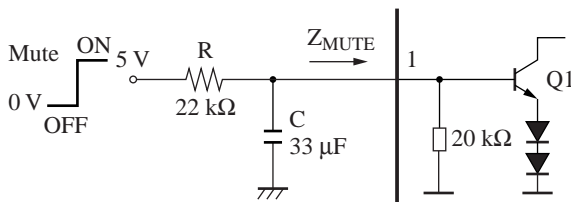

Fig. Volume control interface circuit for AN5274

Fig. Volume characteristic of AN5274

3) Mute control

Mute is ON when 5 V is applied to Pin1. Then Q1 would turn ON and able to drive other part of the circuits. The external RC components provide a time constant for switching ON and OFF.



The purpose of the Mute is to attenuate the AC signal before it goes to the output.

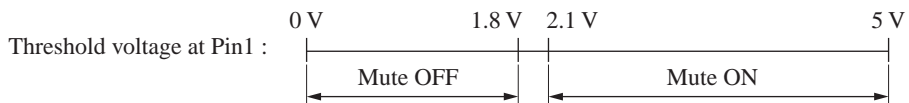

■ Technical Information (continued)

• Application Note (continued)

4) Oscillation

To prevent oscillation, it is advisable to use RC (Zobel network) at output. C of polyester film capacitor has smaller characteristic fluctuation with temperature and frequency. The resistor R connected in series with C is effective for phase correction at high frequency, and as a result, it improves the oscillation allowance.

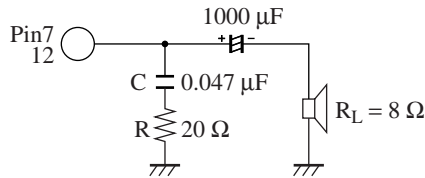

5) Power-ON/OFF pop-noise elimination

The output pins 7, 12 and V_O , during power turns ON and OFF are shown below :

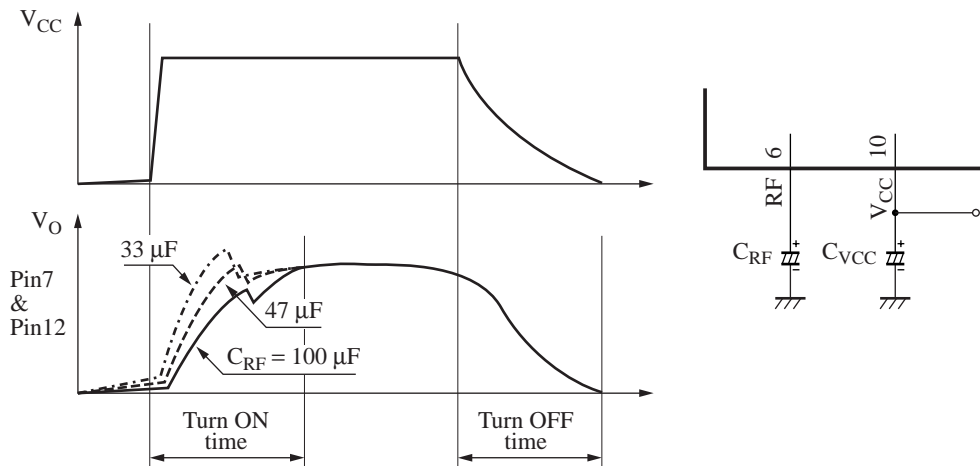

The turn ON time in the AN5274 is determined by the capacitance value of C_{RF} . If value of the C_{RF} is smaller, V_O will turn on faster.

The turn OFF time is dependent on the capacitance value of C_{VCC} . Pop-noise would occur when V_{CC} voltage declines faster than RF voltage. To solve this, increase the discharge time of V_{CC} by increasing the capacitance values of C_{VCC} .

The recommended values of capacitance for C_{VCC} and C_{RF} are shown below :

C_{RF}	C_{VCC}	Recommended Operating V_{CC} Range	Unit
33 μ F	470 μ F	14.5 to 27.5	V

■ Technical Information (continued)

• Application Note (continued)

6) Standby circuit

Standby function can be implemented in the AN5274 by external solution. It is realised by pulling the RF voltage to low and output voltage would follow RF as shown in the diagram.

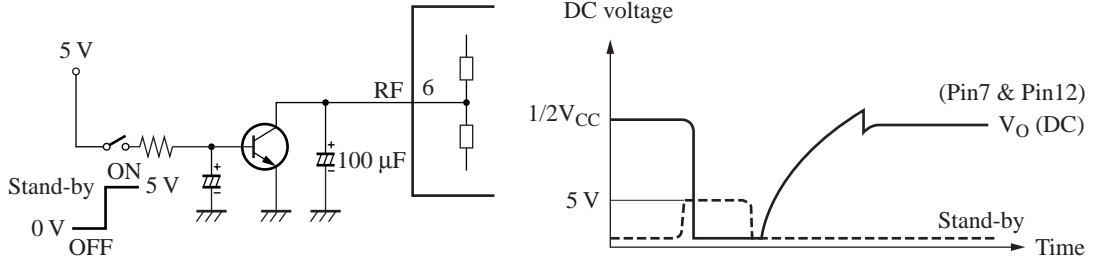

7) Ripple rejection improvement

The ripple rejection of the AN5274 can be improved by another 15 dB by connecting a capacitor to Pin4.

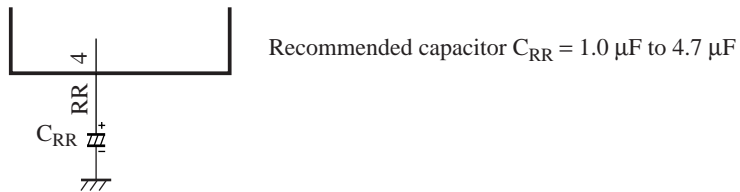

■ Technical Information (continued)

• Characteristic Curve Chart

$P_O, THD - V_{IN}$

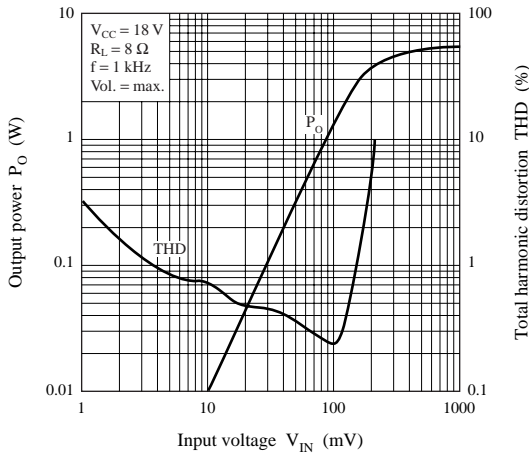

$P_O - V_{CC}$

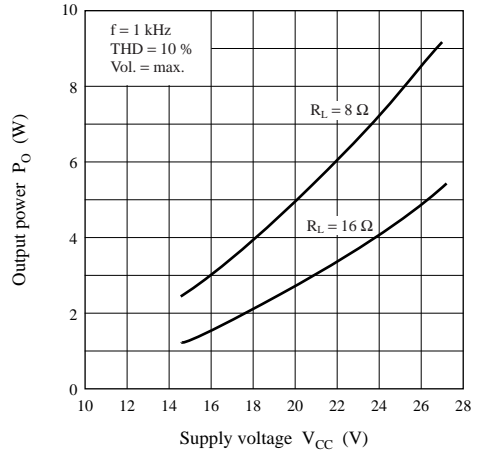

DC volume characteristics

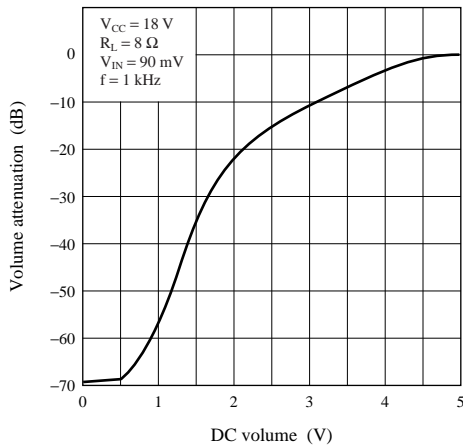

$G_V, THD - f$

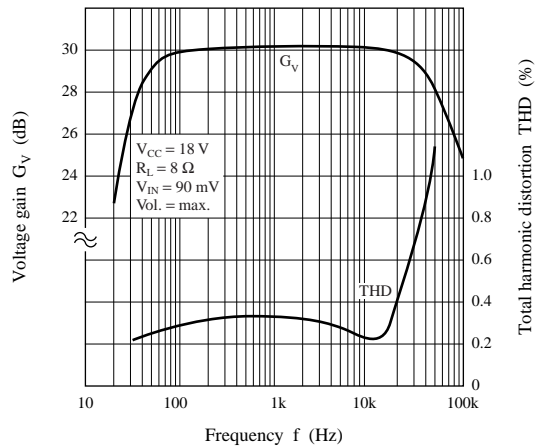

$RR - f$

