

AN5186FB

VIF/SIF IC for car-TV

■ Overview

The AN5186FB is a VIF/SIF signal processing IC for in-car television. The video and sound are completely separated by the adoption of split carrier method. Also, high performance and high function have been realized by the incorporation of in-car circuits such as soft mute and SD.

■ Features

- Split carrier method sound detection circuit
- Electric field detection and band detection type soft mute and SD
- Multipath detection circuit
- VIF uses quasi-synchronous detection which is invulnerable to electric field fluctuation.
- Video output pin for diversity detection (no noise inverter)

■ Applications

- In-car televisions

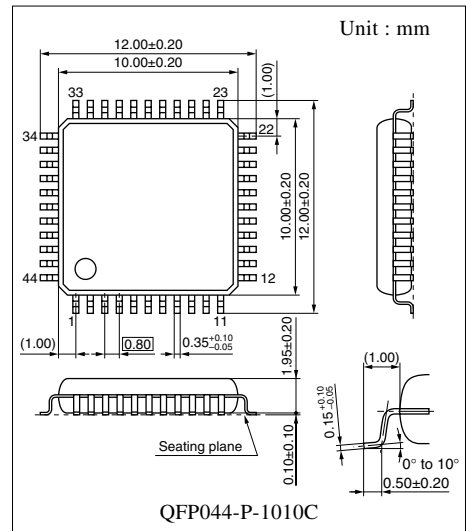

Note) The package of this product will be changed to lead-free type (QFP044-P-1010F). See the new package dimensions section later of this datasheet.

■ Block Diagram

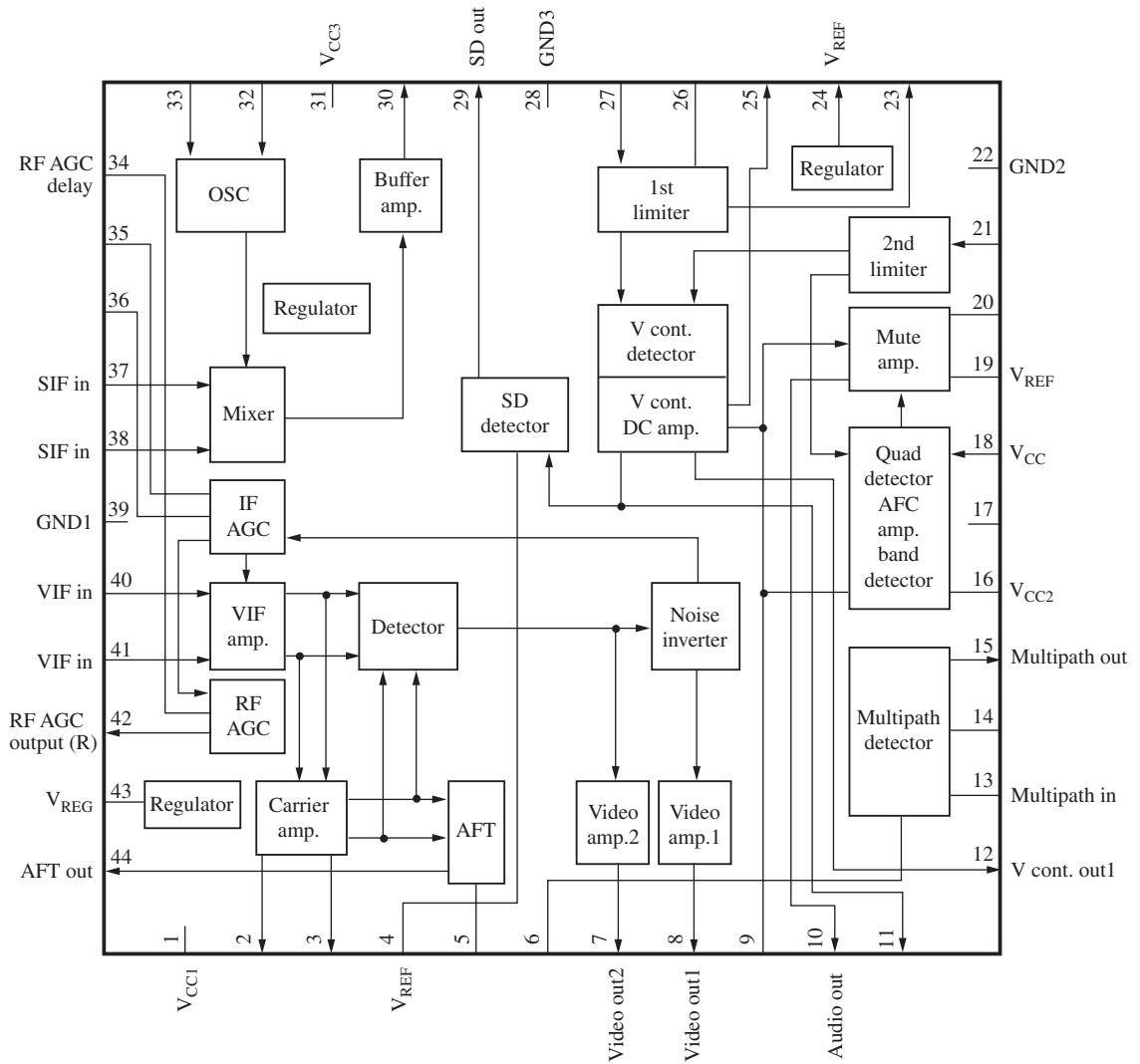

■ Pin Descriptions

Pin No.	Description	Pin No.	Description
1	V _{CC1}	10	Audio output
2	VIF detection coil 1	11	SMTC2
3	VIF detection coil 2	12	S meter output
4	SSC	13	AMDC input
5	AFT detection coil	14	AMDC detection
6	AMDC adjustment	15	AMDC output
7	Video output 2	16	AFC output
8	Video output 1	17	V _{CC2}
9	SMTC1	18	SIF detection coil

■ Pin Descriptions (continued)

Pin No.	Description	Pin No.	Description
19	SMA1	32	OSC1
20	SMA2	33	OSC2
21	2nd limiter input	34	RF AGC delay adjustment
22	GND2	35	IF AGC output
23	1st limiter output	36	IF AGC input
24	SIF reference voltage	37	SIF input 1
25	V cont. adjustment	38	SIF input 2
26	1st limiter bypass	39	GND 1
27	1st limiter input	40	VIF input 1
28	GND3	41	VIF input 2
29	SD output	42	RF AGC output
30	Mixer output	43	VIF reference voltage
31	V _{CC3}	44	AFT output

■ Absolute Maximum Ratings

Parameter	Symbol	Rating		Unit
Supply voltage	V _{CC}	V _{CC1} , V _{CC2} , V _{CC3}	10.2	V
Supply current	I _{CC}	I _{CC1} , I _{CC2} , I _{CC3}	80	mA
Power dissipation *2	P _D	425		mW
Operating ambient temperature *1	T _{opr}	-30 to +85		°C
Storage temperature *1	T _{stg}	-55 to +150		°C

Note) *1: T_a = 25°C except power dissipation, operating ambient temperature and storage temperature.

*2: The power dissipation is for the IC only when T_a = 85°C in free air.

■ Recommended Operating Range

Parameter	Symbol	Range	Unit
Supply voltage	V _{CC1} , V _{CC2} , V _{CC3}	7.2 to 10.0	V

■ Electrical Characteristics at $T_a = 25^\circ\text{C}$, $V_{CC1} = V_{CC2} = V_{CC3} = 8.0\text{ V}$

Parameter	Symbol	Conditions	Min	Typ	Max	Unit
VIF block						
Video detection output 1	V_{O8}	Video: 10 stairs – Y, $m = 87.5\%$	1.7	2.0	2.3	V[p-p]
Video detection output 2	V_{O7}	Video: 10 stairs – Y, $m = 87.5\%$	1.7	2.0	2.3	V[p-p]
Sync. peak value voltage 1	V_{P8}		2.7	3.1	3.5	V
Sync. peak value voltage 2	V_{P7}		2.7	3.1	3.5	V
Video frequency characteristic	f_C	Output –3dB frequency for 1 MHz	6	8	—	MHz
RF AGC operating sensitivity	G_{RF}	Input level difference to become $V_{42} = 1.5 \rightarrow 7\text{ V}$	—	1.0	3.0	dB
RF AGC maximum sink current	I_{AGCmax}	$V_{34} = 2.5\text{ V}$, $V_{36} = 2\text{ V}$	2.2	2.9	3.6	mA
RF AGC minimum sink current	I_{AGCmin}	$V_{34} = 2.5\text{ V}$, $V_{36} = 3\text{ V}$	–2	0	2	μA
AFT detection sensitivity	μ_{AFT}	$\Delta f = \pm 25\text{ kHz}$	13	20	27	mV/kHz
AFT maximum output voltage	V_{AFTmax}	$f = f_p - 500\text{ kHz}$	4.2	4.7	5.0	V
AFT minimum output voltage	V_{AFTmin}	$f = f_p + 500\text{ kHz}$	0	0.3	0.8	V
Video output resistance 1	R_{O8}	$V_{36} = 0\text{ V}$	20	50	120	Ω
Video output resistance 2	R_{O7}	$V_{36} = 0\text{ V}$	20	50	120	Ω
SIF block/mixer block						
S meter gradient 1	ΔV_{S1}	$f = 10.7\text{ MHz}$	1.3	1.7	2.1	V
S meter gradient 2	ΔV_{S2}	$f = 10.7\text{ MHz}$	1.45	1.85	2.25	V
Audio detection output	V_{OS}	$V_{IN27} = 70\text{ dB}\mu$, $f = 10.7\text{ MHz}$, $f_M = 1\text{ kHz}$, $\Delta f = \pm 25\text{ kHz}$	125	160	195	mV[rms]
Mix. conversion gain	V_{CG}	No modulation, $V_{IN37} = 70\text{ dB}\mu$	24	30	—	dB
Audio output resistance	R_{O10}		260	380	500	Ω
S meter output resistance (pin 12)	R_{O12}		60	160	260	Ω
Circuit current	I_{CC}	V_{CC1} , V_{CC2} , $V_{CC3} = 8.0\text{ V}$	51	63	75	mA

• Design reference data

Note) The characteristic values below are theoretical values for designing and not guaranteed.

Parameter	Symbol	Conditions	Min	Typ	Max	Unit
VIF block						
VIF input sensitivity	V_{VS}	Input level to become $V_{O8} = -3\text{ dB}$	—	42	49	dB μ
VIF maximum allowable input	V_{Vmax}	Input level to become $V_{O8} = +1\text{ dB}$	103	108	—	dB μ
Video S/N	S/N_V	BPF: 10k to 4M	50	56	—	dB
Differential gain	DG	Video: 10 – stairs	0	4	8	%
Differential phase	DP	Video: 10 – stairs	0	4	8	%
Intermodulation	IM	P/C = 2 dB, P/S = 12 dB	30	36	—	dB
Black noise detection level	ΔV_{BN}	Difference from sync. peak value voltage	—	–0.85	—	V
Black noise clamp level	ΔV_{BNC}	Difference from sync. peak value voltage	—	0.6	—	V

■ Electrical Characteristics at $T_a = 25^\circ\text{C}$, $V_{CC1} = V_{CC2} = V_{CC3} = 8.0\text{ V}$ (continued)

• Design reference data (continued)

Note) The characteristic values below are theoretical values for designing and not guaranteed.

Parameter	Symbol	Conditions	Min	Typ	Max	Unit
VIF block (continued)						
AFT defeat SW operating voltage	V_{AFTSW}		0.4	0.8	—	V
VIF input resistance	R_{140}	$f = 58.75\text{ MHz}$	—	1.8	—	$\text{k}\Omega$
VIF input capacitance	C_{140}	$f = 58.75\text{ MHz}$	—	3.2	—	pF
VIF reference voltage	V_{REG}		—	5.0	—	V
SIF/mixer block						
S meter voltage 1	V_{S1}	$V_{IN27} = \text{without input}$	0.05	0.5	1.1	V
S meter voltage 2	V_{S2}	$V_{IN27} = 40\text{ dB}\mu$	1.0	1.7	2.4	V
S meter voltage 3	V_{S3}	$V_{IN27} = 70\text{ dB}\mu$	2.3	3.4	4.5	V
S meter voltage 4	V_{S4}	$V_{IN27} = 100\text{ dB}\mu$	3.9	5.2	6.5	V
AFC offset voltage	V_{AFC}	$V_{IN27} = \text{without input}$	-0.1	0	0.1	V
Limiting sensitivity	V_{LIM}	$V_0 = 0\text{ dB}$, input for 3 dB down	—	32	38	$\text{dB}\mu$
SD sensitivity	SDS	Input when SD output becomes 4.5 V or more at $V_4 = 2\text{ V}$	—	38	—	$\text{dB}\mu$
SD bandwidth	SDW	Bandwidth when SD output becomes 4.5 V or more at $V_4 = 2\text{ V}$	—	140	—	kHz
SIF input resistance	R_{I37}	$f = 54.25\text{ MHz}$	—	2.7	—	$\text{k}\Omega$
SIF input capacitance	R_{C37}	$f = 54.25\text{ MHz}$	—	3.2	—	pF
Mixer output resistance	R_{O30}	$f = 10.7\text{ MHz}$	—	300	—	Ω
S/N sensitivity	N_{OUT}	$V_{IN37} = 22\text{ dB}\mu$ no modulation, however, S is the output when 1 kHz 100% modulation.	22	30	—	dB
Audio S/N	S/NA		60	65	—	dB
AM rejection ratio	AMR	$V_{IN27} = 70\text{ dB}\mu$, AM = 30%	48	54	—	dB
Total harmonic distortion	THD	$f_M = 1\text{ kHz}$, $\Delta f = \pm 25\text{ kHz}$	0	0.2	1.0	%
Soft mute attenuation	ΔMute		—	50	—	dB
Multipath detection	ΔV_{MP}	$f = 100\text{ kHz}$, $V_{IN13} = 70\text{ dB}\mu$, 110 $\text{dB}\mu$	—	1.5	—	V
SIF reference voltage	V_{REF}		—	4.1	—	V

■ Terminal Equivalent Circuits

Pin No.	Equivalent circuit	Description	voltage
1	—	Power supply pin 1: Power supply pin for VIF Use range; 7.2 V to 10 V (typ. 8 V)	DC (typ. 8 V) [Z = low]
2		VIF detection coil pin 1	$f_p = 58.75\text{M}$ $\angle 0^\circ$ phase shift DC, approx. 3.8 V [Z = 2.4 kΩ]
3		VIF detection coil pin 2	$f_p = 58.75\text{M}$ $\angle 0^\circ$ phase shift DC, approx. 3.8 V [Z = 2.4 kΩ]
4		SD detection adjusting pin: Detection sensitivity adjustment for SD output	DC approx. 2.1V [Z = 16 kΩ]
5		AFT detection coil pin	$f_p = 58.75\text{M}$ $\angle 90^\circ$ phase shift DC, approx. 2.6 V [Z = 6 kΩ]

■ Terminal Equivalent Circuits (continued)

Pin No.	Equivalent circuit	Description	voltage
6		Multipath detection adjusting pin: Detection sensitivity adjustment of multipath output	DC approx. 1.9 V [Z = 6.8 kΩ]
7		Video output pin 2	AC approx. 2 V[p-p] [Z = low]
8		Video output pin 1: Output after passing through noise inverter	
9		Soft mute filter pin 1	DC 0 V to 4.1V [Z = 25 kΩ]
10		Audio output pin	AC (differs according to input conditions) [Z = 380 Ω]

■ Terminal Equivalent Circuits (continued)

Pin No.	Equivalent circuit	Description	voltage
11		Soft mute filter pin 2: Adjusting voltage of ASC and ATC, etc.	DC [Z = 200 Ω]
12		S meter voltage output pin 1	DC 0 — ↗ Signal input level [Z = 270 kΩ]
13		Multipath input pin: Detection sensitivity is adjusted by external resistor.	DC approx. 1.9 V [Z = low]
14		Multipath detection pin	DC, approx. 1.2 V [Z = 6.3 kΩ] Rising low Falling 330 Ω
15		Multipath output pin	DC approx. 1.9 V (0 V to 4.1 V) [Z = 18 kΩ]
16		AFC output pin	DC approx. 4.2 V 5 V — — — 3.5 V

■ Terminal Equivalent Circuits (continued)

Pin No.	Equivalent circuit	Description	voltage
17	—	Power supply pin 2: Power supply pin for SIF Use range; 7.2 V to 10.0 V (typ. 8 V)	DC (typ. 8 V)
18		SIF detection coil pin	AC approx. 0.9 V[p-p] ∠90° phase shift DC, approx. 8 V [Z = high]
19		Soft mute adjusting pin 1: Soft mute start point adjustment	DC (0 to V_{REF}) (4.2 V) (voltage input from outside) [Z = high]
20		Soft mute adjusting pin 2: Soft mute gradient adjustment	DC [Z = low]
21		2nd limiter input pin	DC = 0 V [Z = 300 Ω]

■ Terminal Equivalent Circuits (continued)

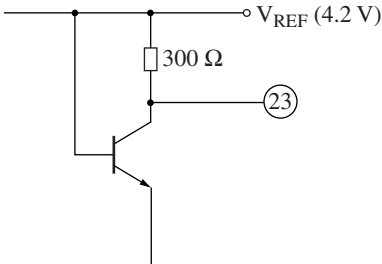
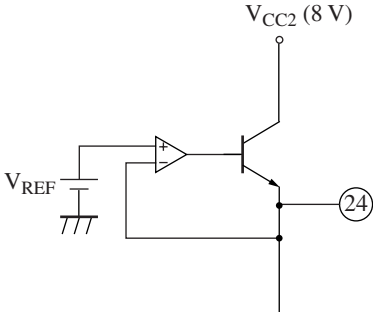
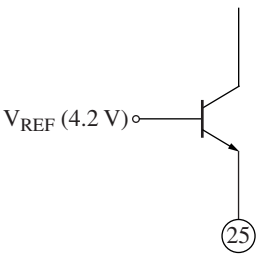
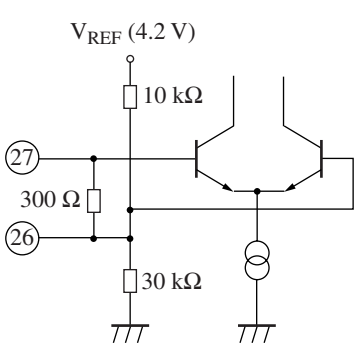
Pin No.	Equivalent circuit	Description	voltage
22		GND pin 2: GND pin for SIF	— [Z = low]
23		1st limiter output pin	AC fs = 10.7M DC approx. 4.0 V [Z = 500 Ω]
24		SIF reference voltage: Reference voltage pin for SIF	DC approx. 4.2 V [Z = low]
25		S meter voltage adjusting pin	DC approx. 3.5 V [Z = low]
26		1st limiter bias pin	DC approx. 3.1 V [Z = 7.5 kΩ]
27		1st limiter input pin	AC fs = 10.7M DC approx. 3.1 V [Z = 300 Ω]

■ Terminal Equivalent Circuits (continued)

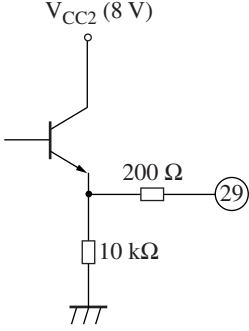
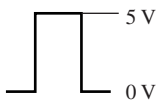
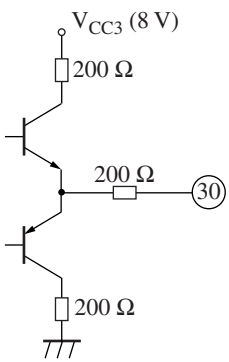
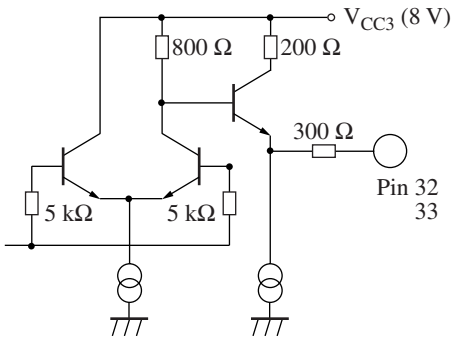
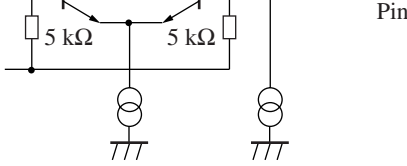
Pin No.	Equivalent circuit	Description	voltage
28		GND pin 3: GND pin for mixer	— [Z = low]
29		SD output pin	 [Z = 200 Ω]
30		Mixer output pin	AC [Z = 200 Ω]
31	—	Power supply pin 3: Power supply pin for mixer Use range; 7.2 V to 10.0 V (typ. 8 V)	DC (typ. 8 V) [Z = low]
32		OSC input pin 1	DC approx. 7.0 V [Z = 300 Ω]
33		OSC input pin 2	DC approx. 4.4 V [Z = 5 kΩ]

Terminal Equivalent Circuits (continued)

Pin No.	Equivalent circuit	Description	voltage
34		RF AGC delay adjusting pin	DC approx. 4.4 V [Z = high]
35		IF AGC output pin	DC [Z = high]
36		IF AGC input pin	DC [Z = high]
37		SIF input pin 1	AC f = f _s (54.25 MHz) DC level approx. 2.7 V
38		SIF input pin 2	[Z = 3 kΩ]

■ Terminal Equivalent Circuits (continued)

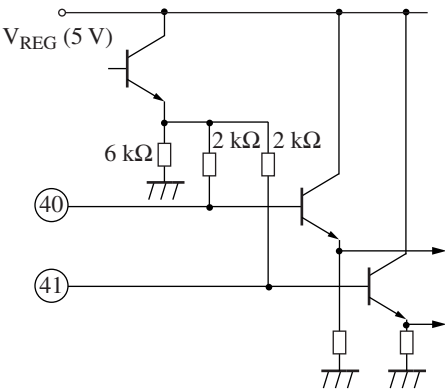
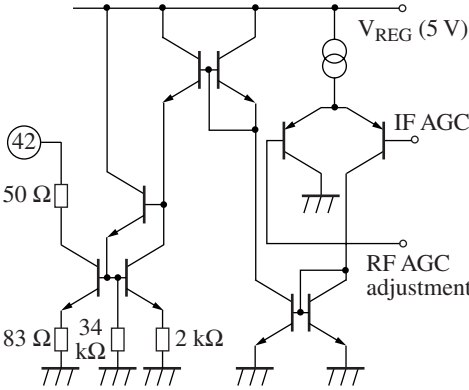
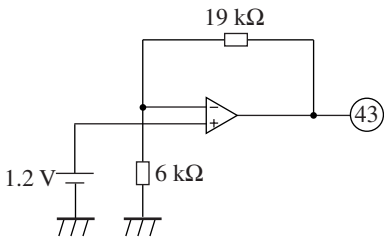
Pin No.	Equivalent circuit	Description	voltage
39		GND pin 1: GND pin for VIF	— [Z = low]
40		VIF input pin 1	AC f = fp (58.75 MHz) DC level approx. 2.6 V
41		VIF input pin 2: Input for VIF amp. and balanced input	[Z = 2 kΩ]
42		RF AGC output pin: Collector open output so that arbitrary bias is usable. (max. 12.5 V)	DC
43		VIF reference voltage pin: Reference voltage pin for VIF	DC level approx. 5 V [Z = low]

Terminal Equivalent Circuits (continued)

Pin No.	Equivalent circuit	Description	voltage
44		AFT output pin	DC [Z = high]

Application Circuit Example

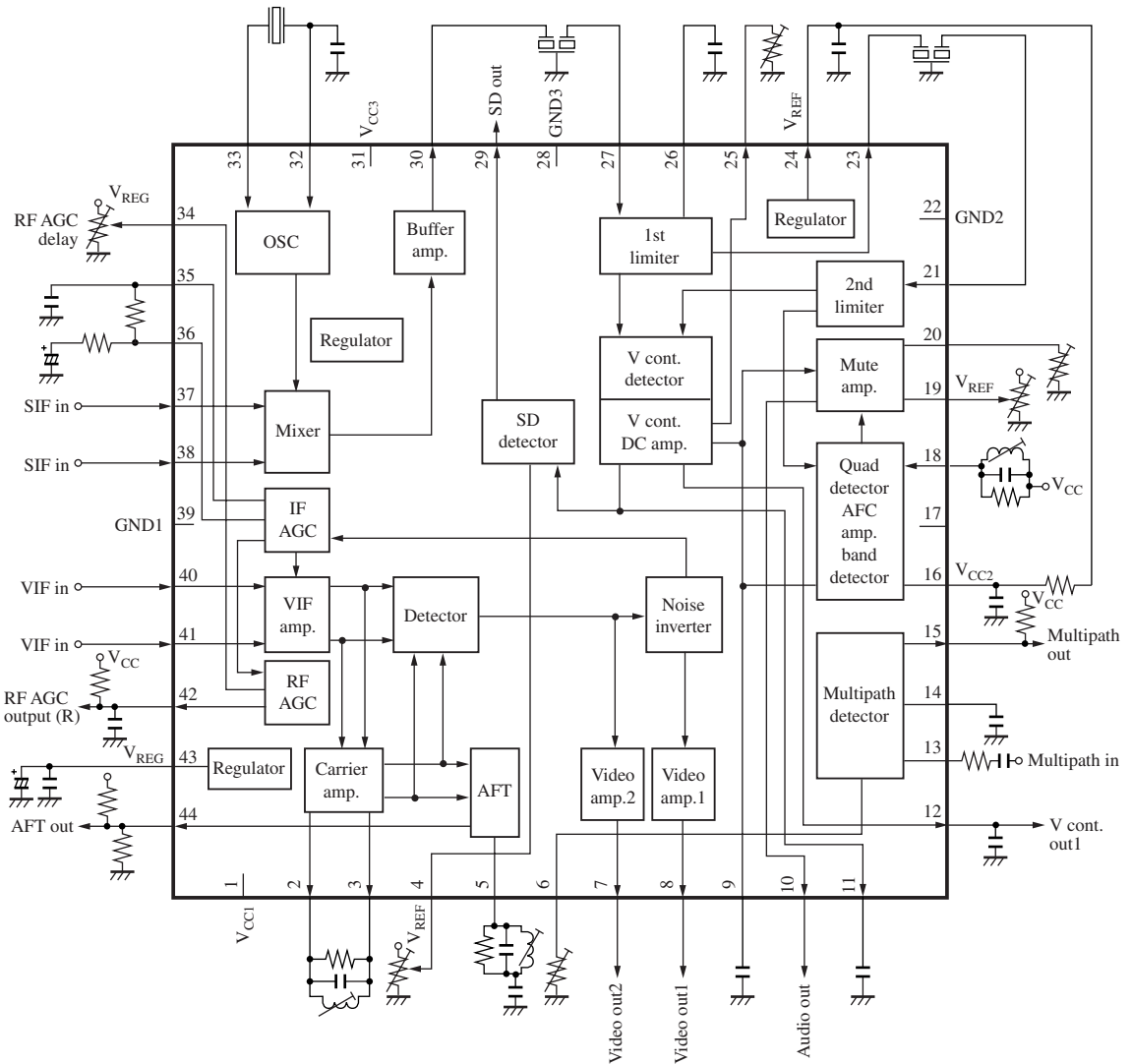

Request for your special attention and precautions in using the technical information and semiconductors described in this material

- (1) An export permit needs to be obtained from the competent authorities of the Japanese Government if any of the products or technologies described in this material and controlled under the "Foreign Exchange and Foreign Trade Law" is to be exported or taken out of Japan.
- (2) The technical information described in this material is limited to showing representative characteristics and applied circuit examples of the products. It does not constitute the warranting of industrial property, the granting of relative rights, or the granting of any license.
- (3) The products described in this material are intended to be used for standard applications or general electronic equipment (such as office equipment, communications equipment, measuring instruments and household appliances).
Consult our sales staff in advance for information on the following applications:
 - Special applications (such as for airplanes, aerospace, automobiles, traffic control equipment, combustion equipment, life support systems and safety devices) in which exceptional quality and reliability are required, or if the failure or malfunction of the products may directly jeopardize life or harm the human body.
 - Any applications other than the standard applications intended.
- (4) The products and product specifications described in this material are subject to change without notice for reasons of modification and/or improvement. At the final stage of your design, purchasing, or use of the products, therefore, ask for the most up-to-date Product Standards in advance to make sure that the latest specifications satisfy your requirements.
- (5) When designing your equipment, comply with the guaranteed values, in particular those of maximum rating, the range of operating power supply voltage and heat radiation characteristics. Otherwise, we will not be liable for any defect which may arise later in your equipment.
Even when the products are used within the guaranteed values, redundant design is recommended, so that such equipment may not violate relevant laws or regulations because of the function of our products.
- (6) When using products for which dry packing is required, observe the conditions (including shelf life and after-unpacking standby time) agreed upon when specification sheets are individually exchanged.
- (7) No part of this material may be reprinted or reproduced by any means without written permission from our company.

Please read the following notes before using the datasheets

- A. These materials are intended as a reference to assist customers with the selection of Panasonic semiconductor products best suited to their applications.
Due to modification or other reasons, any information contained in this material, such as available product types, technical data, and so on, is subject to change without notice.
Customers are advised to contact our semiconductor sales office and obtain the latest information before starting precise technical research and/or purchasing activities.
- B. Panasonic is endeavoring to continually improve the quality and reliability of these materials but there is always the possibility that further rectifications will be required in the future. Therefore, Panasonic will not assume any liability for any damages arising from any errors etc. that may appear in this material.
- C. These materials are solely intended for a customer's individual use.
Therefore, without the prior written approval of Panasonic, any other use such as reproducing, selling, or distributing this material to a third party, via the Internet or in any other way, is prohibited.