

ADSP-21061/ADSP-21061L
SUMMARY

High-Performance Signal Computer for Speech, Sound, Graphics and Imaging Applications

Super Harvard Architecture Computer (SHARC)—
Four Independent Buses for Dual Data, Instructions, and I/O

32-Bit IEEE Floating-Point Computation Units—
Multiplier, ALU and Shifter

1 Megabit On-Chip SRAM Memory and Integrated I/O
Peripherals—A Complete System-On-A-Chip
Integrated Multiprocessing Features

KEY FEATURES

50 MIPS, 20 ns Instruction Rate, Single-Cycle Instruction Execution

120 MFLOPS Peak, 80 MFLOPS Sustained Performance
Dual Data Address Generators with Modulo and Bit-Reverse Addressing

Efficient Program Sequencing with Zero-Overhead Looping: Single-Cycle Loop Setup

IEEE JTAG Standard 1149.1 Test Access Port and On-Chip Emulation

240-Lead PQFP Package

Pin-Compatible with ADSP-21060 (4 Mbit) and ADSP-21062 (2 Mbit)

Flexible Data Formats and 40-Bit Extended Precision
32-Bit Single-Precision and 40-Bit Extended-Precision IEEE Floating-Point Data Formats

32-Bit Fixed-Point Data Format, Integer and Fractional, with 80-Bit Accumulators

Parallel Computations

Single-Cycle Multiply and ALU Operations in Parallel with Dual Memory Read/Writes and Instruction Fetch

Multiply with Add and Subtract for Accelerated FFT Butterfly Computation

1024-Point Complex FFT Benchmark: 0.37 ms (18,221 Cycles)

1 Megabit Configurable On-Chip SRAM

Dual-Ported for Independent Access by Core Processor and DMA

Configurable as 32K Words Data Memory (32-Bit), 16K Words Program Memory (48-Bit) or Combinations of Both Up to 1 Mbit

Off-Chip Memory Interfacing

4-Gigawords Addressable (32-Bit Address)

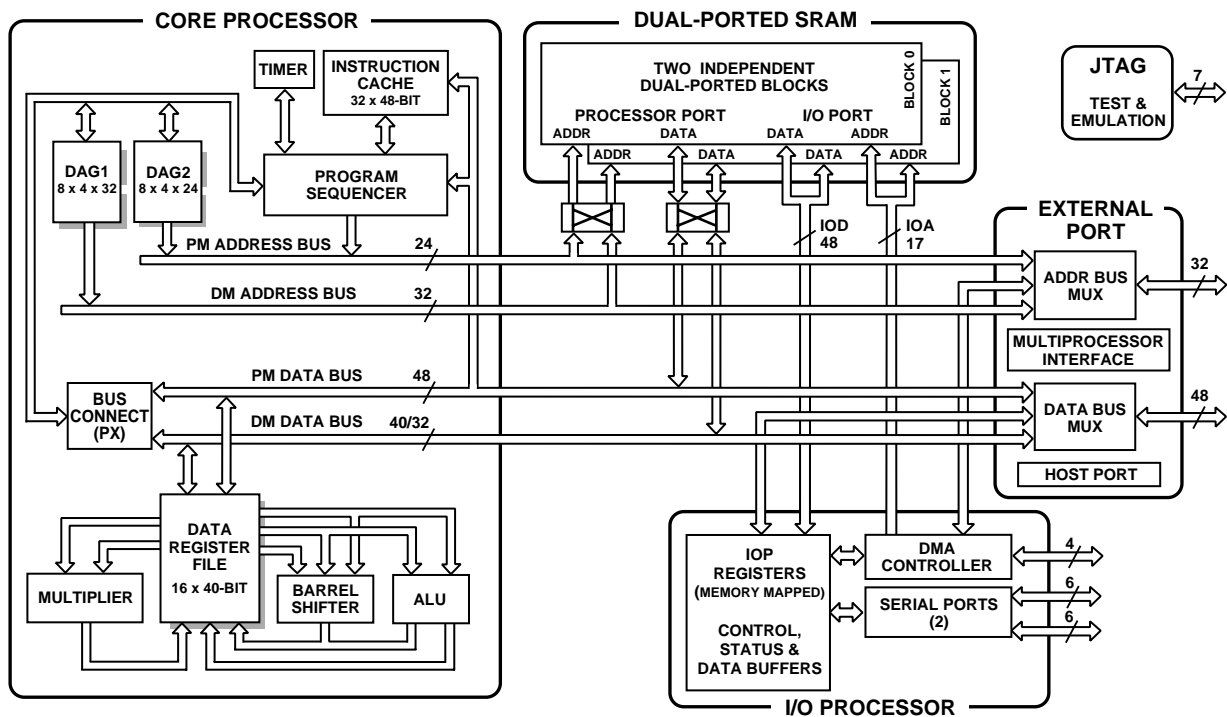

Figure 1. ADSP-21061/ADSP-21061L Block Diagram

SHARC is a registered trademark of Analog Devices, Inc.

REV. 0

Information furnished by Analog Devices is believed to be accurate and reliable. However, no responsibility is assumed by Analog Devices for its use, nor for any infringements of patents or other rights of third parties which may result from its use. No license is granted by implication or otherwise under any patent or patent rights of Analog Devices.

ADSP-21061/ADSP-21061L

Programmable Wait State Generation, Page-Mode DRAM Support

DMA Controller

6 DMA Channels

Background DMA Transfers at 50 MHz, in Parallel with Full-Speed Processor Execution

Performs Transfers Between ADSP-21061 Internal Memory and External Memory, External

Peripherals, Host Processor, or Serial Ports

Host Processor Interface

Efficient Interface to 16- and 32-Bit Microprocessors

Host can Directly Read/Write ADSP-21061 Internal Memory

Multiprocessing

Glueless Connection for Scalable DSP Multiprocessing Architecture

Distributed On-Chip Bus Arbitration for Parallel Bus

Connect of Up To Six ADSP-21061s Plus Host
300 Mbytes/s Transfer Rate Over Parallel Bus

Serial Ports

Two 40 Mbit/s Synchronous Serial Ports

Independent Transmit and Receive Functions

3- to 32-Bit Data Word Width

μ -Law/A-Law Hardware Companding

TDM Multichannel Mode

Multichannel Signaling Protocol

TABLE OF CONTENTS

GENERAL DESCRIPTION	3
ADSP-21000 FAMILY CORE ARCHITECTURE	4
ADSP-21061 FEATURES	4
DEVELOPMENT TOOLS	8
ADDITIONAL INFORMATION	8
PIN FUNCTION DESCRIPTIONS	9
TARGET BOARD CONNECTOR FOR EZ-ICE®	
PROBE	12
RECOMMENDED OPERATING CONDITIONS (5 V)	14
ELECTRICAL CHARACTERISTICS (5 V)	14
POWER DISSIPATION ADSP-21061 (5 V)	15
RECOMMENDED OPERATING CONDITIONS (3.3 V)	16
ELECTRICAL CHARACTERISTICS (3.3 V)	16
POWER DISSIPATION ADSP-21061L (3.3 V)	17
ABSOLUTE MAXIMUM RATINGS	18
TIMING SPECIFICATIONS	18
Memory Read—Bus Master	21
Memory Write—Bus Master	22
Synchronous Read/Write—Bus Master	23
Synchronous Read/Write—Bus Slave	25
Multiprocessor Bus Request and Host Bus Request	26
Asynchronous Read/Write—Host to ADSP-21061	28
Three-State Timing—Bus Master, Bus Slave, HBR, SBTS	30
DMA Handshake	32
Serial Ports	34
JTAG Test Access Port and Emulation	37
OUTPUT DRIVE CURRENTS	38
POWER DISSIPATION	38
TEST CONDITIONS	38
ENVIRONMENTAL CONDITIONS	38
240-LEAD METRIC PQFP PIN CONFIGURATIONS	42
PACKAGE DIMENSIONS	43, 44
ORDERING GUIDE	44

FIGURES

Figure 1. ADSP-21061/ADSP-21061L Block Diagram	1
Figure 2. ADSP-21061/ADSP-21061L System	4
Figure 3. Multiprocessing System	6
Figure 4. ADSP-21061/ADSP-21061L Memory Map	7
Figure 5. Target Board Connector For ADSP-21061/ ADSP-21061L EZ-ICE Emulator (Jumpers in Place)	12
Figure 6. JTAG Scan Path Connections for Multiple ADSP-21061/ADSP-21061L Systems	12

Figure 7. JTAG Clocktree for Multiple ADSP-21061/ ADSP-21061L Systems	13
Figure 8. Clock Input	19
Figure 9. Reset	19
Figure 10. Interrupts	20
Figure 11. Timer	20
Figure 12. Flags	20
Figure 13. Memory Read—Bus Master	21
Figure 14. Memory Write—Bus Master	22
Figure 15. Synchronous Read/Write—Bus Master	24
Figure 16. Synchronous Read/Write—Bus Slave	25
Figure 17. Multiprocessor Bus Request and Host Bus Request	27
Figure 18a. Synchronous REDY Timing	28
Figure 18b. Asynchronous Read/Write—Host to ADSP-21061/ADSP-21061L	29
Figure 19a. Three-State Timing (Bus Transition Cycle, SBTS Assertion)	31
Figure 19b. Three-State Timing (Host Transition Cycle)	31
Figure 20. DMA Handshake Timing	33
Figure 21. Serial Ports	35
Figure 22. External Late Frame Sync	36
Figure 23. JTAG Test Access Port and Emulation	37
Figure 24. Output Enable/Disable	39
Figure 25. Equivalent Device Loading for AC Measurements (Includes All Fixtures)	39
Figure 26. Voltage Reference Levels for AC Measurements (Except Output Enable/Disable)	39
Figure 27. ADSP-2106x Typical Drive Currents ($V_{DD} = 5 V$)	40
Figure 28. Typical Output Rise Time (10%–90% V_{DD}) vs. Load Capacitance ($V_{DD} = 5 V$)	40
Figure 29. Typical Output Rise Time (0.8 V–2.0 V) vs. Load Capacitance ($V_{DD} = 5 V$)	40
Figure 30. Typical Output Delay or Hold vs. Load Capacitance (at Maximum Case Temperature) ($V_{DD} = 5 V$)	40
Figure 31. ADSP-2106x Typical Drive Currents ($V_{DD} = 3.3 V$)	40
Figure 32. Typical Output Rise Time (10%–90% V_{DD}) vs. Load Capacitance ($V_{DD} = 3.3 V$)	40
Figure 33. Typical Output Rise Time (0.8 V–2.0 V) vs. Load Capacitance ($V_{DD} = 3.3 V$)	41
Figure 34. Typical Output Delay or Hold vs. Load Capacitance (at Maximum Case Temperature) ($V_{DD} = 3.3 V$)	41



GENERAL NOTE

This data sheet represents production released specifications for the ADSP-21061 5 V and ADSP-21061L 3.3 V processors. ADSP-21061 is used throughout this data sheet to refer to both devices unless expressly noted.

GENERAL DESCRIPTION

The ADSP-21061 is a member of the powerful SHARC family of floating point processors. The SHARC—Super Harvard Architecture Computer—are signal processing microcomputers that offer new capabilities and levels of integration and performance. The ADSP-21061 is a 32-bit processor optimized for high performance DSP applications. The ADSP-21061 combines the ADSP-21000 DSP core with a dual-ported on-chip SRAM and an I/O processor with a dedicated I/O bus to form a complete system-in-a-chip.

Fabricated in a high-speed, low-power CMOS process, the ADSP-21061 has a 20 ns instruction cycle time operating at up to 50 MIPS. With its on-chip instruction cache, the processor can execute every instruction in a single cycle. Table I shows performance benchmarks for the ADSP-21061/ADSP-21061L.

The ADSP-21061 SHARC combines a high-performance floating-point DSP core with integrated, on-chip system features, including a 1 Mbit SRAM memory, host processor interface, DMA controller, serial ports and parallel bus connectivity for glueless DSP multiprocessing.

Figure 1 shows a block diagram of the ADSP-21061/ADSP-21061L, illustrating the following architectural features:

- Computation Units (ALU, Multiplier and Shifter) with a Shared Data Register File
- Data Address Generators (DAG1, DAG2)
- Program Sequencer with Instruction Cache
- Interval Timer
- 1 Mbit On-Chip SRAM
- External Port for Interfacing to Off-Chip Memory and Peripherals
- Host Port & Multiprocessor Interface
- DMA Controller
- Serial Ports
- JTAG Test Access Port

Figure 2 shows a typical single-processor system. A multi-processing system is shown in Figure 3.

Table I. ADSP-21061/ADSP-21061L Benchmarks (@ 50 MHz)

1024-Pt. Complex FFT (Radix 4, with Digit Reverse)	0.37 ms	18,221 Cycles
FIR Filter (per Tap)	20 ns	1 Cycle
IIR Filter (per Biquad)	80 ns	4 Cycles
Divide (y/x)	120 ns	6 Cycles
Inverse Square Root ($1/\sqrt{x}$)	180 ns	9 Cycles
DMA Transfer Rate	300 Mbytes/s	

ADSP-21061/ADSP-21061L

ADSP-21000 FAMILY CORE ARCHITECTURE

The ADSP-21061 includes the following architectural features of the ADSP-21000 family core. The ADSP-21061 is code and function compatible with the ADSP-21060/ADSP-21062 and the ADSP-21020.

Independent, Parallel Computation Units

The arithmetic/logic unit (ALU), multiplier and shifter all perform single-cycle instructions. The three units are arranged in parallel, maximizing computational throughput. Single multi-function instructions execute parallel ALU and multiplier operations. These computation units support IEEE 32-bit single-precision floating-point, extended precision 40-bit floating-point and 32-bit fixed-point data formats.

Instruction Cache

The ADSP-21061 includes an on-chip instruction cache that enables three-bus operation for fetching an instruction and two data values. The cache is selective—only the instructions whose fetches conflict with PM bus data accesses are cached. This allows full-speed execution of core, looped operations such as digital filter multiply-accumulates and FFT butterfly processing.

Data Address Generators with Hardware Circular Buffers

The ADSP-21061's two data address generators (DAGs) implement circular data buffers in hardware. Circular buffers allow efficient programming of delay lines and other data structures required in digital signal processing, and are commonly used in digital filters and Fourier transforms. The ADSP-21061 two DAGs contain sufficient registers to allow the creation of up to 32 circular buffers (16 primary register sets, 16 secondary). The DAGs automatically handle address pointer wraparound, reducing overhead, increasing performance and simplifying implementation. Circular buffers can start and end at any memory location.

Flexible Instruction Set

The 48-bit instruction word accommodates a variety of parallel operations, for concise programming. For example, the ADSP-21061 can conditionally execute a multiply, an add, a subtract and a branch, all in a single instruction.

ADSP-21061 FEATURES

Augmenting the ADSP-21000 family core, the ADSP-21061 adds the following architectural features:

Dual-Ported On-Chip Memory

The ADSP-21061 contains 1 megabit of on-chip SRAM, organized as two banks of 0.5 Mbits each. Each bank has eight 16-bit columns with 4K 16-bit words per column. Each memory block is dual-ported for single-cycle, independent accesses by the core processor and I/O processor or DMA controller. The dual-ported memory and separate on-chip buses allow two data transfers from the core and one from I/O, all in a single cycle (see Figure 4 for the ADSP-21061 Memory Map).

On the ADSP-21061, the memory can be configured as a maximum of 32K words of 32-bit data, 64K words for 16-bit data, 16K words of 48-bit instructions (and 40-bit data) or combinations of different word sizes up to 1 megabit. All the memory can be accessed as 16-bit, 32-bit or 48-bit.

A 16-bit floating-point storage format is supported that effectively doubles the amount of data that may be stored on chip. Conversion between the 32-bit floating-point and 16-bit floating-point formats is done in a single instruction.

While each memory block can store combinations of code and data, accesses are most efficient when one block stores data, using the DM bus for transfers, and the other block stores instructions and data, using the PM bus for transfers. Using the DM and PM buses in this way, with one dedicated to each memory block, assures single-cycle execution with two data transfers. In this case, the instruction must be available in the cache. Single-cycle execution is also maintained when one of the data operands is transferred to or from off-chip, via the ADSP-21061's external port.

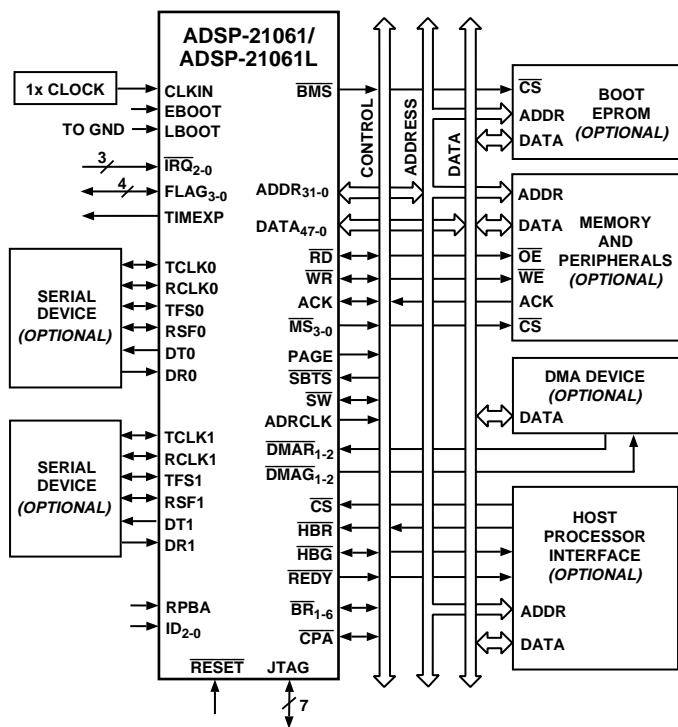

Figure 2. ADSP-21061/ADSP-21061L System

Data Register File

A general purpose data register file is used for transferring data between the computation units and the data buses, and for storing intermediate results. This 10-port, 32-register (16 primary, 16 secondary) register file, combined with the ADSP-21000 Harvard architecture, allows unconstrained data flow between computation units and internal memory.

Single-Cycle Fetch of Instruction and Two Operands

The ADSP-21061 features an enhanced Harvard architecture in which the data memory (DM) bus transfers data and the program memory (PM) bus transfers both instructions and data (see Figure 1). With its separate program and data memory buses and on-chip instruction cache, the processor can simultaneously fetch two operands and an instruction (from the cache), all in a single cycle.

Off-Chip Memory and Peripherals Interface

The ADSP-21061's external port provides the processor's interface to off-chip memory and peripherals. The 4-gigaword off-chip address space is included in the ADSP-21061's unified address space. The separate on-chip buses—for program memory, data memory and I/O—are multiplexed at the external port to create an external system bus with a single 32-bit address bus and a single 48-bit (or 32-bit) data bus. The on-chip Super Harvard Architecture provides three-bus performance, while the off-chip unified address space gives flexibility to the designer.

Addressing of external memory devices is facilitated by on-chip decoding of high order address lines to generate memory bank select signals. Separate control lines are also generated for simplified addressing of page-mode DRAM. The ADSP-21061 provides programmable memory wait states and external memory acknowledge controls to allow interfacing to DRAM and peripherals with variable access, hold and disable time requirements.

Host Processor Interface

The ADSP-21061's host interface allows easy connection to standard microprocessor buses, both 16-bit and 32-bit, with little additional hardware required. Asynchronous transfers at speeds up to the full clock rate of the processor are supported. The host interface is accessed through the ADSP-21061's external port and is memory-mapped into the unified address space. Two channels of DMA are available for the host interface; code and data transfers are accomplished with low software overhead.

The host processor requests the ADSP-21061's external bus with the host bus request ($\overline{\text{HBR}}$), host bus grant ($\overline{\text{HBG}}$) and ready (REDY) signals. The host can directly read and write the internal memory of the ADSP-21061, and can access the DMA channel setup and mailbox registers. Vector interrupt support is provided for efficient execution of host commands.

DMA Controller

The ADSP-21061's on-chip DMA controller allows zero-overhead, nonintrusive data transfers without processor intervention. The DMA controller operates independently and invisibly to the processor core, allowing DMA operations to occur while the core is simultaneously executing its program instructions.

DMA transfers can occur between the ADSP-21061's internal memory and either external memory, external peripherals, or a host processor. DMA transfers can also occur between the ADSP-21061's internal memory and its serial ports. DMA transfers between external memory and external peripheral devices are another option. External bus packing to 16-, 32- or 48-bit words is performed during DMA transfers.

Six channels of DMA are available on the ADSP-21061—four via the serial ports, and two via the processor's external port (for either host processor, other ADSP-21061s, memory or I/O transfers). Programs can be downloaded to the ADSP-21061 using DMA transfers. Asynchronous off-chip peripherals can control two DMA channels using DMA Request/Grant lines ($\overline{\text{DMAR}}_{1-2}$, $\overline{\text{DMAG}}_{1-2}$). Other DMA features include interrupt generation upon completion of DMA transfers and DMA chaining for automatic linked DMA transfers.

Serial Ports

The ADSP-21061 features two synchronous serial ports that provide an inexpensive interface to a wide variety of digital and mixed-signal peripheral devices. The serial ports can operate at the full clock rate of the processor, providing each with a maximum data rate of 40 Mbit/s. Independent transmit and receive functions provide greater flexibility for serial communications. Serial port data can be automatically transferred to and from on-chip memory via DMA. Each of the serial ports offers TDM multichannel mode.

The serial ports can operate with little-endian or big-endian transmission formats, with word lengths selectable from three bits to 32 bits. They offer selectable synchronization and transmit modes as well as optional μ -law or A-law companding. Serial port clocks and frame syncs can be internally or externally generated. The serial ports also include keyword and keymask features to enhance interprocessor communication.

Multiprocessing

The ADSP-21061 offers powerful features tailored to multiprocessing DSP systems. The unified address space allows direct interprocessor accesses of each ADSP-21061's internal memory. Distributed bus arbitration logic is included on-chip for simple, glueless connection of systems containing up to six ADSP-21061s and a host processor. Master processor changeover incurs only one cycle of overhead. Bus arbitration is selectable as either fixed or rotating priority. Bus lock allows indivisible read-modify-write sequences for semaphores. A vector interrupt is provided for interprocessor commands. Maximum throughput for interprocessor data transfer is 500 Mbytes/sec over the external port. Broadcast writes allow simultaneous transmission of data to all ADSP-21061s and can be used to implement reflective semaphores.

Program Booting

The internal memory of the ADSP-21061 can be booted at system power-up from either an 8-bit EPROM or a host processor. Selection of the boot source is controlled by the $\overline{\text{BMS}}$ (Boot Memory Select), EBOOT (EPROM Boot), and LBOOT (Host Boot) pins. 32-bit and 16-bit host processors can be used for booting. See the $\overline{\text{BMS}}$ pin in the Pin Function Descriptions section of this data sheet.

ADSP-21061/ADSP-21061L

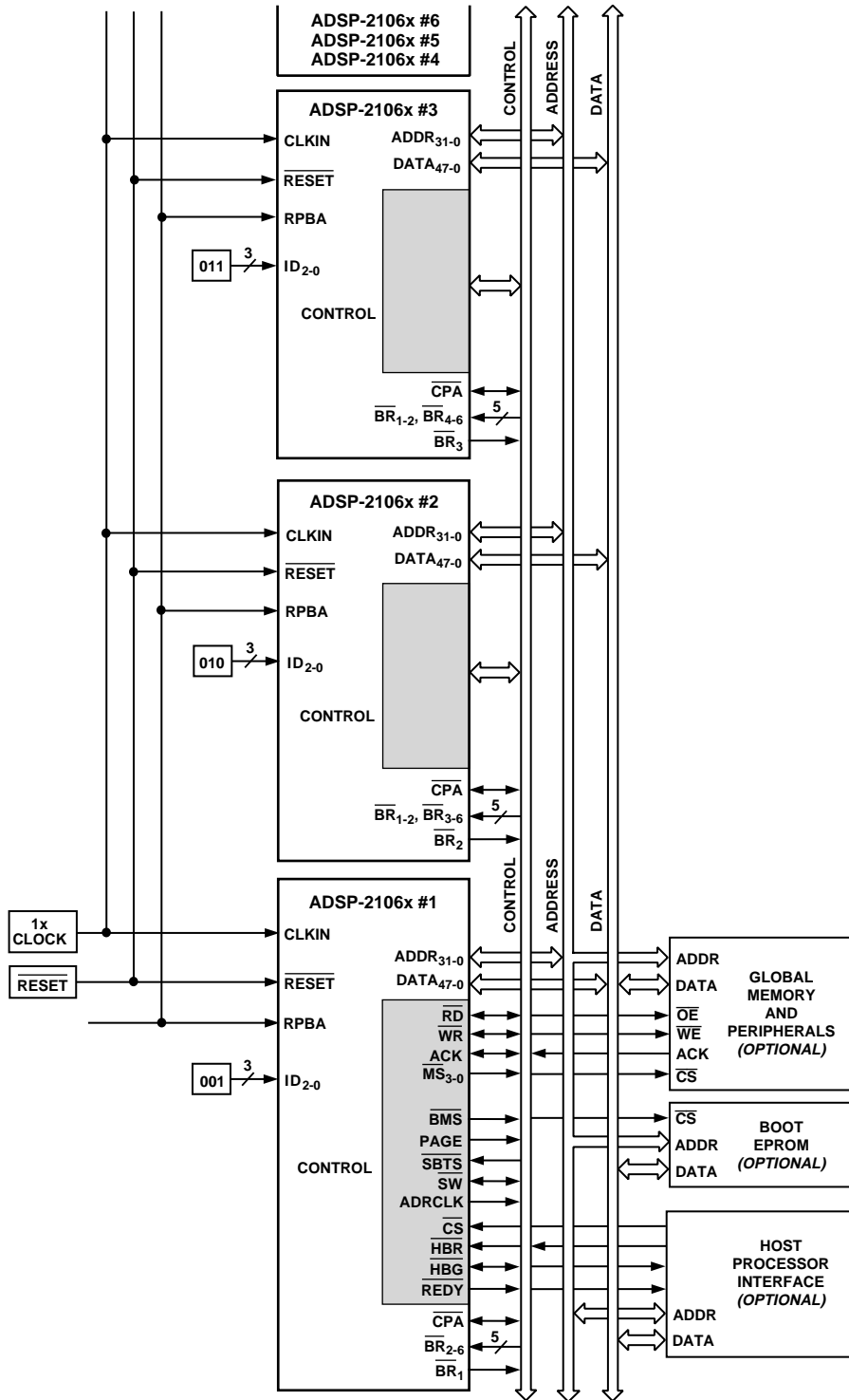

Figure 3. Multiprocessing System

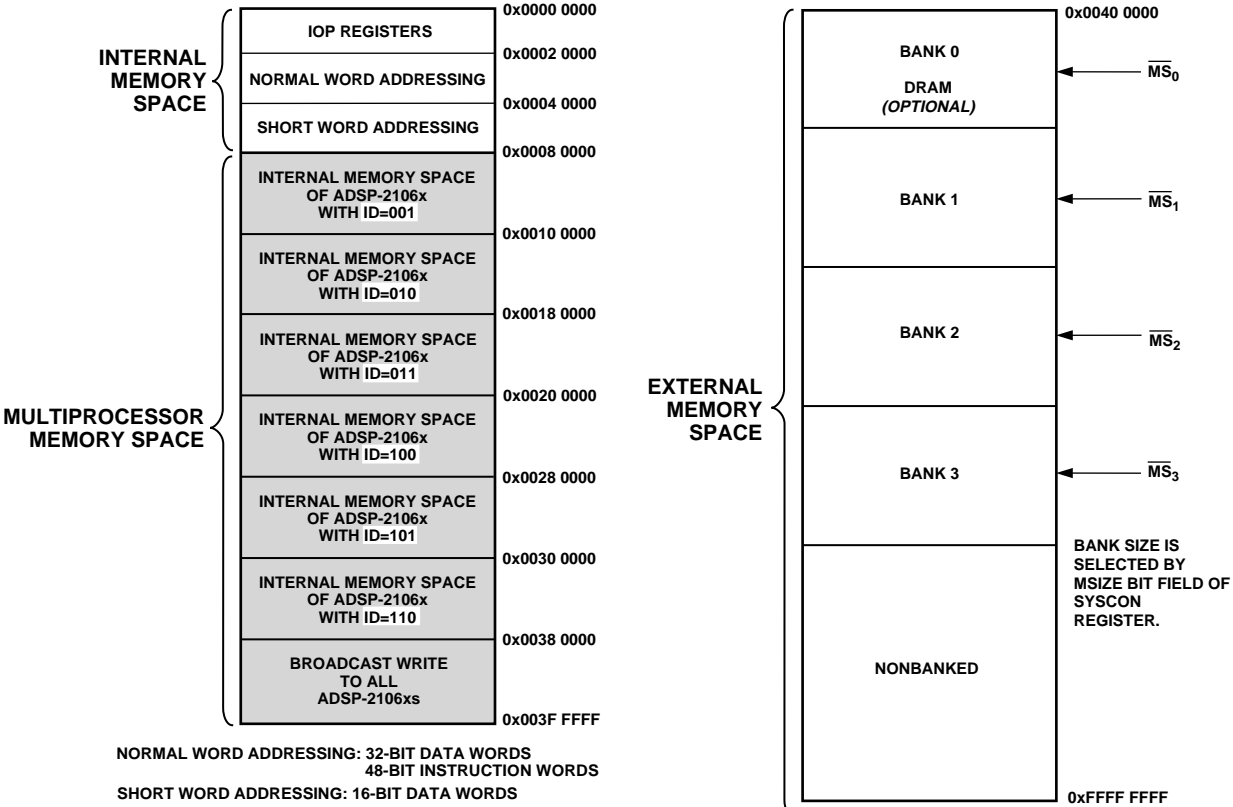

Figure 4. ADSP-21061/ADSP-21061L Memory Map

ADSP-21061/ADSP-21061L

Porting Code from ADSP-21060 or ADSP-21062 to the ADSP-21061

The ADSP-21061 is pin compatible with the ADSP-21060/ADSP-21061/ADSP-21062 processors. The ADSP-21061 pins that correspond to the Link Port pins of the ADSP-21060/ADSP-21062 are no-connects.

The ADSP-21061 is object code compatible with the ADSP-21060/ADSP-21062 except for the following functional changes:

The ADSP-21061 memory is organized into two blocks with eight columns that are 4K deep per block. The ADSP-21060/ADSP-21062 memory has 16 columns per block. Link port functions are not available.

Handshake external port DMA pins $\overline{\text{DMAR2}}$ and $\overline{\text{DMAG2}}$ are assigned to external port DMA Channel 6 instead of Channel 8.

2-D DMA capability of the SPORT is not available.

The modify registers in SPORT DMA are not programmable.

On the ADSP-21061, Block 0 starts at the beginning of internal memory, normal word address 0x0002 0000. Block 1 starts at the end of Block 0, with contiguous addresses. The remaining addresses in internal memory are divided into blocks that alias into Block 1. This allows any code or data stored in Block 1 on the ADSP-21062 to retain the same addresses on the ADSP-21061—these addresses will alias into the actual Block 1 of each processor.

If you develop your application using the ADSP-21062, but will migrate to the ADSP-21061, use only the first eight columns of each memory bank. Limit your application to 8K of instructions or up to 16K of data in each bank of the ADSP-21062, or any combinations of instructions or data that does not exceed the memory bank.

DEVELOPMENT TOOLS

The ADSP-21061 is supported with a complete set of software and hardware development tools, including an EZ-ICE In-Circuit Emulator, EZ-Kit Lite, and development software. The SHARC EZ-Kit Lite (ADDS-2106x-EZ-Lite) is a complete low cost package for DSP evaluation and prototyping. The EZ-Kit Lite contains an evaluation board with an ADSP-21061 (5 V) processor and provides a serial connection to your PC. The EZ-Kit Lite also includes an optimizing compiler, assembler, instruction level simulator, run-time libraries, diagnostic utilities and a complete set of example programs.

The same EZ-ICE hardware can be used for the ADSP-21060/ADSP-21062, to fully emulate the ADSP-21061, with the exception of displaying and modifying the two new SPORTS registers. The emulator will not display these two registers, but your code can use them.

Analog Devices ADSP-21000 Family Development Software includes an easy to use Assembler based on an algebraic syntax, Assembly Library/Librarian, Linker, instruction-level Simulator, an ANSI C optimizing Compiler, the CBug™ C Source—Level Debugger and a C Runtime Library including DSP and mathematical functions. The Optimizing Compiler includes Numerical C extensions based on the work of the ANSI Numerical C Extensions Group. Numerical C provides extensions to the C language for array selections, vector math operations, complex data types, circular pointers and variably dimensioned arrays. The ADSP-21000 Family Development Software is available for both the PC and Sun platforms.

The EZ-ICE Emulator uses the IEEE 1149.1 JTAG test access port of the ADSP-21061 processor to monitor and control the target board processor during emulation. The EZ-ICE provides full-speed emulation, allowing inspection and modification of memory, registers, and processor stacks. Nonintrusive in-circuit emulation is assured by the use of the processor's JTAG interface—the emulator does not affect target system loading or timing.

Further details and ordering information are available in the *ADSP-21000 Family Hardware and Software Development Tools* data sheet (ADDS-210xx-TOOLS). This data sheet can be requested from any Analog Devices sales office or distributor.

In addition to the software and hardware development tools available from Analog Devices, third parties provide a wide range of tools supporting the SHARC processor family. Hardware tools include SHARC PC plug-in cards multiprocessor SHARC VME boards, and daughter and modules with multiple SHARCs and additional memory. These modules are based on the SHARCPAC™ module specification. Third Party software tools include an Ada compiler, DSP libraries, operating systems and block diagram design tools.

ADDITIONAL INFORMATION

This data sheet provides a general overview of the ADSP-21061 architecture and functionality. For detailed information on the ADSP-21000 Family core architecture and instruction set, refer to the *ADSP-2106x SHARC User's Manual, Second Edition*.

ADSP-21061/ADSP-21061L

Pin	Type	Function
$\overline{\text{SBTS}}$	I/S	Suspend Bus Three-State. External devices can assert $\overline{\text{SBTS}}$ (low) to place the external bus address, data, selects, and strobes in a high impedance state for the following cycle. If the ADSP-21061 attempts to access external memory while $\overline{\text{SBTS}}$ is asserted, the processor will halt and the memory access will not be completed until $\overline{\text{SBTS}}$ is deasserted. $\overline{\text{SBTS}}$ should only be used to recover from PAGE faults or host processor/ADSP-21061 deadlock.
$\overline{\text{IRQ}}_{2,0}$	I/A	Interrupt Request Lines. May be either edge-triggered or level-sensitive.
$\overline{\text{FLAG}}_{3,0}$	I/O/A	Flag Pins. Each is configured via control bits as either an input or an output. As an input, it can be tested as a condition. As an output, it can be used to signal external peripherals.
TIMEXP	O	Timer Expired. Asserted for four cycles when the timer is enabled and TCOUNT decrements to zero.
$\overline{\text{HBR}}$	I/A	Host Bus Request. Must be asserted by a host processor to request control of the ADSP-21061's external bus. When $\overline{\text{HBR}}$ is asserted in a multiprocessing system, the ADSP-21061 that is bus master will relinquish the bus and assert $\overline{\text{HBG}}$. To relinquish the bus, the ADSP-21061 places the address, data, select, and strobe lines in a high impedance state. $\overline{\text{HBR}}$ has priority over all ADSP-21061 bus requests ($\overline{\text{BR}}_{6,1}$) in a multiprocessing system.
$\overline{\text{HBG}}$	I/O	Host Bus Grant. Acknowledges an $\overline{\text{HBR}}$ bus request, indicating that the host processor may take control of the external bus. $\overline{\text{HBG}}$ is asserted (held low) by the ADSP-21061 until $\overline{\text{HBR}}$ is released. In a multiprocessing system, $\overline{\text{HBG}}$ is output by the ADSP-21061 bus master and is monitored by all others.
$\overline{\text{CS}}$	I/A	Chip Select. Asserted by host processor to select the ADSP-21061.
REDY (O/D)	O	Host Bus Acknowledge. The ADSP-2106x deasserts REDY (low) to add wait states to an asynchronous access of its internal memory or IOP registers by a host. Open drain output (O/D) by default; can be programmed in ADREDY bit of SYSCON register to be active drive (A/D). REDY will only be output if the $\overline{\text{CS}}$ and $\overline{\text{HBR}}$ inputs are asserted.
$\overline{\text{DMAR}}_1$	I/A	DMA Request 1 (DMA Channel 7).
$\overline{\text{DMAR}}_2$	I/A	DMA Request 2 (DMA Channel 6).
$\overline{\text{DMAG}}_1$	O/T	DMA Grant 1 (DMA Channel 7).
$\overline{\text{DMAG}}_2$	O/T	DMA Grant 2 (DMA Channel 6).
$\overline{\text{BR}}_{6,1}$	I/O/S	Multiprocessing Bus Requests. Used by multiprocessing ADSP-21061s to arbitrate for bus master-ship. An ADSP-21061 only drives its own $\overline{\text{BR}}_x$ line (corresponding to the value of its $\text{ID}_{2,0}$ inputs) and monitors all others. In a multiprocessor system with less than six ADSP-21061s, the unused $\overline{\text{BR}}_x$ pins should be tied high; the processor's own $\overline{\text{BR}}_x$ line must not be tied high or low because it is an output.
$\text{ID}_{2,0}$	I	Multiprocessing ID. Determines which multiprocessing bus request ($\overline{\text{BR}}_1$ – $\overline{\text{BR}}_6$) is used by ADSP-21061. ID = 001 corresponds to $\overline{\text{BR}}_1$, ID = 010 corresponds to $\overline{\text{BR}}_2$, etc. ID = 000 in single-processor systems. These lines are a system configuration selection which should be hardwired or only changed at reset.
RPBA	I/S	Rotating Priority Bus Arbitration Select. When RPBA is high, rotating priority for multiprocessor bus arbitration is selected. When RPBA is low, fixed priority is selected. This signal is a system configuration selection which must be set to the same value on every ADSP-21061. If the value of RPBA is changed during system operation, it must be changed in the same CLKIN cycle on every ADSP-21061.
$\overline{\text{CPA}}$ (O/D)	I/O	Core Priority Access. Asserting its $\overline{\text{CPA}}$ pin allows the core processor of an ADSP-21061 bus slave to interrupt background DMA transfers and gain access to the external bus. $\overline{\text{CPA}}$ is an open drain output that is connected to all ADSP-21061s in the system. The $\overline{\text{CPA}}$ pin has an internal 5 k Ω pull-up resistor. If core access priority is not required in a system, the $\overline{\text{CPA}}$ pin should be left unconnected.
DTx	O	Data Transmit (Serial Ports 0, 1). Each DT pin has a 50 k Ω internal pull-up resistor.
DRx	I	Data Receive (Serial Ports 0, 1). Each DR pin has a 50 k Ω internal pull-up resistor.
TCLKx	I/O	Transmit Clock (Serial Ports 0, 1). Each TCLK pin has a 50 k Ω internal pull-up resistor.
RCLKx	I/O	Receive Clock (Serial Ports 0, 1). Each RCLK pin has a 50 k Ω internal pull-up resistor.

Pin	Type	Function																
TFSx	I/O	Transmit Frame Sync (Serial Ports 0, 1).																
RFSx	I/O	Receive Frame Sync (Serial Ports 0, 1).																
EBOOT	I	EPROM Boot Select. When EBOOT is high, the ADSP-21061 is configured for booting from an 8-bit EPROM. When EBOOT is low, the LBOOT and $\overline{\text{BMS}}$ inputs determine booting mode. See table below. This signal is a system configuration selection which should be hardwired.																
LBOOT	I	Link Boot—Must be tied to GND.																
$\overline{\text{BMS}}$	I/O/T*	<p>Boot Memory Select. <i>Output:</i> Used as chip select for boot EPROM devices (when EBOOT = 1, LBOOT = 0). In a multiprocessor system, $\overline{\text{BMS}}$ is output by the bus master. <i>Input:</i> When low, indicates that no booting will occur and that ADSP-21061 will begin executing instructions from external memory. See table below. This input is a system configuration selection which should be hardwired.</p> <p>*Three-statable only in EPROM boot mode (when $\overline{\text{BMS}}$ is an output).</p> <table border="1"> <thead> <tr> <th><i>EBOOT</i></th> <th><i>LBOOT</i></th> <th>$\overline{\text{BMS}}$</th> <th><i>Booting Mode</i></th> </tr> </thead> <tbody> <tr> <td>1</td> <td>0</td> <td>Output</td> <td>EPROM (Connect $\overline{\text{BMS}}$ to EPROM chip select.)</td> </tr> <tr> <td>0</td> <td>0</td> <td>1 (Input)</td> <td>Host Processor</td> </tr> <tr> <td>0</td> <td>0</td> <td>0 (Input)</td> <td>No Booting. Processor executes from external memory.</td> </tr> </tbody> </table>	<i>EBOOT</i>	<i>LBOOT</i>	$\overline{\text{BMS}}$	<i>Booting Mode</i>	1	0	Output	EPROM (Connect $\overline{\text{BMS}}$ to EPROM chip select.)	0	0	1 (Input)	Host Processor	0	0	0 (Input)	No Booting. Processor executes from external memory.
<i>EBOOT</i>	<i>LBOOT</i>	$\overline{\text{BMS}}$	<i>Booting Mode</i>															
1	0	Output	EPROM (Connect $\overline{\text{BMS}}$ to EPROM chip select.)															
0	0	1 (Input)	Host Processor															
0	0	0 (Input)	No Booting. Processor executes from external memory.															
CLKIN	I	Clock In. External clock input to the ADSP-21061. The instruction cycle rate is equal to CLKIN. CLKIN may not be halted, changed, or operated below the specified frequency.																
$\overline{\text{RESET}}$	I/A	Processor Reset. Resets the ADSP-21061 to a known state and begins execution at the program memory location specified by the hardware reset vector address. This input must be asserted (low) at power-up.																
TCK	I	Test Clock (JTAG). Provides an asynchronous clock for JTAG boundary scan.																
TMS	I/S	Test Mode Select (JTAG). Used to control the test state machine. TMS has a 20 k Ω internal pull-up resistor.																
TDI	I/S	Test Data Input (JTAG). Provides serial data for the boundary scan logic. TDI has a 20 k Ω internal pull-up resistor.																
TDO	O	Test Data Output (JTAG). Serial scan output of the boundary scan path.																
$\overline{\text{TRST}}$	I/A	Test Reset (JTAG). Resets the test state machine. $\overline{\text{TRST}}$ must be asserted (pulsed low) after power-up or held low for proper operation of the ADSP-21061. $\overline{\text{TRST}}$ has a 20 k Ω internal pull-up resistor.																
$\overline{\text{EMU}}$	O	Emulation Status. Must be connected to the ADSP-21061 EZ-ICE target board connector <i>only</i> .																
ICSA	O	Reserved, leave unconnected.																
VDD	P	Power Supply; nominally +3.3 V dc. (30 Pins)																
GND	G	Power Supply Return. (30 Pins)																
NC		Do Not Connect. Reserved pins which must be left open and unconnected.																

ADSP-21061/ADSP-21061L

TARGET BOARD CONNECTOR FOR EZ-ICE PROBE

The ADSP-2106x EZ-ICE Emulator uses the IEEE 1149.1 JTAG test access port of the ADSP-2106x to monitor and control the target board processor during emulation. The EZ-ICE probe requires the ADSP-2106x's CLKIN, TMS, TCK, $\overline{\text{TRST}}$, TDI, TDO, $\overline{\text{EMU}}$, and GND signals be made accessible on the target system via a 14-pin connector (a 2 row \times 7 pin strip header) such as that shown in Figure 5. The EZ-ICE probe plugs directly onto this connector for chip-on-board emulation. You must add this connector to your target board design if you intend to use the ADSP-2106x EZ-ICE. The total trace length between the EZ-ICE connector and the furthest device sharing the EZ-ICE JTAG pins should be limited to 15 inches maximum for guaranteed operation. This length restriction must include EZ-ICE JTAG signals that are routed to one or more ADSP-2106x devices, or a combination of ADSP-2106x devices and other JTAG devices on the chain.

The 14-pin, 2-row pin strip header is keyed at the Pin 3 location — Pin 3 must be removed from the header. The pins must be 0.025 inch square and at least 0.20 inch in length. Pin spacing should be 0.1 \times 0.1 inches. Pin strip headers are available from vendors such as 3M, McKenzie and Samtec.

The BTMS, BTCK, $\overline{\text{BTRST}}$ and BTDI signals are provided so the test access port can also be used for board-level testing. When the connector is not being used for emulation, place jumpers between the Bxxx pins and the xxx pins. If the test access port will not be used for board testing, tie $\overline{\text{BTRST}}$ to GND and tie or pull BTCK up to VDD. The $\overline{\text{TRST}}$ pin must be asserted after power-up (through $\overline{\text{BTRST}}$ on the connector) or held low for proper operation of the ADSP-2106x. None of the Bxxx pins (Pins 5, 7, 9, 11) are connected on the EZ-ICE probe.

The JTAG signals are terminated on the EZ-ICE probe as follows:

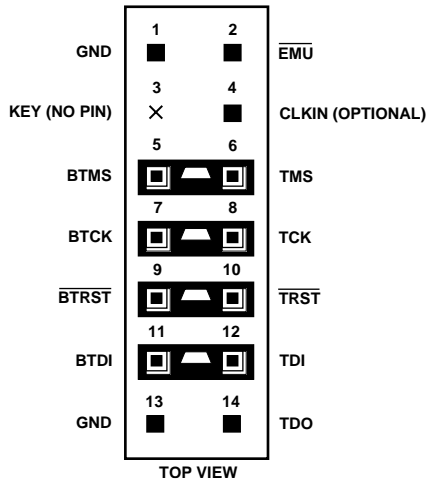

Signal	Termination
TMS	Driven through 22 Ω Resistor (16 mA Driver)
TCK	Driven at 10 MHz through 22 Ω Resistor (16 mA Driver)
$\overline{\text{TRST}}^*$	Active Low Driven through 22 Ω Resistor (16 mA Driver) (Pulled Up by On-Chip 20 k Ω Resistor)
TDI	Driven by 22 Ω Resistor (16 mA Driver)
TDO	One TTL Load, Split Termination (160/220)
CLKIN	One TTL Load, Split Termination (160/220)
$\overline{\text{EMU}}$	Active Low 4.7 k Ω Pull-Up Resistor, One TTL Load (Open-Drain Output from the DSP)

* $\overline{\text{TRST}}$ is driven low until the EZ-ICE probe is turned on by the emulator at software start-up. After software start-up, $\overline{\text{TRST}}$ is driven high.

Figure 6 shows JTAG scan path connections for systems that contain multiple ADSP-2106x processors.

Figure 5. Target Board Connector For ADSP-21061/ADSP-21061L EZ-ICE Emulator (Jumpers in Place)

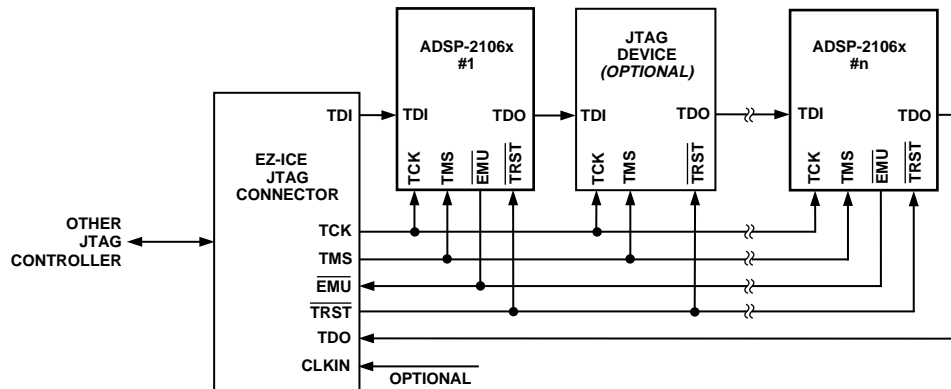

Figure 6. JTAG Scan Path Connections for Multiple ADSP-21061/ADSP-21061L Systems

ADSP-21061/ADSP-21061L

ADSP-21061–SPECIFICATIONS

RECOMMENDED OPERATING CONDITIONS (5 V)

Parameter	Test Conditions	K Grade		Units	
		Min	Max		
V _{DD}	Supply Voltage	4.75	5.25	V	
T _{CASE}	Case Operating Temperature	0	+85	°C	
V _{IH1}	High Level Input Voltage ¹	@ V _{DD} = max	2.0	V _{DD} + 0.5	V
V _{IH2}	High Level Input Voltage ²	@ V _{DD} = max	2.2	V _{DD} + 0.5	V
V _{IL}	Low Level Input Voltage ^{1, 2}	@ V _{DD} = min	-0.5	0.8	V

NOTES

¹Applies to input and bidirectional pins: DATA₄₇₋₀, ADDR₃₁₋₀, \overline{RD} , \overline{WR} , \overline{SW} , ACK, \overline{SBTS} , \overline{IRQ}_{2-0} , FLAG₃₋₀, \overline{HBG} , \overline{CS} , $\overline{DMAR1}$, $\overline{DMAR2}$, \overline{BR}_{6-1} , ID₂₋₀, RPBA, CPA, TFS0, TFS1, RFS0, RFS1, LxDAT₃₋₀, LxCLK, LxACK, EBOOT, LBOOT, \overline{BMS} , TMS, TDI, TCK, \overline{HBR} , DR0, DR1, TCLK0, TCLK1, RCLK0, RCLK1.

²Applies to input pins: CLKIN, \overline{RESET} , \overline{TRST} .

ELECTRICAL CHARACTERISTICS (5 V)

Parameter	Test Conditions	Min	Max	Units
V _{OH}	High Level Output Voltage ¹	@ V _{DD} = min, I _{OH} = -2.0 mA ²	4.1	V
V _{OL}	Low Level Output Voltage ¹	@ V _{DD} = min, I _{OL} = 4.0 mA ²	0.4	V
I _{IH}	High Level Input Current ^{3, 4}	@ V _{DD} = max, V _{IN} = V _{DD} max	10	μA
I _{IL}	Low Level Input Current ³	@ V _{DD} = max, V _{IN} = 0 V	10	μA
I _{ILP}	Low Level Input Current ⁴	@ V _{DD} = max, V _{IN} = 0 V	150	μA
I _{OZH}	Three-State Leakage Current ^{5, 6, 7, 8}	@ V _{DD} = max, V _{IN} = V _{DD} max	10	μA
I _{OZL}	Three-State Leakage Current ^{5, 9}	@ V _{DD} = max, V _{IN} = 0 V	10	μA
I _{OZHP}	Three-State Leakage Current ⁹	@ V _{DD} = max, V _{IN} = V _{DD} max	350	μA
I _{OZLC}	Three-State Leakage Current ⁷	@ V _{DD} = max, V _{IN} = 0 V	1.5	mA
I _{OZLA}	Three-State Leakage Current ¹⁰	@ V _{DD} = max, V _{IN} = 0 V	350	μA
I _{OZLAR}	Three-State Leakage Current ⁸	@ V _{DD} = max, V _{IN} = 1.5 V	4.2	mA
I _{OZLS}	Three-State Leakage Current ⁶	@ V _{DD} = max, V _{IN} = 0 V	150	mA
C _{IN}	Input Capacitance ^{11, 12}	f _{IN} = 1 MHz, T _{CASE} = 25°C, V _{IN} = 2.5 V	4.7	pF

NOTES

¹Applies to output and bidirectional pins: DATA₄₇₋₀, ADDR₃₁₋₀, \overline{MS}_{3-0} , \overline{RD} , \overline{WR} , PAGE, ADRCLK, \overline{SW} , ACK, FLAG₃₋₀, TIMEXP, \overline{HBG} , REDY, $\overline{DMAG1}$, $\overline{DMAG2}$, \overline{BR}_{6-1} , CPA, DT0, DT1, TCLK0, TCLK1, RCLK0, RCLK1, TFS0, TFS1, RFS0, RFS1, LxDAT₃₋₀, LxCLK, LxACK, \overline{BMS} , TDO, \overline{EMU} , ICSA.

²See Output Drive Currents section for typical drive current capabilities.

³Applies to input pins: ACK, \overline{SBTS} , \overline{IRQ}_{2-0} , \overline{HBR} , \overline{CS} , $\overline{DMAR1}$, $\overline{DMAR2}$, ID₂₋₀, RPBA, EBOOT, LBOOT, CLKIN, \overline{RESET} , TCK. Note that ACK is pulled up internally with 2 kΩ during reset in a multiprocessor system, when ID₂₋₀ = 001 and another ADSP-2106x is not requesting bus mastership.)

⁴Applies to input pins with internal pull-ups: DR0, DR1, \overline{TRST} , TMS, TDI.

⁵Applies to three-statable pins: DATA₄₇₋₀, ADDR₃₁₋₀, \overline{MS}_{3-0} , \overline{RD} , \overline{WR} , PAGE, ADRCLK, \overline{SW} , ACK, FLAG₃₋₀, REDY, \overline{HBG} , $\overline{DMAG1}$, $\overline{DMAG2}$, \overline{BMS} , \overline{BR}_{6-1} , TFS_x, RFS_x, TDO, \overline{EMU} . (Note that ACK is pulled up internally with 2 kΩ during reset in a multiprocessor system, when ID₂₋₀ = 001 and another ADSP-2106x is not requesting bus mastership.)

⁶Applies to three-statable pins with internal pull-ups: DT0, DT1, TCLK0, TCLK1, RCLK0, RCLK1.

⁷Applies to CPA pin.

⁸Applies to ACK pin when pulled up. (Note that ACK is pulled up internally with 2 kΩ during reset in a multiprocessor system, when ID₂₋₀ = 001 and another ADSP-21061x is not requesting bus mastership.)

⁹Applies to three-statable pins with internal pull-downs: LxDAT₃₋₀, LxCLK, LxACK.

¹⁰Applies to ACK pin when keeper latch enabled.

¹¹Applies to all signal pins.

¹²Guaranteed but not tested.

Specifications subject to change without notice.

POWER DISSIPATION ADSP-21061 (5 V)

These specifications apply to the internal power portion of V_{DD} only. See the Power Dissipation section of this data sheet for calculation of external supply current and total supply current. For a complete discussion of the code used to measure power dissipation, see the technical note “SHARC Power Dissipation Measurements.”

Specifications are based on the following operating scenarios:

Operation	Peak Activity ($I_{DDINPEAK}$)	High Activity ($I_{DDINHIGH}$)	Low Activity ($I_{DDINLOW}$)
Instruction Type	Multifunction	Multifunction	Single Function
Instruction Fetch	Cache	Internal Memory	Internal Memory
Core Memory Access	2 per Cycle (DM and PM)	1 per Cycle (DM)	None
Internal Memory DMA	1 per Cycle	1 per 2 Cycles	1 per 2 Cycles

To estimate power consumption for a specific application, use the following equation where % is the amount of time your program spends in that state:

$$\%PEAK \times I_{DDINPEAK} + \%HIGH \times I_{DDINHIGH} + \%LOW \times I_{DDINLOW} + \%IDLE \times I_{DDIDLE} + \%IDLE16 \times I_{DDIDLE16} = \text{power consumption}$$

Parameter	Test Conditions	Max	Units
$I_{DDINPEAK}$ Supply Current (Internal) ¹	$t_{CK} = 30 \text{ ns}, V_{DD} = \text{max},$	595	mA
	$t_{CK} = 25 \text{ ns}, V_{DD} = \text{max},$	680	mA
	$t_{CK} = 20 \text{ ns}, V_{DD} = \text{max},$	850	mA
$I_{DDINHIGH}$ Supply Current (Internal) ²	$t_{CK} = 30 \text{ ns}, V_{DD} = \text{max},$	460	mA
	$t_{CK} = 25 \text{ ns}, V_{DD} = \text{max},$	540	mA
	$t_{CK} = 20 \text{ ns}, V_{DD} = \text{max},$	670	mA
$I_{DDINLOW}$ Supply Current (Internal) ³	$t_{CK} = 30 \text{ ns}, V_{DD} = \text{max},$	270	mA
	$t_{CK} = 25 \text{ ns}, V_{DD} = \text{max},$	320	mA
	$t_{CK} = 20 \text{ ns}, V_{DD} = \text{max},$	390	mA
I_{DDIDLE} Supply Current (Idle) ⁴	$V_{DD} = \text{max}$	200	mA
$I_{DDIDLE16}$ Supply Current (Idle16) ⁵	$V_{DD} = \text{max}$	55	mA

NOTES

¹The test program used to measure $I_{DDINPEAK}$ represents worst case processor operation and is not sustainable under normal application conditions. Actual internal power measurements made using typical applications are less than specified.

² $I_{DDINHIGH}$ is a composite average based on a range of high activity code.

³ $I_{DDINLOW}$ is a composite average based on a range of low activity code.

⁴Idle denotes ADSP-21061 state during execution of IDLE instruction.

⁵Idle16 denotes ADSP-21061 state during execution of IDLE16 instruction.

ADSP-21061/ADSP-21061L

ADSP-21061L—SPECIFICATIONS

RECOMMENDED OPERATING CONDITIONS (3.3 V)

Parameter	Test Conditions	K Grade		Units	
		Min	Max		
V _{DD}	Supply Voltage	3.15	3.45	V	
T _{CASE}	Case Operating Temperature	0	+85	°C	
V _{IH1}	High Level Input Voltage ¹	@ V _{DD} = max	2.0	V _{DD} + 0.5	V
V _{IH2}	High Level Input Voltage ²	@ V _{DD} = max	2.2	V _{DD} + 0.5	V
V _{IL}	Low Level Input Voltage ^{1, 2}	@ V _{DD} = min	-0.5	0.8	V

NOTES

¹Applies to input and bidirectional pins: DATA₄₇₋₀, ADDR₃₁₋₀, \overline{RD} , \overline{WR} , \overline{SW} , ACK, \overline{SBTS} , \overline{IRQ}_{2-0} , FLAG₃₋₀, \overline{HBG} , \overline{CS} , $\overline{DMAR1}$, $\overline{DMAR2}$, \overline{BR}_{6-1} , ID₂₋₀, RPBA, CPA, TFS0, TFS1, RFS0, RFS1, LxDAT₃₋₀, LxCLK, LxACK, EBOOT, LBOOT, \overline{BMS} , TMS, TDI, TCK, \overline{HBR} , DR0, DR1, TCLK0, TCLK1, RCLK0, RCLK1.

²Applies to input pins: CLKIN, RESET, TRST.

ELECTRICAL CHARACTERISTICS (3.3 V)

Parameter	Test Conditions	Min	Max	Units
V _{OH}	High Level Output Voltage ¹	@ V _{DD} = min, I _{OH} = -2.0 mA ²	2.4	V
V _{OL}	Low Level Output Voltage ¹	@ V _{DD} = min, I _{OL} = 4.0 mA ²	0.4	V
I _{IH}	High Level Input Current ^{3, 4}	@ V _{DD} = max, V _{IN} = V _{DD} max	10	μA
I _{IL}	Low Level Input Current ³	@ V _{DD} = max, V _{IN} = 0 V	10	μA
I _{ILP}	Low Level Input Current ⁴	@ V _{DD} = max, V _{IN} = 0 V	150	μA
I _{OZH}	Three-State Leakage Current ^{5, 6, 7, 8}	@ V _{DD} = max, V _{IN} = V _{DD} max	10	μA
I _{OZL}	Three-State Leakage Current ^{5, 9}	@ V _{DD} = max, V _{IN} = 0 V	10	μA
I _{OZHP}	Three-State Leakage Current ⁹	@ V _{DD} = max, V _{IN} = V _{DD} max	350	μA
I _{OZLC}	Three-State Leakage Current ⁷	@ V _{DD} = max, V _{IN} = 0 V	1.5	mA
I _{OZLA}	Three-State Leakage Current ¹⁰	@ V _{DD} = max, V _{IN} = 0 V	350	μA
I _{OZLAR}	Three-State Leakage Current ⁸	@ V _{DD} = max, V _{IN} = 2.0 V	4.2	mA
I _{OZLS}	Three-State Leakage Current ⁶	@ V _{DD} = max, V _{IN} = 0 V	150	mA
C _{IN}	Input Capacitance ^{11, 12}	f _{IN} = 1 MHz, T _{CASE} = 25°C, V _{IN} = 2.5 V	4.7	pF

NOTES

¹Applies to output and bidirectional pins: DATA₄₇₋₀, ADDR₃₁₋₀, \overline{MS}_{3-0} , \overline{RD} , \overline{WR} , PAGE, ADRCLK, \overline{SW} , ACK, FLAG₃₋₀, TIMEXP, \overline{HBG} , REDI, $\overline{DMAG1}$, $\overline{DMAG2}$, \overline{BR}_{6-1} , CPA, DT0, DT1, TCLK0, TCLK1, RCLK0, RCLK1, TFS0, TFS1, RFS0, RFS1, LxDAT₃₋₀, LxCLK, LxACK, \overline{BMS} , TDO, EMU, ICSA.

²See “Output Drive Currents” for typical drive current capabilities.

³Applies to input pins: ACK, \overline{SBTS} , \overline{IRQ}_{2-0} , \overline{HBR} , \overline{CS} , $\overline{DMAR1}$, $\overline{DMAR2}$, ID₂₋₀, RPBA, EBOOT, LBOOT, CLKIN, RESET, TCK. Note that ACK is pulled up internally with 2 kΩ during reset in a multiprocessor system, when ID₂₋₀ = 001 and another ADSP-2106x is not requesting bus mastership.)

⁴Applies to input pins with internal pull-ups: DR0, DR1, TRST, TMS, TDI.

⁵Applies to three-statable pins: DATA₄₇₋₀, ADDR₃₁₋₀, \overline{MS}_{3-0} , \overline{RD} , \overline{WR} , PAGE, ADRCLK, \overline{SW} , ACK, FLAG₃₋₀, REDI, \overline{HBG} , $\overline{DMAG1}$, $\overline{DMAG2}$, \overline{BMS} , \overline{BR}_{6-1} , TFS_x, RFS_x, TDO, EMU. (Note that ACK is pulled up internally with 2 kΩ during reset in a multiprocessor system, when ID₂₋₀ = 001 and another ADSP-2106x is not requesting bus mastership.)

⁶Applies to three-statable pins with internal pull-ups: DT0, DT1, TCLK0, TCLK1, RCLK0, RCLK1.

⁷Applies to CPA pin.

⁸Applies to ACK pin when pulled up. (Note that ACK is pulled up internally with 2 kΩ during reset in a multiprocessor system, when ID₂₋₀ = 001 and another ADSP-21061L is not requesting bus mastership.)

⁹Applies to three-statable pins with internal pull-downs: LxDAT₃₋₀, LxCLK, LxACK.

¹⁰Applies to ACK pin when keeper latch enabled.

¹¹Applies to all signal pins.

¹²Guaranteed but not tested.

Specifications subject to change without notice.

POWER DISSIPATION ADSP-21061L (3.3 V)

These specifications apply to the internal power portion of V_{DD} only. See the Power Dissipation section of this data sheet for calculation of external supply current and total supply current. For a complete discussion of the code used to measure power dissipation, see the technical note "SHARC Power Dissipation Measurements."

Specifications are based on the following operating scenarios:

Operation	Peak Activity ($I_{DDINPEAK}$)	High Activity ($I_{DDINHIGH}$)	Low Activity ($I_{DDINLOW}$)
Instruction Type	Multifunction	Multifunction	Single Function
Instruction Fetch	Cache	Internal Memory	Internal Memory
Core Memory Access	2 per Cycle (DM and PM)	1 per Cycle (DM)	None
Internal Memory DMA	1 per Cycle	1 per 2 Cycles	1 per 2 Cycles

To estimate power consumption for a specific application, use the following equation where % is the amount of time your program spends in that state:

$$\%PEAK \times I_{DDINPEAK} + \%HIGH \times I_{DDINHIGH} + \%LOW \times I_{DDINLOW} + \%IDLE \times I_{DDIDLE} + \%IDLE16 \times I_{DDIDLE16} = \text{power consumption}$$

Parameter	Test Conditions	Max	Units
$I_{DDINPEAK}$ Supply Current (Internal) ¹	$t_{CK} = 25 \text{ ns}, V_{DD} = \text{max},$ $t_{CK} = 22.5 \text{ ns}, V_{DD} = \text{max},$	480 535	mA mA
$I_{DDINHIGH}$ Supply Current (Internal) ²	$t_{CK} = 25 \text{ ns}, V_{DD} = \text{max},$ $t_{CK} = 22.5 \text{ ns}, V_{DD} = \text{max},$	380 425	mA mA
$I_{DDINLOW}$ Supply Current (Internal) ³	$t_{CK} = 25 \text{ ns}, V_{DD} = \text{max},$ $t_{CK} = 22.5 \text{ ns}, V_{DD} = \text{max},$	220 245	mA mA
I_{DDIDLE} Supply Current (Idle) ⁴	$V_{DD} = \text{max}$	180	mA
$I_{DDIDLE16}$ Supply Current (Idle16) ⁵	$V_{DD} = \text{max}$	50	mA

NOTES

¹The test program used to measure $I_{DDINPEAK}$ represents worst case processor operation and is not sustainable under normal application conditions. Actual internal power measurements made using typical applications are less than specified.

² $I_{DDINHIGH}$ is a composite average based on a range of high activity code.

³ $I_{DDINLOW}$ is a composite average based on a range of low activity code.

⁴Idle denotes ADSP-21061L state during execution of IDLE instruction.

⁵Idle16 denotes ADSP-21061L state during execution of IDLE16 instruction.

ADSP-21061/ADSP-21061L

ABSOLUTE MAXIMUM RATINGS (5 V DEVICE)*

Supply Voltage	-0.3 V to +7 V
Input Voltage	-0.5 V to $V_{DD} + 0.5$ V
Output Voltage Swing	-0.5 V to $V_{DD} + 0.5$ V
Load Capacitance	200 pF
Junction Temperature Under Bias	130°C
Storage Temperature Range	-65°C to +150°C
Lead Temperature (5 seconds)	+280°C

*Stresses greater than those listed above may cause permanent damage to the device. These are stress ratings only; functional operation of the device at these or any other conditions greater than those indicated in the operational sections of this specification is not implied. Exposure to absolute maximum rating conditions for extended periods may affect device reliability.

ABSOLUTE MAXIMUM RATINGS (3.3 V DEVICE)*

Supply Voltage	-0.3 V to +4.6 V
Input Voltage	-0.5 V to $V_{DD} + 0.5$ V
Output Voltage Swing	-0.5 V to $V_{DD} + 0.5$ V
Load Capacitance	200 pF
Junction Temperature Under Bias	130°C
Storage Temperature Range	-65°C to +150°C
Lead Temperature (5 seconds)	+280°C

*Stresses greater than those listed above may cause permanent damage to the device. These are stress ratings only; functional operation of the device at these or any other conditions greater than those indicated in the operational sections of this specification is not implied. Exposure to absolute maximum rating conditions for extended periods may affect device reliability.

ESD SENSITIVITY

The ADSP-2106x processors are ESD (electrostatic discharge) sensitive devices. Electrostatic charges readily accumulate on the human body and equipment and can discharge without detection. Permanent damage may occur to devices subjected to high energy electrostatic discharges.

The ADSP-2106x processors include proprietary ESD protection circuitry to dissipate high energy discharges. Per method 3015 of MIL-STD-883, the ADSP-2106x processors have been classified as a Class 2 device.

Proper ESD precautions are recommended to avoid performance degradation or loss of functionality. Unused devices must be stored in conductive foam or shunts, and the foam should be discharged to the destination socket before devices are removed.



TIMING SPECIFICATIONS

GENERAL NOTES

The following timing specifications are target specifications and are based on device simulation only.

The timing specifications shown are based on a CLKIN frequency of 40 MHz ($t_{CK} = 25$ ns). The DT derating allows specifications at other CLKIN frequencies (within the min-max range of the t_{CK} specification; see Clock Input below). DT is the difference between the actual CLKIN period and a CLKIN period of 25 ns:

$$DT = t_{CK} - 25 \text{ ns}$$

Use the exact timing information given. Do not attempt to derive parameters from the addition or subtraction of others. While addition or subtraction would yield meaningful results for an individual device, the values given in this data sheet reflect statistical variations and worst cases. Consequently, you cannot meaningfully add parameters to derive longer times.

See Figure 26 under Test Conditions for voltage reference levels.

Switching Characteristics specify how the processor changes its signals. You have no control over this timing—circuitry external to the processor must be designed for compatibility with these signal characteristics. Switching characteristics tell you what the processor will do in a given circumstance. You can also use switching characteristics to ensure that any timing requirement of a device connected to the processor (such as memory) is satisfied.

Timing Requirements apply to signals that are controlled by circuitry external to the processor, such as the data input for a read operation. Timing requirements guarantee that the processor operates correctly with other devices.

(O/D) = Open Drain

(A/D) = Active Drive

ADSP-21061/ADSP-21061L

Parameter		ADSP-21061 (5 V)						Units
		33 MHz		40 MHz		50 MHz		
		Min	Max	Min	Max	Min	Max	
Clock Input								
<i>Timing Requirements:</i>								
t_{CK}	CLKIN Period	30	100	25	100	20	100	ns
t_{CKL}	CLKIN Width Low	7		7		7		ns
t_{CKH}	CLKIN Width High	5		5		5		ns
t_{CKRF}	CLKIN Rise/Fall (0.4 V–2.0 V)		3		3		3	ns

Parameter		ADSP-21061L (3.3 V)				Units
		40 MHz		44 MHz		
		Min	Max	Min	Max	
Clock Input						
<i>Timing Requirements:</i>						
t_{CK}	CLKIN Period	25	100	22.5	100	ns
t_{CKL}	CLKIN Width Low	7		7		ns
t_{CKH}	CLKIN Width High	5		5		ns
t_{CKRF}	CLKIN Rise/Fall (0.4 V–2.0 V)		3		3	ns

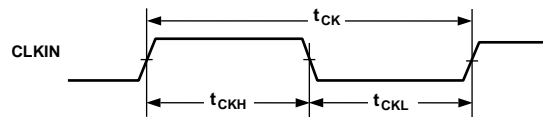

Figure 8. Clock Input

Parameter		ADSP-21061 (5 V)		ADSP-21061L (3.3 V)		Units
		Min	Max	Min	Max	
Reset						
<i>Timing Requirements:</i>						
t_{WRST}	\overline{RESET} Pulsewidth Low ¹	$4t_{CK}$		$4t_{CK}$		ns
t_{SRST}	\overline{RESET} Setup before CLKIN High ²	$14 + DT/2$	t_{CK}	$14 + DT/2$	t_{CK}	ns

NOTES

¹Applies after the power-up sequence is complete. At power-up, the processor's internal phase-locked loop requires no more than 2000 CLKIN cycles while RESET is low, assuming stable V_{DD} and CLKIN (not including start-up time of external clock oscillator).

²Only required if multiple ADSP-2106xs must come out of reset synchronous to CLKIN with program counters (PC) equal (i.e., for a SIMD system). Not required for multiple ADSP-2106xs communicating over the shared bus (through the external port), because the bus arbitration logic automatically synchronizes itself after reset.

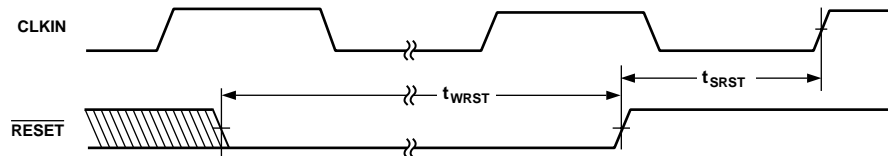

Figure 9. Reset

Parameter		ADSP-21061 (5 V)		ADSP-21061L (3.3 V)		Units
		Min	Max	Min	Max	
Interrupts						
<i>Timing Requirements:</i>						
t_{SIR}	$\overline{IRQ2-0}$ Setup before CLKIN High ¹	$18 + 3DT/4$		$18 + 3DT/4$		ns
t_{HIR}	$\overline{IRQ2-0}$ Hold before CLKIN High ¹		$12 + 3DT/4$		$12 + 3DT/4$	ns
t_{IPW}	$\overline{IRQ2-0}$ Pulsewidth ²	$2 + t_{CK}$		$2 + t_{CK}$		ns

NOTES

¹Only required for \overline{IRQx} recognition in the following cycle.

²Applies only if t_{SIR} and t_{HIR} requirements are not met.

ADSP-21061/ADSP-21061L

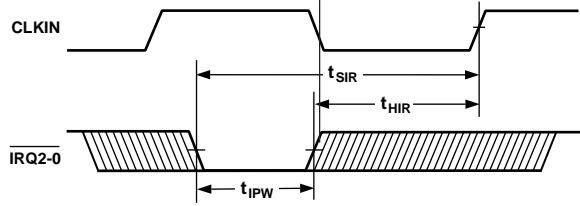

Figure 10. Interrupts

Parameter	ADSP-21061 (5 V)		ADSP-21061L (3.3 V)		Units
	Min	Max	Min	Max	
Timer					
<i>Switching Characteristics:</i>					
t_{DTEX} CLKIN High to TIMEXP		15		15	ns

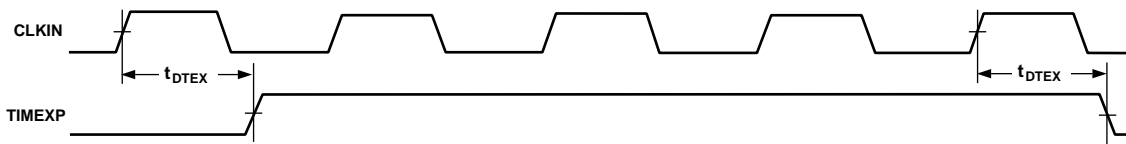

Figure 11. Timer

Parameter	ADSP-21061 (5 V)		ADSP-21061L (3.3 V)		Units
	Min	Max	Min	Max	
<i>Timing Requirements:</i>					
t_{SFI} FLAG3-0 _{IN} Setup before CLKIN High ¹	8 + 5DT/16		8 + 5DT/16		ns
t_{HFI} FLAG3-0 _{IN} Hold after CLKIN High ¹	0 - 5DT/16		0 - 5DT/16		ns
t_{DWRFI} FLAG3-0 _{IN} Delay after $\overline{RD}/\overline{WR}$ Low ¹		5 + 7DT/16		5 + 7DT/16	ns
t_{HFIWR} FLAG3-0 _{IN} Hold after $\overline{RD}/\overline{WR}$ Deasserted ¹	0		0		ns
<i>Switching Characteristics:</i>					
t_{DFO} FLAG3-0 _{OUT} Delay after CLKIN High		16		16	ns
t_{HFO} FLAG3-0 _{OUT} Hold after CLKIN High	4		4		ns
t_{DFOE} CLKIN High to FLAG3-0 _{OUT} Enable	3		3		ns
t_{DFOD} CLKIN High to FLAG3-0 _{OUT} Disable		14		14	ns

NOTE

¹Flag inputs meeting these setup and hold times will affect conditional instructions in the following instruction cycle.

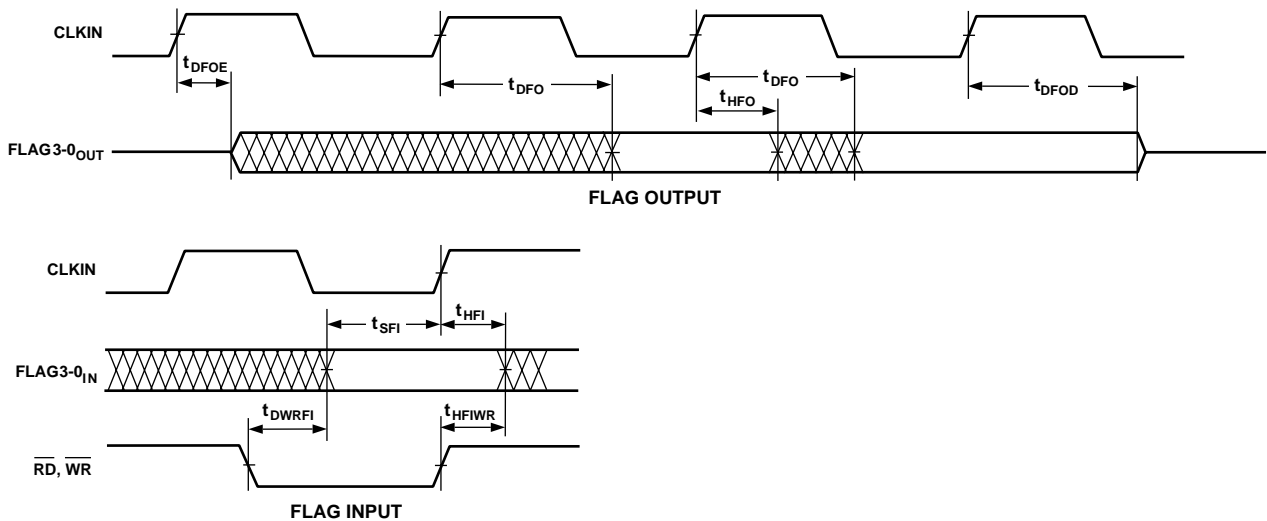

Figure 12. Flags

Memory Read—Bus Master

Use these specifications for asynchronous interfacing to memories (and memory-mapped peripherals) without reference to CLKIN. These specifications apply when the ADSP-21061 is the bus master accessing external memory space. These switching

characteristics also apply for bus master synchronous read/write timing (see Synchronous Read/Write—Bus Master). If these timing requirements are met, the synchronous read/write timing can be ignored (and vice versa).

Parameter	ADSP-21061 (5 V)		ADSP-21061L (3.3 V)		Units
	Min	Max	Min	Max	
<i>Timing Requirements:</i>					
t_{DAD}	Address, Selects Delay to Data Valid ^{1, 2}			$18 + DT + W$	ns
t_{DRLD}	\overline{RD} Low to Data Valid ¹			$12 + 5DT/8 + W$	ns
t_{HDA}	0.5	Data Hold from Address, Selects ³	0.5	$12 + 5DT/8 + W$	ns
t_{HDRH}	2.0	Data Hold from \overline{RD} High ³	2.0		ns
t_{DAAK}		ACK Delay from Address, Selects ^{2, 4}		$15 + 7DT/8 + W$	ns
t_{DSAK}		ACK Delay from \overline{RD} Low ⁴		$8 + DT/2 + W$	ns
<i>Switching Characteristics:</i>					
t_{DRHA}	$0 + H$	Address, Selects Hold after \overline{RD} High	$0 + H$		ns
t_{DARL}	$2 + 3DT/8$	Address, Selects to \overline{RD} Low ²	$2 + 3DT/8$		ns
t_{RW}	$12.5 + 5DT/8 + W$	\overline{RD} Pulsewidth	$12.5 + 5DT/8 + W$		ns
t_{RWR}	$8 + 3DT/8 + HI$	\overline{RD} High to \overline{WR} , \overline{RD} , \overline{DMAGx} Low	$8 + 3DT/8 + HI$		ns
t_{SADADC}	$0 + DT/4$	Address, Selects Setup before ADRCLK High ²	$0 + DT/4$		ns

$W = (\text{number of wait states specified in WAIT register}) \times t_{CK}$.

$HI = t_{CK}$ (if an address hold cycle or bus idle cycle occurs, as specified in WAIT register; otherwise $HI = 0$).

$H = t_{CK}$ (if an address hold cycle occurs as specified in WAIT register; otherwise $H = 0$).

NOTES

¹Data Delay/Setup: User must meet t_{DAD} or t_{DRLD} or synchronous specification t_{SSDATI} .

²The falling edge of \overline{MSx} , \overline{SW} , and \overline{BMS} is referenced.

³Data Hold: User must meet t_{HDA} or t_{HDRH} or synchronous specification t_{HSDATI} . See *System Hold Time Calculation* under Test Conditions for the calculation of hold times given capacitive and dc loads.

⁴ACK Delay/Setup: User must meet t_{DAAK} or t_{DSAK} or synchronous specification t_{SACKC} for deassertion of ACK (Low), all three specifications must be met for assertion of ACK (High).

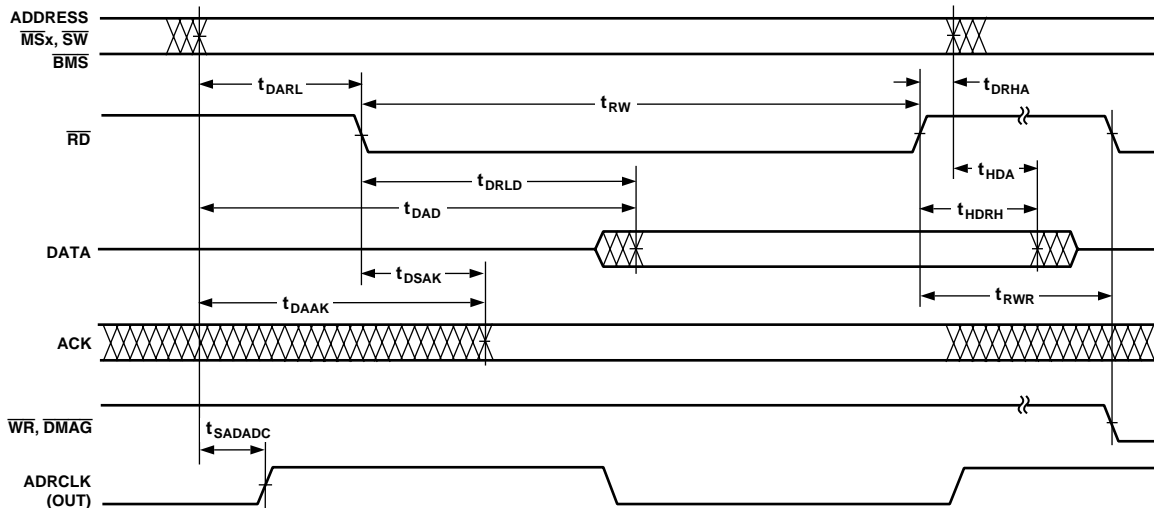

Figure 13. Memory Read—Bus Master

ADSP-21061/ADSP-21061L

Memory Write—Bus Master

Use these specifications for asynchronous interfacing to memories (and memory-mapped peripherals) without reference to CLKIN. These specifications apply when the ADSP-21061 is the bus master accessing external memory space. These switching

characteristics also apply for bus master synchronous read/write timing (see Synchronous Read/Write—Bus Master). If these timing requirements are met, the synchronous read/write timing can be ignored (and vice versa).

Parameter	ADSP-21061 (5 V)		ADSP-21061L (3.3 V)		Units
	Min	Max	Min	Max	
<i>Timing Requirements:</i>					
t_{DAAK}	ACK Delay from Address, Selects ^{1,2}		15 + 7DT/8 + W		ns
t_{DSAK}	ACK Delay from $\overline{\text{WR}}$ Low ¹		8 + DT/2 + W		ns
<i>Switching Characteristics:</i>					
t_{DAWH}	Address, Selects to $\overline{\text{WR}}$ Deasserted ²		17 + 15DT/16 + W		ns
t_{DAWL}	Address, Selects to $\overline{\text{WR}}$ Low ²		3 + 3DT/8		ns
t_{WW}	$\overline{\text{WR}}$ Pulsewidth		13 + 9DT/16 + W		ns
t_{DDWH}	Data Setup before $\overline{\text{WR}}$ High		7 + DT/2 + W		ns
t_{DWHa}	Address Hold after $\overline{\text{WR}}$ Deasserted		1 + DT/16 + H		ns
t_{DATRWH}	Data Disable after $\overline{\text{WR}}$ Deasserted ³		1 + DT/16 + H		ns
t_{WWR}	$\overline{\text{WR}}$ High to $\overline{\text{WR}}$, $\overline{\text{RD}}$, $\overline{\text{DMAGx}}$ Low		8 + 7DT/16 + H		ns
t_{DDWR}	Data Disable before $\overline{\text{WR}}$ or $\overline{\text{RD}}$ Low		5 + 3DT/8 + I		ns
t_{WDE}	$\overline{\text{WR}}$ Low to Data Enabled		-1 + DT/16		ns
t_{SADADC}	Address, Selects to ADRCLK High ²		0 + DT/4		ns

W = (number of wait states specified in WAIT register) × t_{CK} .

H = t_{CK} (if an address hold cycle occurs, as specified in WAIT register; otherwise H = 0).

I = t_{CK} (if a bus idle cycle occurs, as specified in WAIT register; otherwise I = 0).

NOTES

¹ACK Delay/Setup: User must meet t_{DAAK} or t_{DSAK} or synchronous specification t_{SACKC} for deassertion of ACK (Low), all three specifications must be met for assertion of ACK (High)

²The falling edge of $\overline{\text{MSx}}$, $\overline{\text{SW}}$, and $\overline{\text{BMS}}$ is referenced.

³See *System Hold Time Calculation* under Test Conditions for calculation of hold times given capacitive and dc loads.

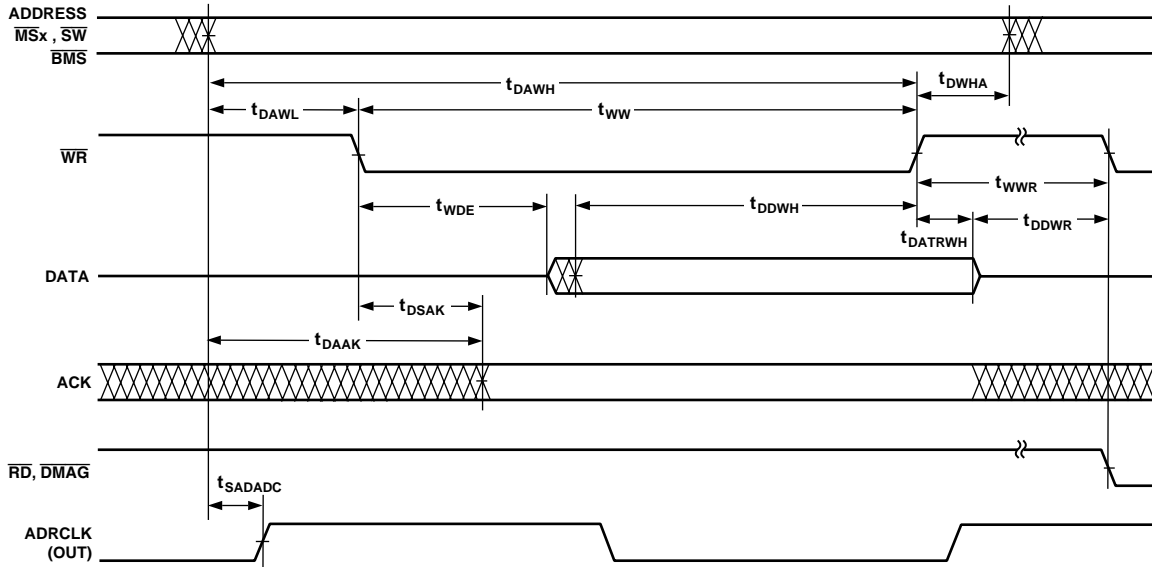

Figure 14. Memory Write—Bus Master

Synchronous Read/Write—Bus Master

Use these specifications for interfacing to external memory systems that require CLKIN—relative timing or for accessing a slave ADSP-21061 (in multiprocessor memory space). These synchronous switching characteristics are also valid during asynchronous memory reads and writes (see Memory Read—Bus Master and Memory Write—Bus Master).

When accessing a slave ADSP-2106x, these switching characteristics must meet the slave's timing requirements for synchronous read/writes (see Synchronous Read/Write—Bus Slave). The slave ADSP-21061 must also meet these (bus master) timing requirements for data and acknowledge setup and hold times.

Parameter	ADSP-21061 (5 V)		ADSP-21061L (3.3 V)		Units
	Min	Max	Min	Max	
<i>Timing Requirements:</i>					
t_{SSDATI}	Data Setup before CLKIN		2 + DT/8		ns
t_{SSDATI} (50 MHz)	Data Setup before CLKIN, $t_{CK} = 20 \text{ ns}^1$		1.5 + DT/8		ns
t_{HSDATI}	Data Hold after CLKIN		3.5 - DT/8		ns
t_{DAAK}	ACK Delay after Address, \overline{MSx} , \overline{SW} , $\overline{BMS}^{2,3}$		15 + 7 DT/8 + W		ns
t_{SACKC}	ACK Setup before CLKIN ²		6.5 + DT/4		ns
t_{HACK}	ACK Hold after CLKIN		-1 - DT/4		ns
<i>Switching Characteristics:</i>					
t_{DADRO}	Address, \overline{MSx} , \overline{BMS} , \overline{SW} Delay after CLKIN ²		6.5 - DT/8		ns
t_{HADRO}	Address, \overline{MSx} , \overline{BMS} , \overline{SW} Hold after CLKIN		-1 - DT/8		ns
t_{DPGC}	PAGE Delay after CLKIN		9 + DT/8		ns
t_{DRDO}	\overline{RD} High Delay after CLKIN		-1.5 - DT/8		ns
t_{DWRO}	\overline{WR} High Delay after CLKIN		4 - DT/8		ns
t_{DWRO} (50 MHz)	\overline{WR} High Delay after CLKIN, $t_{CK} = 20 \text{ ns}^1$		-2.5 - 3DT/16		ns
t_{DRWL}	$\overline{RD}/\overline{WR}$ Low Delay after CLKIN		4 - 3DT/16		ns
t_{SDDATO}	Data Delay after CLKIN		8 + DT/4		ns
t_{DATTR}	Data Disable after CLKIN ⁴		12 + DT/4		ns
t_{DADCKK}	Data Delay after CLKIN		19 + 5DT/16		ns
t_{ADRCK}	ADRCLK Delay after CLKIN		0 - DT/8		ns
t_{ADRCKH}	ADRCLK Width High		7 - DT/8		ns
t_{ADRCKL}	ADRCLK Width Low		4 + DT/8		ns
	t_{CK}		t_{CK}		ns
	$(t_{CK}/2 - 2)$		$(t_{CK}/2 - 2)$		ns
	$(t_{CK}/2 - 2)$		$(t_{CK}/2 - 2)$		ns

W = (number of Wait states specified in WAIT register) × t_{CK} .

NOTES

¹This specification applies to the ADSP-21061KS-200 (5 V, 50 MHz) operating at $t_{CK} < 25 \text{ ns}$. For all other devices, use the preceding timing specification of the same name.

²ACK Delay/Setup: User must meet t_{DAAK} or t_{DSAK} or synchronous specification t_{SACKC} for deassertion of ACK (Low), all three specifications must be met for assertion of ACK (High).

³Data Hold: User must meet t_{HDA} or t_{HDRH} or synchronous specification t_{HSDATI} . See *System Hold Time Calculation* under Test Conditions for the calculation of hold times given capacitive and dc loads.

⁴See *System Hold Time Calculation* under Test Conditions for calculation of hold times given capacitive and dc loads.

ADSP-21061/ADSP-21061L

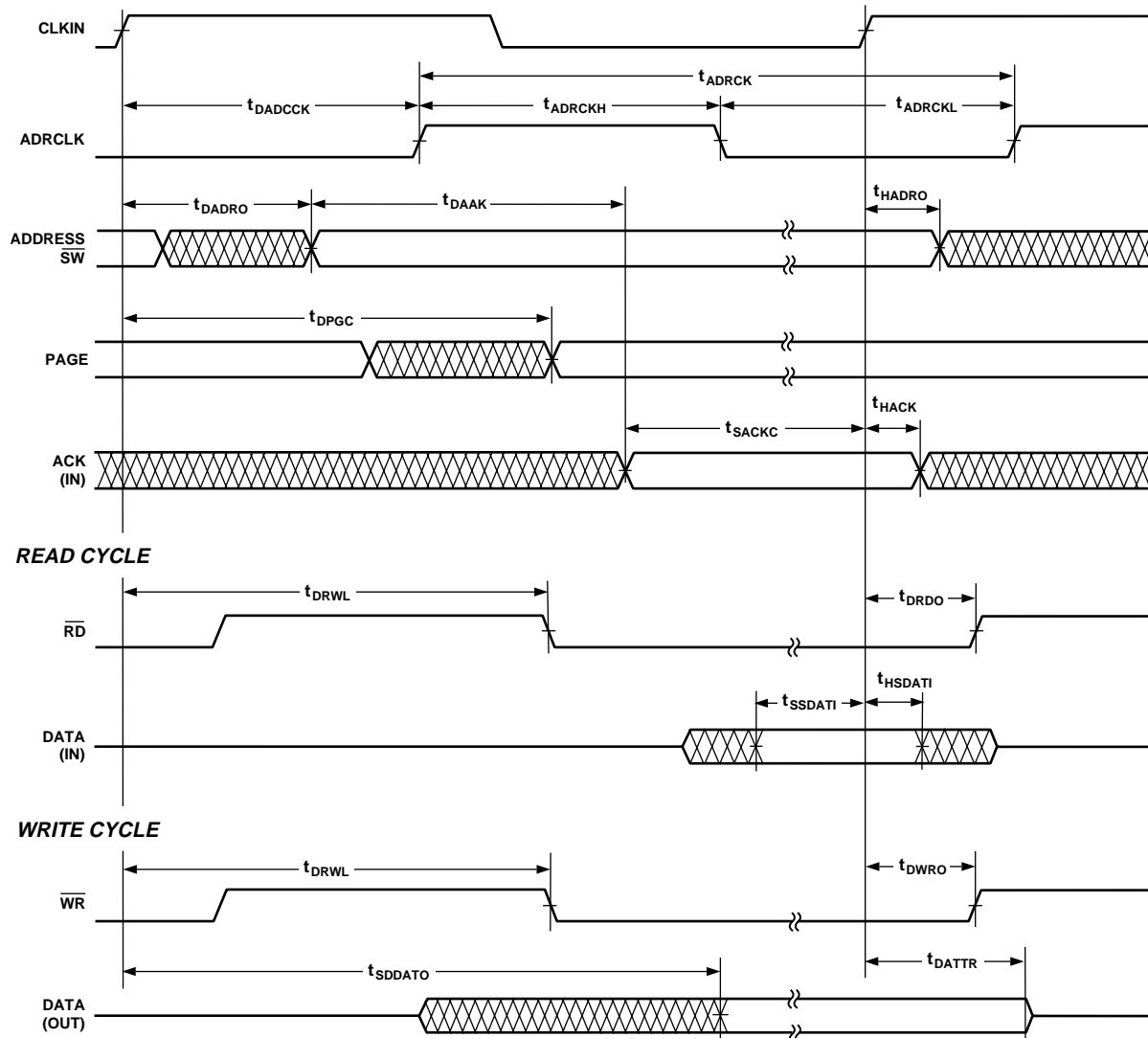

Figure 15. Synchronous Read/Write—Bus Master

Synchronous Read/Write—Bus Slave

Use these specifications for ADSP-21061 bus master accesses of a slave's IOP registers or internal memory (in multiprocessor

memory space). The bus master must meet these (bus slave) timing requirements.

Parameter	ADSP-21061 (5 V)		ADSP-21061L (3.3 V)		Units
	Min	Max	Min	Max	
<i>Timing Requirements:</i>					
t_{SADRI}	Address, \overline{SW} Setup before CLKIN		14 + DT/2		ns
t_{HADRI}	Address, \overline{SW} Hold before CLKIN		5 + DT/2		ns
t_{SRWLI}	$\overline{RD}/\overline{WR}$ Low Setup before CLKIN ¹		8.5 + 5DT/16		ns
t_{HRWLI}	$\overline{RD}/\overline{WR}$ Low Hold after CLKIN		-4 - 5DT/16		ns
t_{HRWLI}	$\overline{RD}/\overline{WR}$ Low Hold after CLKIN 44 MHz/50 MHz ²		8 + 7DT/16		ns
t_{RWHPH}	$\overline{RD}/\overline{WR}$ Pulse High		-3.5 - 5DT/16		ns
t_{SDATWH}	Data Setup before \overline{WR} High		8 + 7DT/16		ns
t_{HDATWH}	Data Hold after \overline{WR} High		3		ns
<i>Switching Characteristics:</i>					
t_{SDDATO}	Data Delay after CLKIN		19 + 5DT/16		ns
t_{DATTR}	Data Disable after CLKIN ³		0 - DT/8		ns
t_{DACKAD}	ACK Delay after Address, \overline{SW} ⁴		7 - DT/8		ns
t_{ACKTR}	ACK Disable after CLKIN ⁴		8		ns
			-1 - DT/8		ns
			6 - DT/8		ns
			-1 - DT/8		ns
			6 - DT/8		ns

NOTES

¹ t_{SRWLI} (min) = 9.5 + 5DT/16 when Multiprocessor Memory Space Wait State (MMSWS bit in WAIT register) is disabled; when MMSWS is enabled, t_{SRWLI} (min) = 4 + DT/8.

²This specification applies to the ADSP-21061LKS-176 (3.3 V, 44 MHz) and the ADSP-21061KS-200 (5 V, 50 MHz), operating at $t_{CK} < 25$ ns. For all other devices, use the preceding timing specification of the same name.

³See *System Hold Time Calculation* under Test Conditions for calculation of hold times given capacitive and dc loads.

⁴ t_{DACKAD} is true only if the address and \overline{SW} inputs have setup times (before CLKIN) greater than 10 + DT/8 and less than 19 + 3DT/4. If the address and \overline{SW} inputs have setup times greater than 19 + 3DT/4, then ACK is valid 15.5 + DT/4 (max) after CLKIN. A slave that sees an address with an M field match will respond with ACK regardless of the state of MMSWS or strobes. A slave will three-state ACK every cycle with t_{ACKTR} .

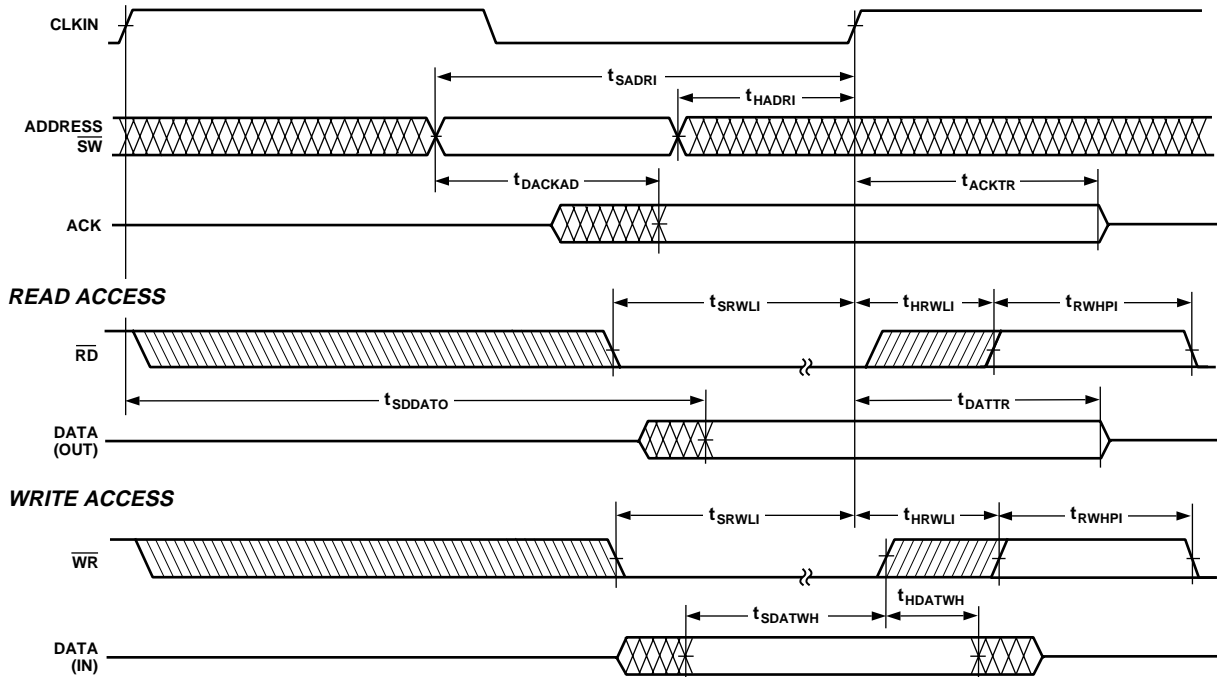

Figure 16. Synchronous Read/Write—Bus Slave

ADSP-21061/ADSP-21061L

Multiprocessor Bus Request and Host Bus Request

Use these specifications for passing of bus mastership between multiprocessor ADSP-21061s ($\overline{\text{BRx}}$) or a host processor ($\overline{\text{HBR}}$, $\overline{\text{HBG}}$).

Parameter	ADSP-21061 (5 V)		ADSP-21061L (3.3 V)		Units
	Min	Max	Min	Max	
<i>Timing Requirements:</i>					
t_{HBGRCSV}	$\overline{\text{HBG}}$ Low to $\overline{\text{RD}}/\overline{\text{WR}}/\overline{\text{CS}}$ Valid ¹				ns
t_{SHBRI}	20 + 3DT/4	20 + 5DT/4	20 + 3DT/4	20 + 5DT/4	ns
t_{HHBRI}	$\overline{\text{HBR}}$ Setup before CLKIN ²				ns
t_{SHBGI}	13 + DT/2	14 + 3DT/4	3 + DT/2	14 + 3DT/4	ns
t_{HHBGI}	$\overline{\text{HBG}}$ Setup before CLKIN				ns
t_{SBRI}	13 + DT/2	6 + DT/2	13 + DT/2	6 + DT/2	ns
t_{HBRI}	$\overline{\text{HBG}}$ Hold before CLKIN High				ns
t_{SRPBAI}	20 + 3DT/4	6 + DT/2	20 + 3DT/4	6 + DT/2	ns
t_{HRPBAI}		12 + 3DT/4		12 + 3DT/4	ns
<i>Switching Characteristics:</i>					
t_{DHBGO}	$\overline{\text{HBG}}$ Delay after CLKIN				ns
t_{HHBGO}	-2 - DT/8	7 - DT/8	-2 - DT/8	7 - DT/8	ns
t_{DBRO}	$\overline{\text{BRx}}$ Delay after CLKIN				ns
t_{HBRO}	-2 - DT/8	5.5 - DT/8	-2 - DT/8	5.5 - DT/8	ns
t_{DCPAO}	$\overline{\text{CPA}}$ Low Delay after CLKIN				ns
t_{TRCPA}	-2 - DT/8	6.5 - DT/8	-2 - DT/8	8.5 - DT/8	ns
t_{DRDYCS}	$\overline{\text{CPA}}$ Disable after CLKIN				ns
		4.5 - DT/8		4.5 - DT/8	
t_{TRDYHG}	REDY (O/D) or (A/D) Low from $\overline{\text{CS}}$ and $\overline{\text{HBR}}$ Low ⁴			12	ns
		8			
t_{ARDYTR}	REDY (O/D) Disable or REDY (A/D) High from $\overline{\text{HBG}}$ ⁴			40 + 27DT/16	ns
		44 + 27DT/16			
		10		10	ns

NOTES

¹For first asynchronous access after $\overline{\text{HBR}}$ and $\overline{\text{CS}}$ asserted, ADDR_{31-0} must be a non-MMS value 1/2 t_{CK} before $\overline{\text{RD}}$ or $\overline{\text{WR}}$ goes low or by t_{HBGRCSV} after $\overline{\text{HBG}}$ goes low. This is easily accomplished by driving an upper address signal high when $\overline{\text{HBG}}$ is asserted. See the Host Processor Control of the ADSP-2106x section in the *ADSP-2106x SHARC User's Manual, Second Edition*.

²Only required for recognition in the current cycle.

³ $\overline{\text{CPA}}$ assertion must meet the setup to CLKIN; deassertion does not need to meet the setup to CLKIN.

⁴(O/D) = open drain, (A/D) = active drive.

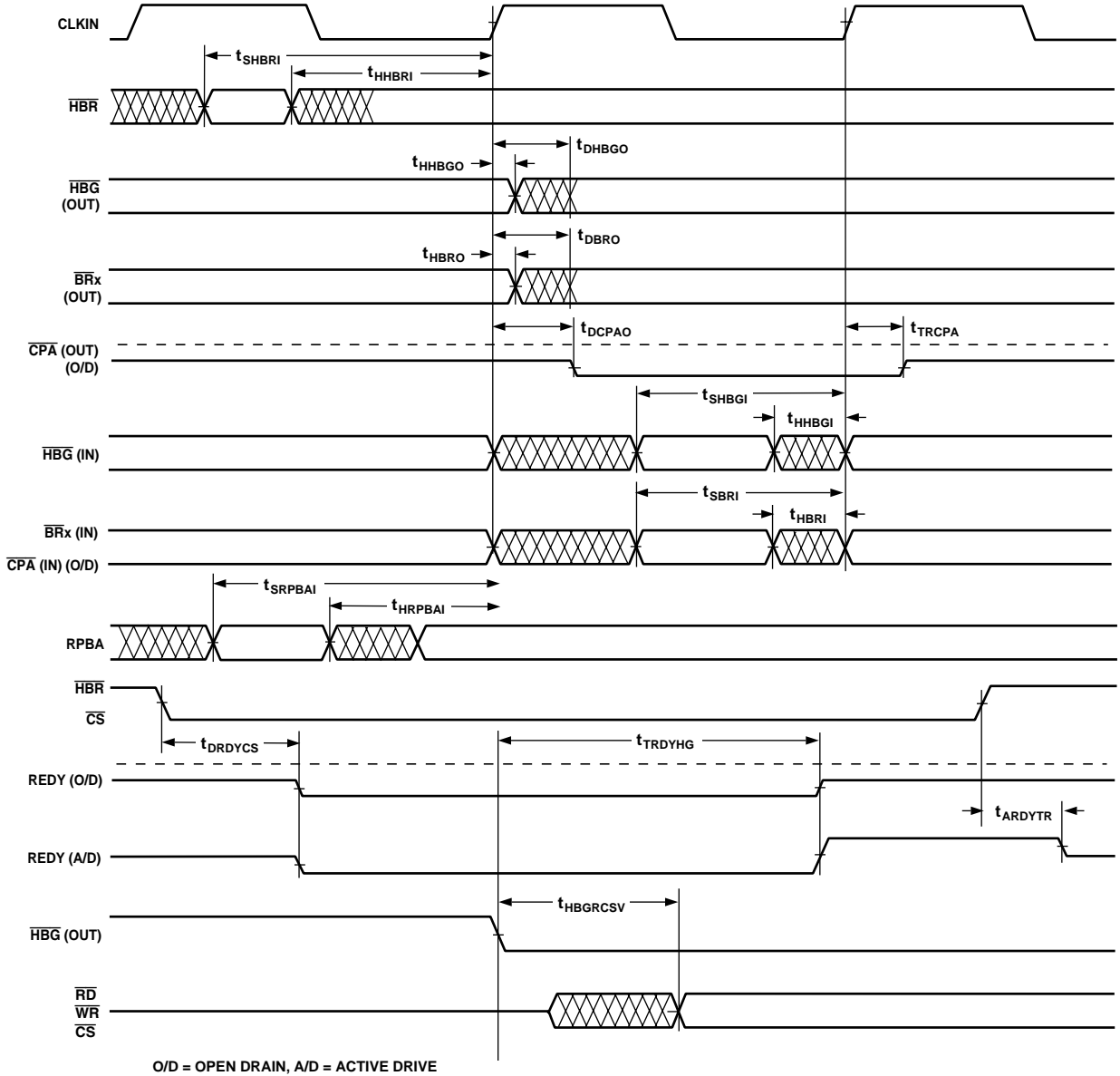

O/D = OPEN DRAIN, A/D = ACTIVE DRIVE

Figure 17. Multiprocessor Bus Request and Host Bus Request

ADSP-21061/ADSP-21061L

Asynchronous Read/Write—Host to ADSP-21061

Use these specifications for asynchronous host processor accesses of an ADSP-21061, after the host has asserted CS and HBR (low). After HBG is returned by the ADSP-21061, the host can

drive the \overline{RD} and \overline{WR} pins to access the ADSP-21061's internal memory or IOP registers. \overline{HBR} and \overline{HBG} are assumed low for this timing.

Parameter	ADSP-21061 (5 V)		ADSP-21061L (3.3 V)		Units	
	Min	Max	Min	Max		
Read Cycle						
<i>Timing Requirements:</i>						
t_{SADRDL}	Address Setup/ \overline{CS} Low before \overline{RD} Low ¹		0	0	ns	
t_{HADRDH}	Address Hold/ \overline{CS} Hold Low after \overline{RD}		0	0	ns	
t_{WRWH}	$\overline{RD}/\overline{WR}$ High Width		6	6	ns	
$t_{DRDHRDY}$	\overline{RD} High Delay after REDY (O/D) Disable		0	0	ns	
$t_{DRDHRDY}$	\overline{RD} High Delay after REDY (A/D) Disable		0	0	ns	
<i>Switching Characteristics:</i>						
$t_{SDATRDY}$	Data Valid before REDY Disable from Low		2	2	ns	
$t_{DRDYRDLDL}$	REDY (O/D) or (A/D) Low Delay after \overline{RD} Low			10	ns	
t_{RDYPRD}	REDY (O/D) or (A/D) Low Pulsewidth for Read		45 + DT	45 + DT	ns	
t_{HDARWH}	Data Disable after \overline{RD} High		2	8	ns	
Write Cycle						
<i>Timing Requirements:</i>						
t_{SCSWRL}	\overline{CS} Low Setup before \overline{WR} Low		0	0	ns	
t_{HCSWRH}	\overline{CS} Low Hold after \overline{WR} High		0	0	ns	
t_{SADWRH}	Address Setup before \overline{WR} High		5	5	ns	
t_{HADWRH}	Address Hold after \overline{WR} High		2	2	ns	
t_{WWRL}	\overline{WR} Low Width		8	8	ns	
t_{WRWH}	$\overline{RD}/\overline{WR}$ High Width		6	6	ns	
$t_{DWRHRDY}$	\overline{WR} High Delay after REDY (O/D) or (A/D) Disable		0	0	ns	
t_{SDATWH}	Data Setup before \overline{WR} High		3	3	ns	
t_{SDATWH} (50 MHz)	Data Setup before \overline{WR} High, $t_{CK} = 20 \text{ ns}^2$		1.5		ns	
t_{HDATWH}	Data Hold after \overline{WR} High		1	1	ns	
<i>Switching Characteristics:</i>						
$t_{DRDYWRDL}$	REDY (O/D) or (A/D) Low Delay after $\overline{WR}/\overline{CS}$ Low			11	ns	
t_{RDYPWR}	REDY (O/D) or (A/D) Low Pulsewidth for Write		15	15	ns	
t_{SRDYCK}	REDY (O/D) or (A/D) Disable to CLKIN		1 + 7DT/16	8 + 7DT/16	1 + 7DT/16	ns

NOTES

¹Not required if \overline{RD} and address are valid $t_{HBGRCSV}$ after \overline{HBG} goes low. For first access after \overline{HBR} asserted, ADDR 31-0 must be a non-MMS value $1/2 t_{CLK}$ before \overline{RD} or \overline{WR} goes low or by $t_{HBGRCSV}$ after \overline{HBG} goes low. This is easily accomplished by driving an upper address signal high when \overline{HBG} is asserted. See the Host Processor Control of the ADSP-2106x section in the *ADSP-2106x SHARC User's Manual, Second Edition*.

²This specification applies to the ADSP-21061KS-200 (5 V, 50 MHz) operating at $t_{CK} < 25 \text{ ns}$. For all other devices, use the preceding timing specification of the same name.

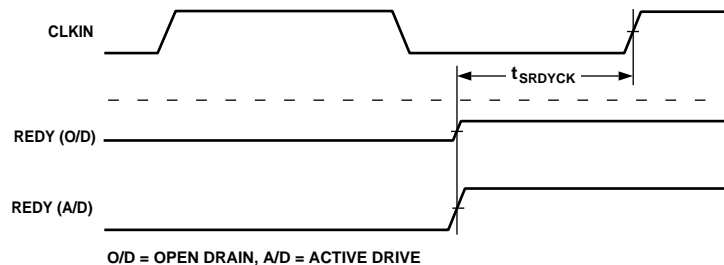

Figure 18a. Synchronous REDY Timing

ADSP-21061/ADSP-21061L

Three-State Timing—Bus Master, Bus Slave, $\overline{\text{HBR}}$, $\overline{\text{SBTS}}$

These specifications show how the memory interface is disabled (stops driving) or enabled (resumes driving) relative to CLKIN and the $\overline{\text{SBTS}}$ pin. This timing is applicable to bus master transition cycles (BTC) and host transition cycles (HTC) as well as the $\overline{\text{SBTS}}$ pin.

Parameter	ADSP-21061 (5 V)		ADSP-21061L (3.3 V)		Units
	Min	Max	Min	Max	
<i>Timing Requirements:</i>					
t_{STSCk}	$\overline{\text{SBTS}}$ Setup before CLKIN		12 + DT/2		ns
t_{HTSCk}	$\overline{\text{SBTS}}$ Hold before CLKIN		6 + DT/2		ns
<i>Switching Characteristics:</i>					
t_{MIENA}	Address/Select Enable after CLKIN		-1 - DT/8		ns
t_{MIENS}	Strobes Enable after CLKIN ¹		-1.5 - DT/8		ns
t_{MIENHG}	$\overline{\text{HBG}}$ Enable after CLKIN		-1.5 - DT/8		ns
t_{MITRA}	Address/Select Disable after CLKIN		0 - DT/4		ns
t_{MITRS}	Strobes Disable after CLKIN ¹		1.5 - DT/4		ns
t_{MITRHG}	$\overline{\text{HBG}}$ Disable after CLKIN		2 - DT/4		ns
t_{DATEN}	Data Enable after CLKIN ²		9 + 5DT/16		ns
t_{DATTR}	Data Disable after CLKIN ²		0 - DT/8		ns
t_{ACKEN}	ACK Enable after CLKIN ²		7.5 + DT/4		ns
t_{ACKTR}	ACK Disable after CLKIN ²		-1 - DT/8		ns
t_{ADCEN}	ADRCLK Enable after CLKIN		-2 - DT/8		ns
t_{ADCTR}	ADRCLK Disable after CLKIN		8 - DT/4		ns
t_{MTRHBG}	Memory Interface Disable before $\overline{\text{HBG}}$ Low ³		0 + DT/8		ns
t_{MENHBG}	Memory Interface Enable after $\overline{\text{HBG}}$ High ³		19 + DT		ns

NOTES

¹Strobes = $\overline{\text{RD}}$, $\overline{\text{WR}}$, $\overline{\text{MSx}}$, $\overline{\text{SW}}$, $\overline{\text{PAGE}}$, $\overline{\text{DMAG}}$, $\overline{\text{BMS}}$.

²In addition to bus master transition cycles, these specifications also apply to bus master and bus slave synchronous read/write.

³Memory Interface = Address, $\overline{\text{RD}}$, $\overline{\text{WR}}$, $\overline{\text{MSx}}$, $\overline{\text{SW}}$, $\overline{\text{HBG}}$, $\overline{\text{PAGE}}$, $\overline{\text{DMAGx}}$, $\overline{\text{BMS}}$ (in EPROM boot mode).

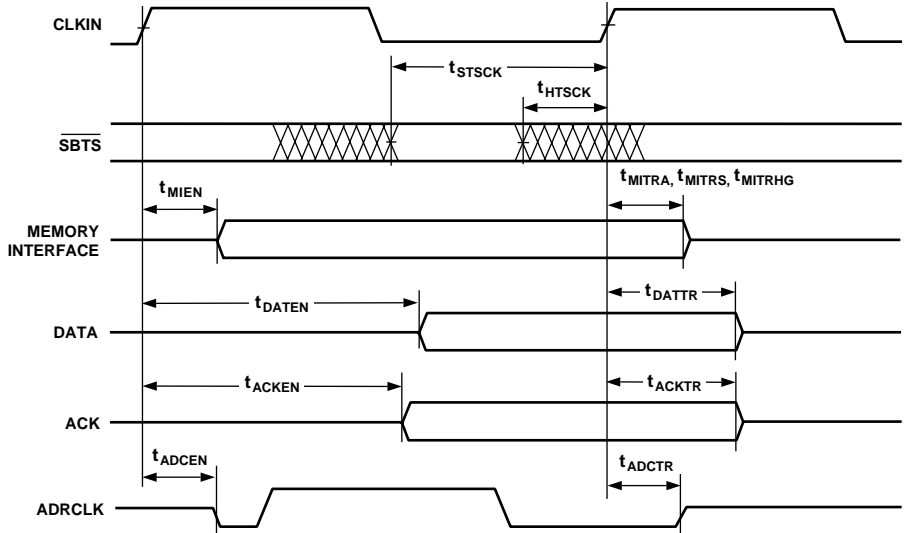
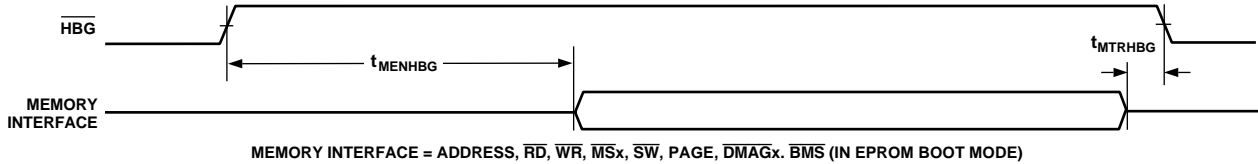

Figure 19a. Three-State Timing (Bus Transition Cycle, \overline{SBTS} Assertion)



MEMORY INTERFACE = ADDRESS, \overline{RD} , \overline{WR} , \overline{MSx} , \overline{SW} , PAGE, DMAGx. BMS (IN EPROM BOOT MODE)

Figure 19b. Three-State Timing (Host Transition Cycle)

ADSP-21061/ADSP-21061L

DMA Handshake

These specifications describe the three DMA handshake modes. In all three modes DMAR is used to initiate transfers. For handshake mode, DMAG controls the latching or enabling of data externally. For external handshake mode, the data transfer is controlled by the ADDR₃₁₋₀, RD, WR, SW, PAGE, MS₃₋₀, ACK and DMAG signals. For Paced Master mode, the data

transfer is controlled by ADDR₃₁₋₀, RD, WR, MS₃₋₀ and ACK (not DMAG). For Paced Master mode, the Memory Read-Bus Master, Memory Write-Bus Master, and Synchronous Read/Write-Bus Master timing specifications for ADDR₃₁₋₀, RD, WR, MS₃₋₀, SW, PAGE, DATA₄₇₋₀ and ACK also apply.

Parameter	ADSP-21061 (5 V)		ADSP-21061L (3.3 V)		Units
	Min	Max	Min	Max	
<i>Timing Requirements:</i>					
t _{SDRLC}	DMARx Low Setup before CLKIN ¹		5		ns
t _{SDRHC}	DMARx High Setup before CLKIN ¹		5		ns
t _{WDR}	DMARx Width Low (Nonsynchronous)		6		ns
t _{SDATDGL}	Data Setup after DMAGx Low ²	10 + 5DT/8		10 + 5DT/8	ns
t _{HDATIDG}	Data Hold after DMAGx High		2		ns
t _{DATDRH}	Data Valid after DMARx High ²	16 + 7DT/8		16 + 7DT/8	ns
t _{DMARLL}	DMAGx Low Edge to Low Edge	23 + 7DT/8		23.5 + 7DT/8	ns
t _{DMARH}	DMAGx Width High	6		6	ns
<i>Switching Characteristics:</i>					
t _{DDGL}	DMAGx Low Delay after CLKIN	9 + DT/4	15 + DT/4		ns
t _{WDGH}	DMAGx High Width	6 + 3DT/8		15 + DT/4	ns
t _{WDGL}	DMAGx Low Width	12 + 5DT/8		6 + 3DT/8	ns
t _{HDGC}	DMAGx High Delay after CLKIN	-2 - DT/8	6 - DT/8		ns
t _{DADGH}	Address Select Valid to DMAGx High	17 + DT		12 + 5DT/8	ns
t _{DDGHA}	Address Select Hold to DMAGx High	-0.5		-2 - DT/8	ns
t _{VDATDGH}	Data Valid before DMAGx High ³	8 + 9DT/16		6 - DT/8	ns
t _{DATRDGH}	Data Disable after DMAGx High ⁴	0	7		ns
t _{DGWRL}	WR Low before DMAGx Low	0	2		ns
t _{DGWRH}	DMAGx Low before WR High	10 + 5DT/8 + W			ns
t _{DGWRR}	WR High before DMAGx High	1 + DT/16	3 + DT/16		ns
t _{DGRDL}	RD Low before DMAGx Low	0	2		ns
t _{DRDGH}	RD Low before DMAGx High	11 + 9DT/16 + W			ns
t _{DGRDR}	RD High before DMAGx High	0	3		ns
t _{DGWR}	DMAGx High to WR, RD, DMAGx Low	5 + 3DT/8 + HI			ns

W = (number of wait states specified in WAIT register) × t_{CK}.

HI = t_{CK} (if an address hold cycle or bus idle cycle occurs, as specified in WAIT register; otherwise HI = 0).

NOTES

¹Only required for recognition in the current cycle.

²t_{SDATDGL} is the data setup requirement if DMARx is not being used to hold off completion of a write. Otherwise, if DMARx low holds off completion of the write, the data can be driven t_{DATDRH} after DMARx is brought high.

³t_{VDATDGH} is valid if DMARx is not being used to hold off completion of a read. If DMARx is used to prolong the read, then t_{VDATDGH} = 8 + 9DT/16 + (n × t_{CK}) where n equals the number of extra cycles that the access is prolonged.

⁴See *System Hold Time Calculation* under Test Conditions for calculation of hold times given capacitive and dc loads.

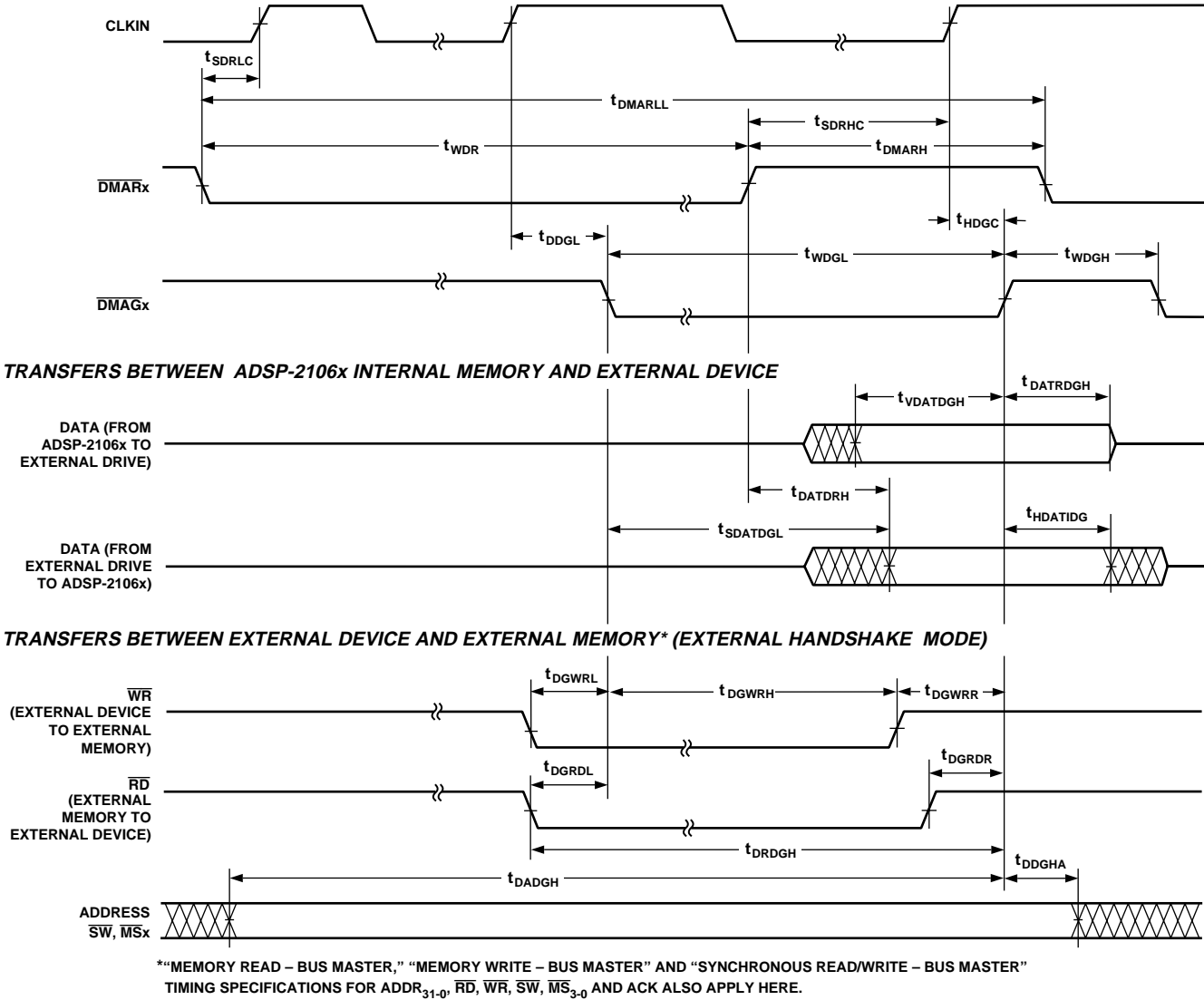

Figure 20. DMA Handshake Timing

ADSP-21061/ADSP-21061L

Serial Ports

Parameter	ADSP-21061 (5 V)		ADSP-21061L (3.3 V)		Units
	Min	Max	Min	Max	
External Clock					
<i>Timing Requirements:</i>					
t _{SFSE}	TFS/RFS Setup before TCLK/RCLK ¹		3.5	3.5	ns
t _{HFSE}	TFS/RFS Hold after TCLK/RCLK ^{1,2}		4	4	ns
t _{SDRE}	Receive Data Setup before RCLK ¹		1.5	1.5	ns
t _{HDRE}	Receive Data Hold after RCLK ¹		4	4	ns
t _{SCLKW}	TCLK/RCLK Width		9	9	ns
t _{SCLK}	TCLK/RCLK Period		t _{CK}	t _{CK}	ns
Internal Clock					
<i>Timing Requirements:</i>					
t _{SFSI}	TFS Setup before TCLK ¹ ; RFS Setup before RCLK ¹		8	8	ns
t _{HFSI}	TFS/RFS Hold after TCLK/RCLK ^{1,2}		1	1	ns
t _{SDRI}	Receive Data Setup before RCLK ¹		3	3	ns
t _{HDRI}	Receive Data Hold after RCLK ¹		3	3	ns
External or Internal Clock					
<i>Switching Characteristics:</i>					
t _{DFSE}	RFS Delay after RCLK (Internally Generated RFS) ³		13	13	ns
t _{HOFSE}	RFS Hold after RCLK (Internally Generated RFS) ³		3	3	ns
External Clock					
<i>Switching Characteristics:</i>					
t _{DFSE}	TFS Delay after TCLK (Internally Generated TFS) ³		13	13	ns
t _{HOFSE}	TFS Hold after TCLK (Internally Generated TFS) ³		3	3	ns
t _{DDTE}	Transmit Data Delay after TCLK ³		16	16	ns
t _{HODTE}	Transmit Data Hold after TCLK ³		5	5	ns
Internal Clock					
<i>Switching Characteristics:</i>					
t _{DFSI}	TFS Delay after TCLK (Internally Generated TFS) ³		4.5	4.5	ns
t _{HOFSI}	TFS Hold after TCLK (Internally Generated TFS) ³		-1.5	-1.5	ns
t _{DDTI}	Transmit Data Delay after TCLK ³		7.5	7.5	ns
t _{HDTI}	Transmit Data Hold after TCLK ³		0	0	ns
t _{SCLKIW}	TCLK/RCLK Width		(t _{SCLK} /2) - 2.5	(t _{SCLK} /2) + 2.5	ns
Enable and Three-State					
<i>Switching Characteristics:</i>					
t _{DDTEN}	Data Enable from External TCLK ³		4.5	3.5	ns
t _{DDTTE}	Data Disable from External TCLK ³		10.5	10.5	ns
t _{DDTIN}	Data Enable from Internal TCLK ³		0	-0.5	ns
t _{DDTTI}	Data Disable from Internal TCLK ³		3	3	ns
t _{DCLK}	TCLK/RCLK Delay from CLKIN		22 + 3DT/8	22 + 3DT/8	ns
t _{DPTR}	SPORT Disable after CLKIN		17	17	ns
External Late Frame Sync					
<i>Switching Characteristics:</i>					
t _{DDTLFSE}	Data Delay from Late External TFS or External RFS with MCE = 1, MFD = 0 ⁴		12	12	ns
t _{DDTENFS}	Data Enable from late FS or MCE = 1, MFD = 0 ⁴		3.5	3.5	ns

To determine whether communication is possible between two devices at clock speed n , the following specifications must be confirmed: 1) frame sync delay and frame sync setup and hold, 2) data delay and data setup and hold, and 3) SCLK width.

NOTES

¹Referenced to sample edge.

²RFS hold after RCK when MCE = 1, MFD = 0 is 0 ns minimum from drive edge. TFS hold after TCK for late external. TFS is 0 ns minimum from drive edge.

³Referenced to drive edge.

⁴MCE = 1, TFS enable and TFS valid follow t_{DDTLFSE} and t_{DDTENFS}.

DATA RECEIVE— INTERNAL CLOCK

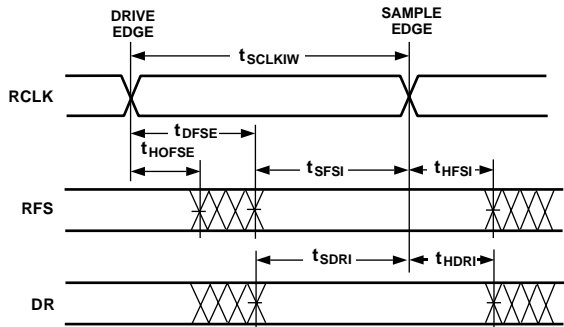

DATA RECEIVE— EXTERNAL CLOCK

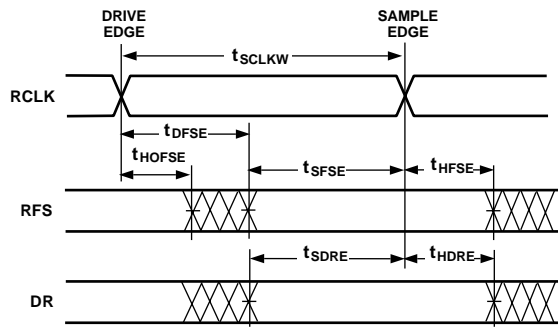

NOTE: EITHER THE RISING EDGE OR FALLING EDGE OF RCLK, TCLK CAN BE USED AS THE ACTIVE SAMPLING EDGE.

DATA TRANSMIT— INTERNAL CLOCK

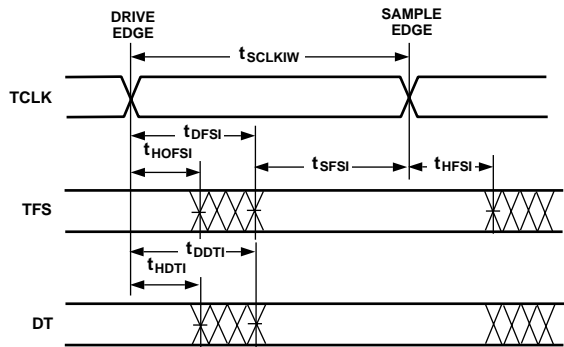

DATA TRANSMIT— EXTERNAL CLOCK

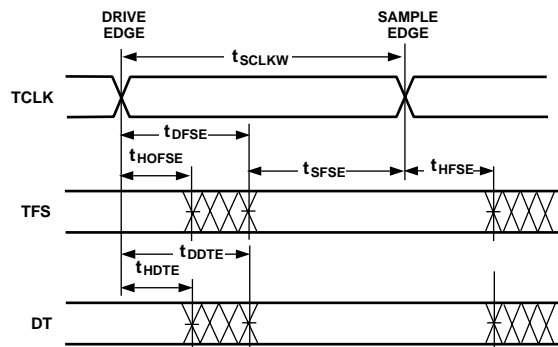

NOTE: EITHER THE RISING EDGE OR FALLING EDGE OF RCLK, TCLK CAN BE USED AS THE ACTIVE SAMPLING EDGE.

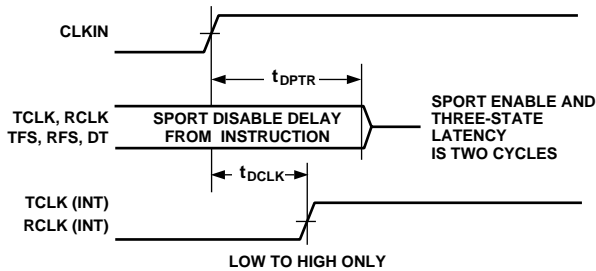
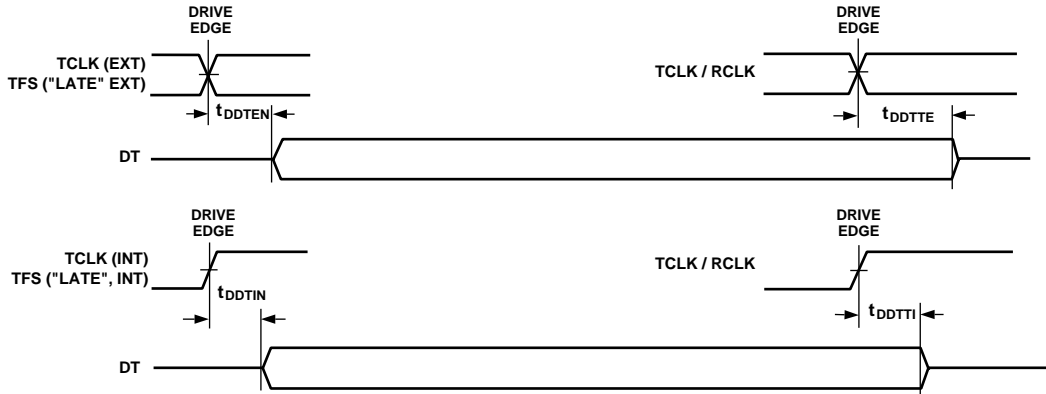
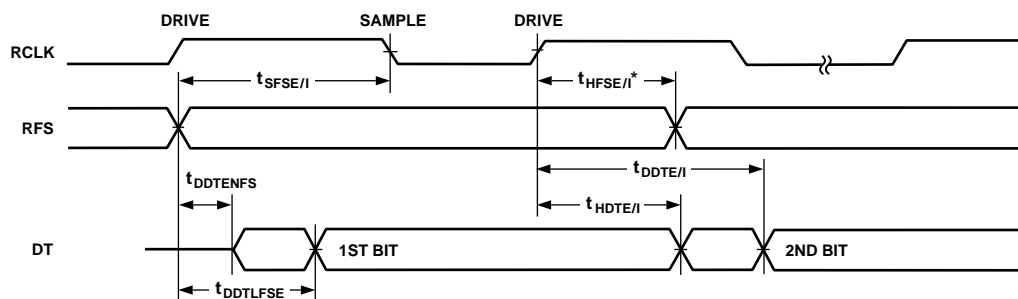

Figure 21. Serial Ports

ADSP-21061/ADSP-21061L

EXTERNAL RFS WITH MCE = 1, MFD = 0



LATE EXTERNAL TFS

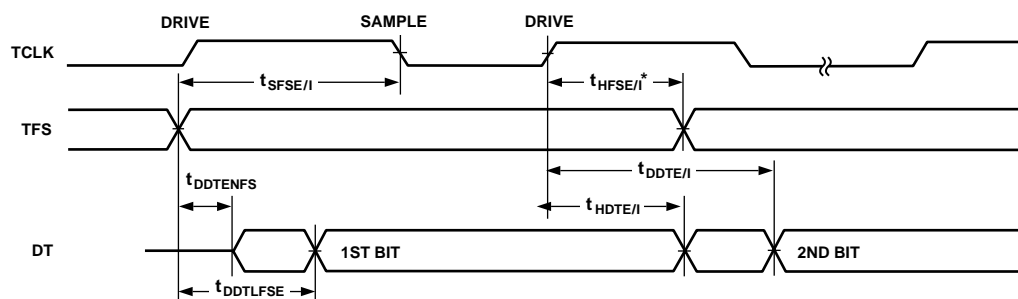

*RFS HOLD AFTER RCLK WHEN MCE = 1, MFD = 0 IS 0ns MINIMUM FROM DRIVE EDGE.
 TFS HOLD AFTER TCLK FOR LATE EXTERNAL. TFS IS 0ns MINIMUM FROM DRIVE EDGE.

Figure 22. External Late Frame Sync

JTAG Test Access Port and Emulation

Parameter	ADSP-21061 (5 V)		ADSP-21061L (3.3 V)		Units
	Min	Max	Min	Max	
<i>Timing Requirements:</i>					
t_{TCK} TCK Period	t_{CK}		t_{CK}		ns
t_{STAP} TDI, TMS Setup before TCK High	t_{CK}		t_{CK}		ns
t_{HTAP} TDI, TMS Hold after TCK High	6		6		ns
t_{SSYS} System Inputs Setup before TCK Low ¹	7		7		ns
t_{HSYS} System Inputs Hold after TCK Low ¹	18		18		ns
t_{TRSTW} \overline{TRST} Pulsewidth	$4t_{CK}$		$4t_{CK}$		ns
<i>Switching Characteristics:</i>					
t_{DTDO} TDO Delay from TCK Low		13		13	ns
t_{DSYS} System Outputs Delay after TCK Low ²		18.5		18.5	ns

NOTES

¹System Inputs = DATA₄₇₋₀, ADDR₃₁₋₀, \overline{RD} , \overline{WR} , ACK, \overline{SBTS} , \overline{SW} , \overline{HBR} , \overline{HBG} , \overline{CS} , $\overline{DMAR1}$, $\overline{DMAR2}$, \overline{BR}_{6-1} , ID₂₋₀, RPBA, \overline{IRQ}_{2-0} , FLAG₃₋₀, DR0, DR1, TCLK0, TCLK1, RCLK0, RCLK1, TFS0, TFS1, RFS0, RFS1, EBOOT, LBOOT, \overline{BMS} , CLKIN, RESET.

²System Outputs = DATA₄₇₋₀, ADDR₃₁₋₀, \overline{MS}_{3-0} , \overline{RD} , \overline{WR} , PAGE, ADRCLK, \overline{SW} , \overline{HBG} , REDY, $\overline{DMAG1}$, $\overline{DMAG2}$, \overline{BR}_{6-1} , \overline{CPA} , FLAG₃₋₀, TIMEXP, DT0, DT1, TCLK0, TCLK1, RCLK0, RCLK1, TFS0, TFS1, RFS0, RFS1, \overline{BMS} .

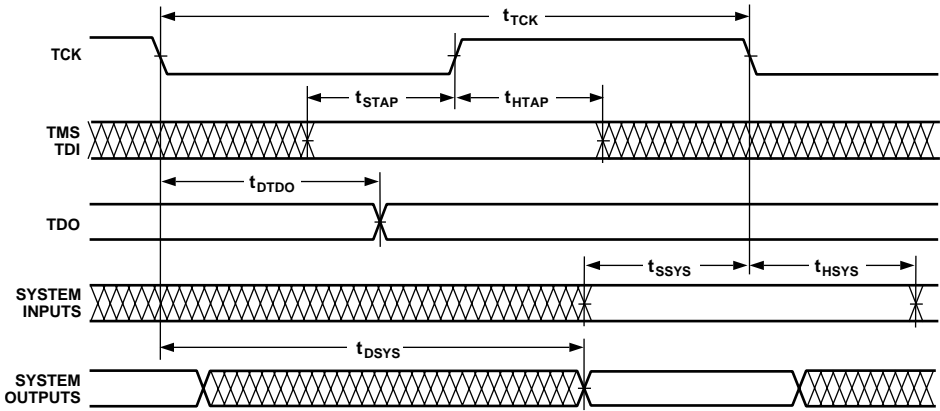

Figure 23. JTAG Test Access Port and Emulation

ADSP-21061/ADSP-21061L

OUTPUT DRIVE CURRENTS

Figure 27 shows typical I-V characteristics for the output drivers of the ADSP-2106x. The curves represent the current drive capability of the output drivers as a function of output voltage.

POWER DISSIPATION

Total power dissipation has two components, one due to internal circuitry and one due to the switching of external output drivers. Internal power dissipation is dependent on the instruction execution sequence and the data operands involved. Internal power dissipation is calculated in the following way:

$$P_{INT} = I_{DDIN} \times V_{DD}$$

The external component of total power dissipation is caused by the switching of output pins. Its magnitude depends on:

- the number of output pins that switch during each cycle (O)
- the maximum frequency at which they can switch (f)
- their load capacitance (C)
- their voltage swing (V_{DD})

and is calculated by:

$$P_{EXT} = O \times C \times V_{DD}^2 \times f$$

The load capacitance should include the processor's package capacitance (C_{IN}). The switching frequency includes driving the load high and then back low. Address and data pins can drive high and low at a maximum rate of 1/(2t_{CK}). The write strobe can switch every cycle at a frequency of 1/t_{CK}. Select pins switch at 1/(2t_{CK}), but selects can switch on each cycle.

Example:

Estimate P_{EXT} with the following assumptions:

- A system with one bank of external data memory RAM (32-bit)
- Four 128K × 8 RAM chips are used, each with a load of 10 pF
- External data memory writes occur every other cycle, a rate of 1/(4t_{CK}), with 50% of the pins switching
- The instruction cycle rate is 40 MHz (t_{CK} = 25 ns).

The P_{EXT} equation is calculated for each class of pins that can drive:

Table II. External Power Calculations (5 V Device)

Pin Type	# of Pins	% Switching	× C	× f	× V _{DD} ²	= P _{EXT}
Address	15	50	× 44.7 pF	× 10 MHz	× 25 V	= 0.084 W
$\overline{MS0}$	1	0	× 44.7 pF	× 10 MHz	× 25 V	= 0.000 W
\overline{WR}	1	-	× 44.7 pF	× 20 MHz	× 25 V	= 0.022 W
Data	32	50	× 14.7 pF	× 10 MHz	× 25 V	= 0.059 W
ADDRCLK	1	-	× 4.7 pF	× 20 MHz	× 25 V	= 0.002 W

$$P_{EXT} = 0.167 \text{ W}$$

Table III. External Power Calculations (3.3 V Device)

Pin Type	# of Pins	% Switching	× C	× f	× V _{DD} ²	= P _{EXT}
Address	15	50	× 44.7 pF	× 10 MHz	× 10.9 V	= 0.037 W
$\overline{MS0}$	1	0	× 44.7 pF	× 10 MHz	× 10.9 V	= 0.000 W
\overline{WR}	1	-	× 44.7 pF	× 20 MHz	× 10.9 V	= 0.010 W
Data	32	50	× 14.7 pF	× 10 MHz	× 10.9 V	= 0.026 W
ADDRCLK	1	-	× 4.7 pF	× 20 MHz	× 10.9 V	= 0.001 W

$$P_{EXT} = 0.074 \text{ W}$$

A typical power consumption can now be calculated for these conditions by adding a typical internal power dissipation:

$$P_{TOTAL} = P_{EXT} + (I_{DDIN2} \times 5.0 \text{ V})$$

Note that the conditions causing a worst-case P_{EXT} are different from those causing a worst-case P_{INT}. Maximum P_{INT} cannot occur while 100% of the output pins are switching from all ones to all zeros. Note also that it is not common for an application to have 100% or even 50% of the outputs switching simultaneously.

TEST CONDITIONS

Output Disable Time

Output pins are considered to be disabled when they stop driving, go into a high impedance state, and start to decay from their output high or low voltage. The time for the voltage on the bus to decay by ΔV is dependent on the capacitive load, C_L and the load current, I_L. This decay time can be approximated by the following equation:

$$t_{DECAY} = \frac{C_L \Delta V}{I_L}$$

The output disable time t_{DIS} is the difference between t_{MEASURED} and t_{DECAY} as shown in Figure 24. The time t_{MEASURED} is the interval from when the reference signal switches to when the output voltage decays ΔV from the measured output high or output low voltage. t_{DECAY} is calculated with test loads C_L and I_L, and with ΔV equal to 0.5 V.

Output Enable Time

Output pins are considered to be enabled when they have made a transition from a high impedance state to when they start driving. The output enable time t_{ENA} is the interval from when a reference signal reaches a high or low voltage level to when the output has reached a specified high or low trip point, as shown in the Output Enable/Disable diagram (Figure 24). If multiple pins (such as the data bus) are enabled, the measurement value is that of the first pin to start driving.

Example System Hold Time Calculation

To determine the data output hold time in a particular system, first calculate t_{DECAY} using the equation given above. Choose ΔV to be the difference between the ADSP-2106x's output voltage and the input threshold for the device requiring the hold time. A typical ΔV will be 0.4 V. C_L is the total bus capacitance (per data line), and I_L is the total leakage or three-state current (per data line). The hold time will be t_{DECAY} plus the minimum disable time (i.e., t_{DATRWH} for the write cycle).

Capacitive Loading

Output delays and holds are based on standard capacitive loads: 50 pF on all pins (see Figure 25). The delay and hold specifications given should be derated by a factor of $1.5 \text{ ns}/50 \text{ pF}$ for loads other than the nominal value of 50 pF. Figures 28–29, 32–33 show how output rise time varies with capacitance. Figures 30, 34 show graphically how output delays and holds vary with load capacitance. (Note that this graph or derating does not apply to output disable delays; see the previous section *Output Disable Time* under Test Conditions.) The graphs of Figures 28, 29 and 30 may not be linear outside the ranges shown.

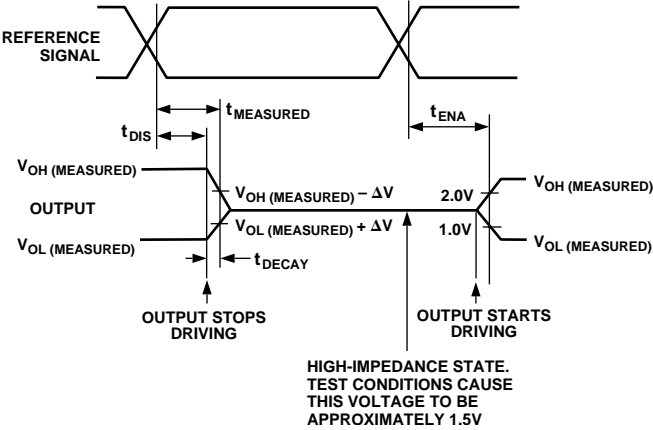

Figure 24. Output Enable/Disable

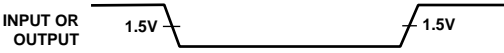

Figure 26. Voltage Reference Levels for AC Measurements (Except Output Enable/Disable)

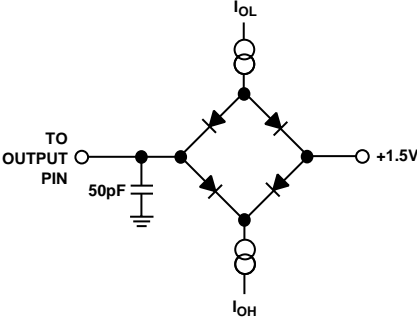

Figure 25. Equivalent Device Loading for AC Measurements (Includes All Fixtures)

ADSP-21061/ADSP-21061L

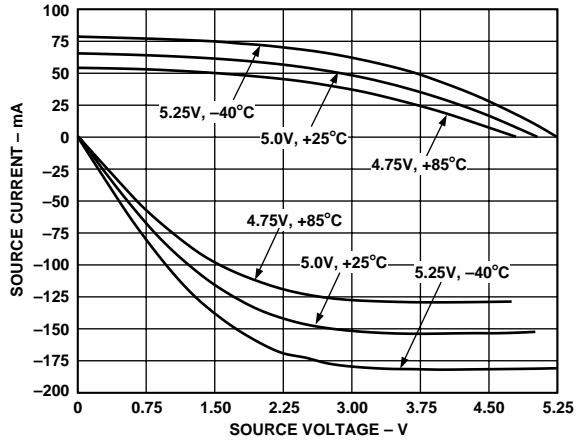

Figure 27. ADSP-2106x Typical Drive Currents ($V_{DD} = 5 V$)

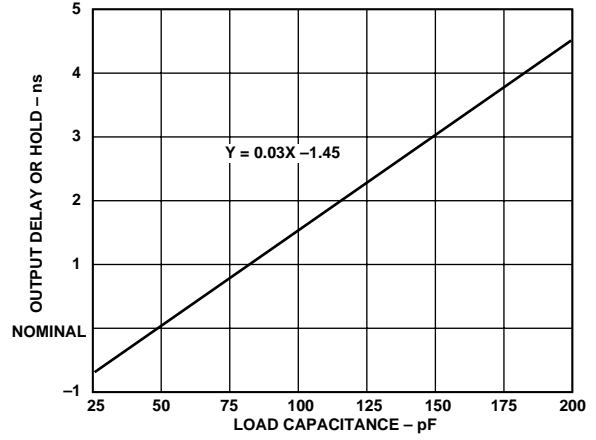

Figure 30. Typical Output Delay or Hold vs. Load Capacitance (at Maximum Case Temperature) ($V_{DD} = 5 V$)

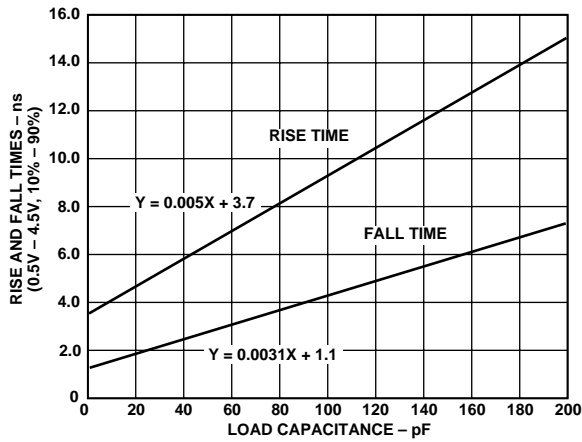

Figure 28. Typical Output Rise Time (10%–90% V_{DD}) vs. Load Capacitance ($V_{DD} = 5 V$)

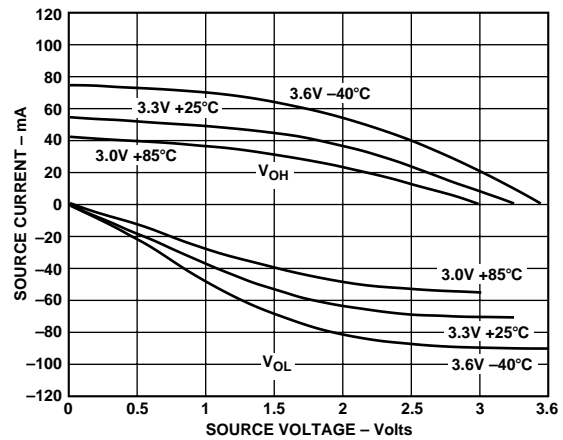

Figure 31. ADSP-2106x Typical Drive Currents ($V_{DD} = 3.3 V$)

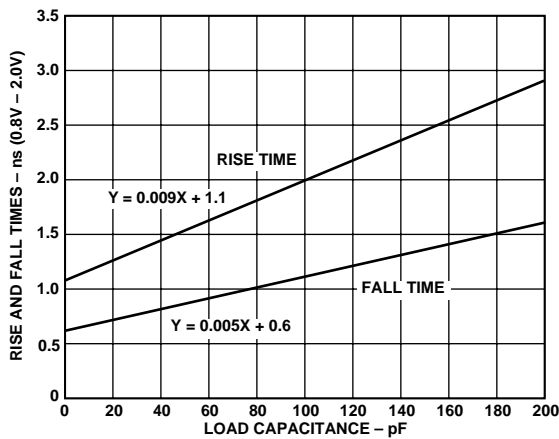

Figure 29. Typical Output Rise Time (0.8 V–2.0 V) vs. Load Capacitance ($V_{DD} = 5 V$)

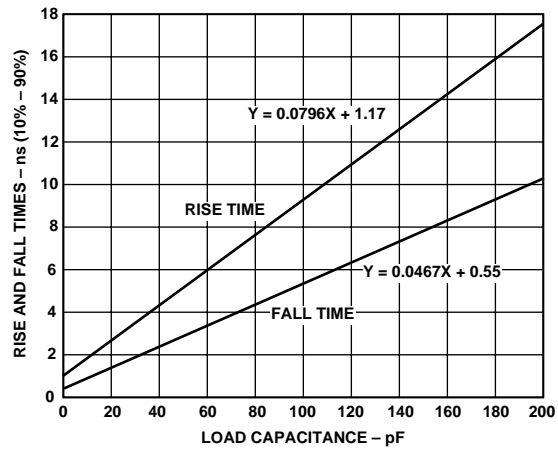

Figure 32. Typical Output Rise Time (10%–90% V_{DD}) vs. Load Capacitance ($V_{DD} = 3.3 V$)

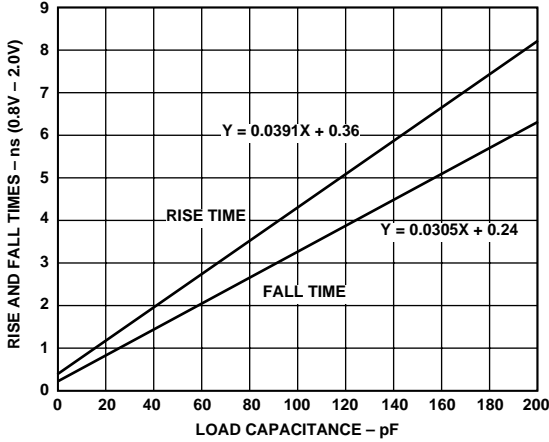

Figure 33. Typical Output Rise Time (0.8 V-2.0 V) vs. Load Capacitance ($V_{DD} = 3.3\text{ V}$)

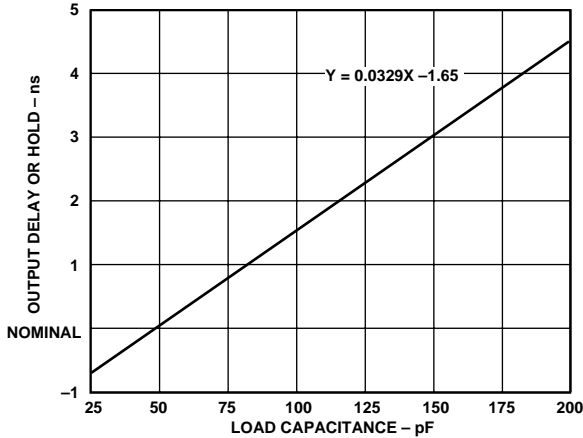

Figure 34. Typical Output Delay or Hold vs. Load Capacitance (at Maximum Case Temperature) ($V_{DD} = 3.3\text{ V}$)

ENVIRONMENTAL CONDITIONS

Thermal Characteristics

The ADSP-21061 (5 V) device is packaged in a 240-lead thermally enhanced PQFP. The top surface of the package contains a copper slug from which most of the die heat is dissipated. The slug is flush with the top surface of the package. Note that the copper slug is internally connected to GND through the device substrate.* The ADSP-2106x is specified for a case temperature (T_{CASE}). To ensure that the T_{CASE} data sheet specification is not exceeded, a heatsink and/or an air flow source may be used. A heatsink should be attached with a thermal adhesive.

$$T_{CASE} = T_{AMB} + (PD \times \theta_{CA})$$

T_{CASE} = Case temperature (measured on top surface of package)

PD = Power dissipation in W (this value depends upon the specific application; a method for calculating PD is shown under Power Dissipation).

θ_{CA} = Value from table below.

*The ADSP-21061L is packaged in a 240-lead PQFP without a copper heat slug.

ADSP-21061 (5 V)

$\theta_{JC} = 0.3^\circ\text{C/W}$ Airflow (Linear Ft./Min.)	0	100	200	400	600
θ_{CA} ($^\circ\text{C/W}$)	10	9	8	7	6

NOTES

This represents thermal resistance at total power of 5 W.

With air flow, no variance is seen in θ_{CA} with power.

θ_{CA} at 0 LFM varies with power: at 2W, $\theta_{CA} = 14^\circ\text{C/W}$, at 3W $\theta_{CA} = 11^\circ\text{C/W}$.

ADSP-21061L (3.3 V)

$\theta_{JC} = 6.3^\circ\text{C/W}$ Airflow (Linear Ft./Min.)	0	100	200	400	600
θ_{CA} ($^\circ\text{C/W}$)	19.6	17.6	15.6	13.9	12.2
θ_{JA} ($^\circ\text{C/W}$)	25.9	23.9	21.9	20.2	18.5

NOTE

With air flow, no variance is seen in θ_{CA} with power.

ADSP-21061/ADSP-21061L

240-LEAD METRIC PQFP PIN CONFIGURATIONS

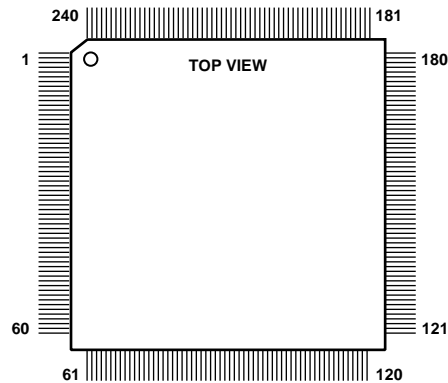

Pin No.	Pin Name	Pin No.	Pin Name	Pin No.	Pin Name	Pin No.	Pin Name	Pin No.	Pin Name	Pin No.	Pin Name
1	TDI	41	ADDR20	81	TCLK0	121	DATA41	161	DATA14	201	NC
2	TRST	42	ADDR21	82	TFS0	122	DATA40	162	DATA13	202	NC
3	VDD	43	GND	83	DR0	123	DATA39	163	DATA12	203	NC
4	TDO	44	ADDR22	84	RCLK0	124	VDD	164	GND	204	NC
5	TIMEXP	45	ADDR23	85	RFS0	125	DATA38	165	DATA11	205	VDD
6	EMU	46	ADDR24	86	VDD	126	DATA37	166	DATA10	206	NC
7	ICSA	47	VDD	87	VDD	127	DATA36	167	DATA9	207	NC
8	FLAG3	48	GND	88	GND	128	GND	168	VDD	208	NC
9	FLAG2	49	VDD	89	ADRCLK	129	NC	169	DATA8	209	NC
10	FLAG1	50	ADDR25	90	REDY	130	DATA35	170	DATA7	210	NC
11	FLAG0	51	ADDR26	91	HBG	131	DATA34	171	DATA6	211	NC
12	GND	52	ADDR27	92	CS	132	DATA33	172	GND	212	GND
13	ADDR0	53	GND	93	RD	133	VDD	173	DATA5	213	NC
14	ADDR1	54	MS3	94	WR	134	VDD	174	DATA4	214	NC
15	VDD	55	MS2	95	GND	135	GND	175	DATA3	215	NC
16	ADDR2	56	MS1	96	VDD	136	DATA32	176	VDD	216	NC
17	ADDR3	57	MS0	97	GND	137	DATA31	177	DATA2	217	NC
18	ADDR4	58	SW	98	CLKIN	138	DATA30	178	DATA1	218	NC
19	GND	59	BMS	99	ACK	139	GND	179	DATA0	219	VDD
20	ADDR5	60	ADDR28	100	DMAG2	140	DATA29	180	GND	220	GND
21	ADDR6	61	GND	101	DMAG1	141	DATA28	181	GND	221	VDD
22	ADDR7	62	VDD	102	PAGE	142	DATA27	182	NC	222	NC
23	VDD	63	VDD	103	VDD	143	VDD	183	NC	223	NC
24	ADDR8	64	ADDR29	104	BR6	144	VDD	184	NC	224	NC
25	ADDR9	65	ADDR30	105	BR5	145	DATA26	185	NC	225	NC
26	ADDR10	66	ADDR31	106	BR4	146	DATA25	186	NC	226	NC
27	GND	67	GND	107	BR3	147	DATA24	187	NC	227	NC
28	ADDR11	68	SPTS	108	BR2	148	GND	188	VDD	228	GND
29	ADDR12	69	DMAR2	109	BRI	149	DATA23	189	NC	229	ID2
30	ADDR13	70	DMAR1	110	GND	150	DATA22	190	NC	230	ID1
31	VDD	71	HBR	111	VDD	151	DATA21	191	NC	231	ID0
32	ADDR14	72	DT1	112	GND	152	VDD	192	NC	232	LBOOT
33	ADDR15	73	TCLK1	113	DATA47	153	DATA20	193	NC	233	RPBA
34	GND	74	TFS1	114	DATA46	154	DATA19	194	NC	234	RESET
35	ADDR16	75	DR1	115	DATA45	155	DATA18	195	GND	235	EBOOT
36	ADDR17	76	RCLK1	116	VDD	156	GND	196	GND	236	IRQ2
37	ADDR18	77	RFS1	117	DATA44	157	DATA17	197	VDD	237	IRQ1
38	VDD	78	GND	118	DATA43	158	DATA16	198	NC	238	IRQ0
39	VDD	79	CPA	119	DATA42	159	DATA15	199	NC	239	TCK
40	ADDR19	80	DT0	120	GND	160	VDD	200	NC	240	TMS

OUTLINE DIMENSIONS

Dimensions shown in inches and (mm).

240-Lead Metric Thermally Enhanced PQFP (5 V Device Only)

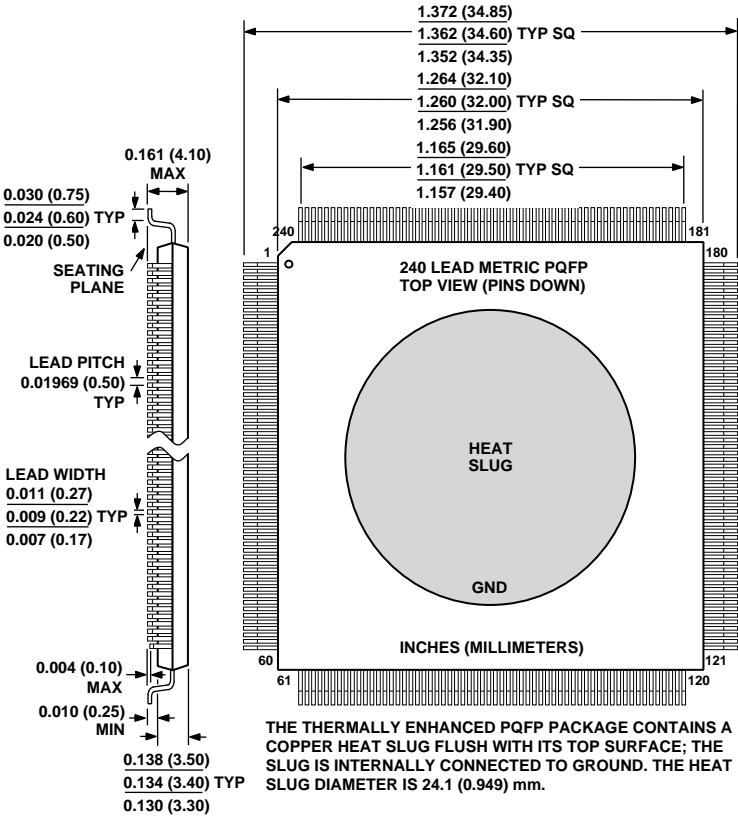

NOTE:
 THE ACTUAL POSITION OF EACH LEAD IS WITHIN (0.08) 0.0032 FROM ITS IDEAL POSITION WHEN MEASURED IN THE LATERAL DIRECTION.
 CENTER FIGURES ARE TYPICAL UNLESS OTHERWISE NOTED.

ADSP-21061/ADSP-21061L

OUTLINE DIMENSIONS

Dimensions shown in inches and (mm).

240-Lead Metric PQFP (3.3 V Device Only)

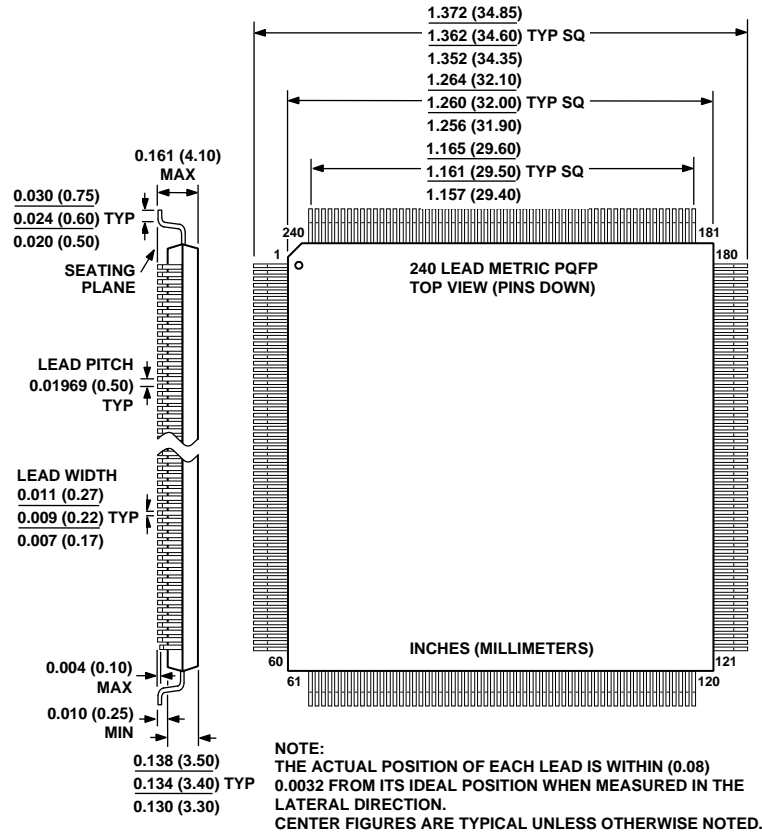

ORDERING GUIDE

Part Number*	Case Temperature Range	Instruction Rate	On-Chip SRAM	Operating Voltage
ADSP-21061KS-133	0°C to +85°C	33 MHz	1 Mbit	5 V
ADSP-21061KS-160	0°C to +85°C	40 MHz	1 Mbit	5 V
ADSP-21061KS-200	0°C to +85°C	50 MHz	1 Mbit	5 V
ADSP-21061LKS-160	0°C to +85°C	40 MHz	1 Mbit	3.3 V
ADSP-21061LKS-176	0°C to +85°C	44 MHz	1 Mbit	3.3 V
ADSP-21061LAS-176	-40°C Ambient to +85°C Case	44 MHz	1 Mbit	3.3 V

The package options are as follows: the ADSP-21061 (5 V) is available in the 240-lead thermally enhanced package and the ADSP-21061L (3.3 V) is available in the 240-lead standard (no heat slug) package.