



## 8-Channel, 24-Bit ANALOG-TO-DIGITAL CONVERTER with FLASH Memory

### FEATURES

- 24 BITS NO MISSING CODES
- 0.0015% INL
- 22 BITS EFFECTIVE RESOLUTION (PGA = 1), 19 BITS (PGA = 128)
- 4K BYTES OF FLASH MEMORY PROGRAMMABLE FROM 2.7V TO 5.25V
- PGA FROM 1 TO 128
- SINGLE CYCLE SETTLING MODE
- PROGRAMMABLE DATA OUTPUT RATES UP TO 1kHz
- PRECISION ON-CHIP 1.25V/2.5V REFERENCE: ACCURACY: 0.2% DRIFT: 5ppm/°C
- EXTERNAL DIFFERENTIAL REFERENCE OF 0.1V TO 2.5V
- ON-CHIP CALIBRATION
- PIN-COMPATIBLE WITH ADS1216
- SPI™ COMPATIBLE
- 2.7V TO 5.25V
- < 1mW POWER CONSUMPTION

### APPLICATIONS

- INDUSTRIAL PROCESS CONTROL
- LIQUID/GAS CHROMATOGRAPHY
- BLOOD ANALYSIS
- SMART TRANSMITTERS
- PORTABLE INSTRUMENTATION
- WEIGHT SCALES
- PRESSURE TRANSDUCERS

### DESCRIPTION

The ADS1218 is a precision, wide dynamic range, delta-sigma, Analog-to-Digital (A/D) converter with 24-bit resolution and Flash memory operating from 2.7V to 5.25V supplies. The delta-sigma, A/D converter provides up to 24 bits of no missing code performance and effective resolution of 22 bits.

The eight input channels are multiplexed. Internal buffering can be selected to provide a very high input impedance for direct connection to transducers or low-level voltage signals. Burnout current sources are provided that allow for the detection of an open or shorted sensor. An 8-bit Digital-to-Analog (D/A) converter provides an offset correction with a range of 50% of the FSR (Full-Scale Range).

The PGA (Programmable Gain Amplifier) provides selectable gains of 1 to 128 with an effective resolution of 19 bits at a gain of 128. The A/D conversion is accomplished with a second-order delta-sigma modulator and programmable sinc filter. The reference input is differential and can be used for ratiometric conversion. The on-board current DACs (Digital-to-Analog Converters) operate independently with the maximum current set by an external resistor.

The serial interface is SPI-compatible. Eight bits of digital I/O are also provided that can be used for input or output. The ADS1218 is designed for high-resolution measurement applications in smart transmitters, industrial process control, weight scales, chromatography, and portable instrumentation.

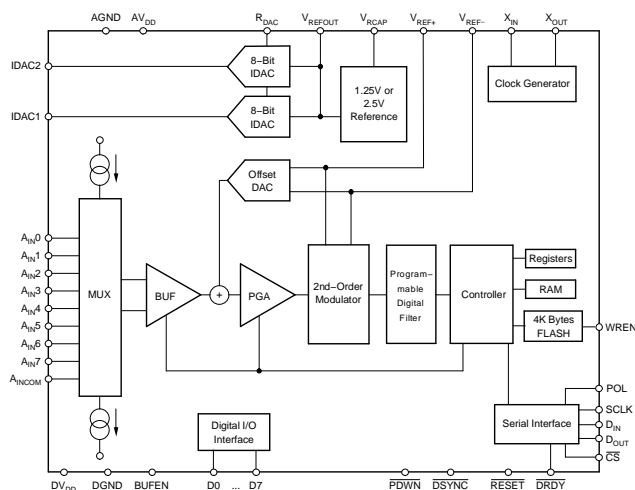

Please be aware that an important notice concerning availability, standard warranty, and use in critical applications of Texas Instruments semiconductor products and disclaimers thereto appears at the end of this data sheet.

SPI is a trademark of Motorola.

All trademarks are the property of their respective owners.



This integrated circuit can be damaged by ESD. Texas Instruments recommends that all integrated circuits be handled with appropriate precautions. Failure to observe proper handling and installation procedures can cause damage.

ESD damage can range from subtle performance degradation to complete device failure. Precision integrated circuits may be more susceptible to damage because very small parametric changes could cause the device not to meet its published specifications.

## ORDERING INFORMATION

For the most current package and ordering information, see the Package Option Addendum at the end of this document, or see the TI web site at [www.ti.com](http://www.ti.com).

## ABSOLUTE MAXIMUM RATINGS<sup>(1)</sup>

AV <sub>DD</sub> to AGND	-0.3V to +6V
DV <sub>DD</sub> to DGND	-0.3V to +6V
Input Current	100mA, Momentary
Input Current	10mA, Continuous
A <sub>IN</sub>	GND – 0.5V to AV <sub>DD</sub> + 0.5V
AV <sub>DD</sub> to DV <sub>DD</sub>	-6V to +6V
AGND to DGND	-0.3V to +0.3V
Digital Input Voltage to GND	-0.3V to DV <sub>DD</sub> + 0.3V
Digital Output Voltage to GND	-0.3V to DV <sub>DD</sub> + 0.3V
Maximum Junction Temperature	+150°C
Operating Temperature Range	-40°C to +85°C
Storage Temperature Range	-60°C to +100°C
Lead Temperature (soldering, 10s)	+300°C

(1) Stresses above those listed under Absolute Maximum Ratings may cause permanent damage to the device. Exposure to absolute maximum conditions for extended periods may affect device reliability.

**ELECTRICAL CHARACTERISTICS:  $AV_{DD} = 5V$**

All specifications  $T_{MIN}$  to  $T_{MAX}$ ,  $AV_{DD} = +5V$ ,  $DV_{DD} = +2.7V$  to  $5.25V$ ,  $f_{MOD} = 19.2kHz$ ,  $f_{OSC} = 2.4576MHz$ ,  $PGA = 1$ , Buffer On,  $R_{DAC} = 150k\Omega$ ,  $V_{REF} \equiv (REF\ IN+) - (REF\ IN-) = +2.5V$ , and  $f_{DATA} = 10Hz$ , unless otherwise specified.

PARAMETER	CONDITIONS	ADS1218			UNIT
		MIN	TYP	MAX	
<b>ANALOG INPUT (<math>A_{IN0} - A_{IN7}</math>, <math>A_{INCOM}</math>)</b>					
Analog Input Range	Buffer Off	AGND – 0.1		$AV_{DD} + 0.1$	V
	Buffer On	AGND + 0.05		$AV_{DD} - 1.5$	V
Full-Scale Input Voltage Range	(In+) – (In–), See Block Diagram			$\pm V_{REF}/PGA$	V
Differential Input Impedance	Buffer Off		5/PGA		M $\Omega$
Input Current	Buffer On		0.5		nA
Bandwidth					
Fast Settling Filter	–3dB		$0.469 \times f_{DATA}$		Hz
Sinc <sup>2</sup> Filter	–3dB		$0.318 \times f_{DATA}$		Hz
Sinc <sup>3</sup> Filter	–3dB		$0.262 \times f_{DATA}$		Hz
Programmable Gain Amplifier	User-Selectable Gain Ranges	1		128	
Input Capacitance			9		pF
Input Leakage Current	Modulator Off, T = +25°C		5		pA
Burnout Current Sources			2		$\mu A$
<b>OFFSET DAC</b>					
Offset DAC Range			$\pm V_{REF}/(2 \times PGA)$		V
Offset DAC Monotonicity		8			Bits
Offset DAC Gain Error			$\pm 10$		%
Offset DAC Gain Error Drift			1		ppm/°C
<b>SYSTEM PERFORMANCE</b>					
Resolution		24			Bits
No Missing Codes	sinc <sup>3</sup>			24	Bits
Integral Nonlinearity	End Point Fit			$\pm 0.0015$	% of FS
Offset Error <sup>(1)</sup>	Before Calibration		7.5		ppm of FS
Offset Drift <sup>(1)</sup>			0.02		ppm of FS/°C
Gain Error	After Calibration		0.005		%
Gain Error Drift <sup>(1)</sup>			0.5		ppm/°C
Common-Mode Rejection					
	at DC	100			dB
	$f_{CM} = 60Hz$ , $f_{DATA} = 10Hz$		130		dB
	$f_{CM} = 50Hz$ , $f_{DATA} = 50Hz$		120		dB
	$f_{CM} = 60Hz$ , $f_{DATA} = 60Hz$		120		dB
Normal-Mode Rejection					
	$f_{SIG} = 50Hz$ , $f_{DATA} = 50Hz$		100		dB
	$f_{SIG} = 60Hz$ , $f_{DATA} = 60Hz$		100		dB
Output Noise			See Typical Characteristics		
Power-Supply Rejection	at DC, dB = $-20 \log(\Delta V_{OUT}/\Delta V_{DD})$ <sup>(2)</sup>	80	95		dB
<b>VOLTAGE REFERENCE INPUT</b>					
Reference Input Range	REF IN+, REF IN–	0		$AV_{DD}$	V
$V_{REF}$	$V_{REF} \equiv (REF\ IN+) - (REF\ IN-)$	0.1	2.5	2.6	V
Common-Mode Rejection	at DC		120		dB
Common-Mode Rejection	$f_{VREFCM} = 60Hz$ , $f_{DATA} = 60Hz$		120		dB
Bias Current <sup>(3)</sup>	$V_{REF} = 2.5V$		1.3		$\mu A$

- (1) Calibration can minimize these errors.
- (2)  $\Delta V_{OUT}$  is change in digital result.
- (3) 12pF switched capacitor at  $f_{SAMP}$  clock frequency.

**ELECTRICAL CHARACTERISTICS: AV<sub>DD</sub> = 5V (continued)**

All specifications T<sub>MIN</sub> to T<sub>MAX</sub>, AV<sub>DD</sub> = +5V, DV<sub>DD</sub> = +2.7V to 5.25V, f<sub>MOD</sub> = 19.2kHz, f<sub>OSC</sub> = 2.4576MHz, PGA = 1, Buffer On, R<sub>DAC</sub> = 150kΩ, V<sub>REF</sub> ≡ (REF IN+) – (REF IN–) = +2.5V, and f<sub>DATA</sub> = 10Hz, unless otherwise specified.

PARAMETER	CONDITIONS	ADS1218			UNIT
		MIN	TYP	MAX	
<b>ON-CHIP VOLTAGE REFERENCE</b>					
Output Voltage	REF HI = 1 at +25°C	2.495	2.50	2.505	V
	REF HI = 0		1.25		V
Short-Circuit Current Source			8		mA
Short-Circuit Current Sink			50		μA
Short-Circuit Duration	Sink or Source		Indefinite		
Drift			5		ppm/°C
Noise	BW = 0.1Hz to 100Hz		10		μV <sub>PP</sub>
Output Impedance	Sourcing 100μA		3		Ω
Startup Time			50		μs
<b>IDAC</b>					
Full-Scale Output Current	R <sub>DAC</sub> = 150kΩ, Range = 1		0.5		mA
	R <sub>DAC</sub> = 150kΩ, Range = 2		1		mA
	R <sub>DAC</sub> = 150kΩ, Range = 3		2		mA
	R <sub>DAC</sub> = 15kΩ, Range = 3		20		mA
Maximum Short-Circuit Current Duration	R <sub>DAC</sub> = 10kΩ		Indefinite		
	R <sub>DAC</sub> = 0Ω			10	Minutes
Monotonicity	R <sub>DAC</sub> = 150kΩ	8			Bits
Compliance Voltage		0		AV <sub>DD</sub> – 1	V
Output Impedance			See Typical Characteristics		
PSRR	V <sub>OUT</sub> = AV <sub>DD</sub> /2		400		ppm/V
Absolute Error	Individual IDAC		5		%
Absolute Drift	Individual IDAC		75		ppm/°C
Mismatch Error	Between IDACs, Same Range and Code		0.25		%
Mismatch Drift	Between IDACs, Same Range and Code		15		ppm/°C
<b>POWER-SUPPLY REQUIREMENTS</b>					
Power-Supply Voltage	AV <sub>DD</sub>	4.75		5.25	V
Analog Current (I <sub>ADC</sub> + I <sub>VREF</sub> + I <sub>DAC</sub> )	$\overline{PDWN}$ = 0, or SLEEP		1		nA
ADC Current (I <sub>ADC</sub> )	PGA = 1, Buffer Off		175	275	μA
	PGA = 128, Buffer Off		500	750	μA
	PGA = 1, Buffer On		250	350	μA
	PGA = 128, Buffer On		900	1375	μA
V <sub>REF</sub> Current (I <sub>VREF</sub> )			250	375	μA
I <sub>DAC</sub> Current (I <sub>DAC</sub> )	Excludes Load Current		480	675	μA
Digital Current	Normal Mode, DV <sub>DD</sub> = 5V		180	275	μA
	SLEEP Mode, DV <sub>DD</sub> = 5V		150		μA
	Read Data Continuous Mode, DV <sub>DD</sub> = 5V		230		μA
	$\overline{PDWN}$ = Low		1		nA
Power Dissipation	PGA = 1, Buffer Off, REFEN = 0, I <sub>DACS</sub> Off, DV <sub>DD</sub> = 5V		1.8	2.8	mW
<b>TEMPERATURE RANGE</b>					
Operating		–40		+85	°C
Storage		–60		+100	°C

**ELECTRICAL CHARACTERISTICS:  $AV_{DD} = 3V$**

All specifications  $T_{MIN}$  to  $T_{MAX}$ ,  $AV_{DD} = +3V$ ,  $DV_{DD} = +2.7V$  to  $5.25V$ ,  $f_{MOD} = 19.2kHz$ ,  $f_{OSC} = 2.4576MHz$ ,  $PGA = 1$ , Buffer On,  $R_{DAC} = 75k\Omega$ ,  $V_{REF} \equiv (REF\ IN+) - (REF\ IN-) = +1.25V$ , and  $f_{DATA} = 10Hz$ , unless otherwise specified.

PARAMETER	CONDITIONS	ADS1218			UNIT
		MIN	TYP	MAX	
<b>ANALOG INPUT (<math>A_{IN0} - A_{IN7}</math>, <math>A_{INCOM}</math>)</b>					
Analog Input Range	Buffer Off	AGND – 0.1		$AV_{DD} + 0.1$	V
	Buffer On	AGND + 0.05		$AV_{DD} - 1.5$	V
Full-Scale Input Voltage Range	(In+) – (In–), See Block Diagram			$\pm V_{REF}/PGA$	V
Input Impedance	Buffer Off		5/PGA		M $\Omega$
Input Current	Buffer On		0.5		nA
Bandwidth					
Fast Settling Filter	–3dB		$0.469 \times f_{DATA}$		Hz
Sinc <sup>2</sup> Filter	–3dB		$0.318 \times f_{DATA}$		Hz
Sinc <sup>3</sup> Filter	–3dB		$0.262 \times f_{DATA}$		Hz
Programmable Gain Amplifier	User-Selectable Gain Ranges	1		128	
Input Capacitance			9		pF
Input Leakage Current	Modulator Off, T = +25°C		5		pA
Burnout Current Sources			2		$\mu A$
<b>OFFSET DAC</b>					
Offset DAC Range			$\pm V_{REF}/(2 \times PGA)$		V
Offset DAC Monotonicity		8			Bits
Offset DAC Gain Error			$\pm 10$		%
Offset DAC Gain Error Drift			2		ppm/°C
<b>SYSTEM PERFORMANCE</b>					
Resolution		24			Bits
No Missing Codes				24	Bits
Integral Nonlinearity	End Point Fit			$\pm 0.0015$	% of FS
Offset Error <sup>(1)</sup>	Before Calibration		15		ppm of FS
Offset Drift <sup>(1)</sup>			0.04		ppm of FS/°C
Gain Error	After Calibration		0.010		%
Gain Error Drift <sup>(1)</sup>			1.0		ppm/°C
Common-Mode Rejection					
	at DC	100			dB
	$f_{CM} = 60Hz$ , $f_{DATA} = 10Hz$		130		dB
	$f_{CM} = 50Hz$ , $f_{DATA} = 50Hz$		120		dB
	$f_{CM} = 60Hz$ , $f_{DATA} = 60Hz$		120		dB
Normal-Mode Rejection					
	$f_{SIG} = 50Hz$ , $f_{DATA} = 50Hz$		100		dB
	$f_{SIG} = 60Hz$ , $f_{DATA} = 60Hz$		100		dB
Output Noise			See Typical Characteristics		
Power-Supply Rejection	at DC, dB = $-20 \log(\Delta V_{OUT}/\Delta V_{DD})$ <sup>(2)</sup>	75	90		dB
<b>VOLTAGE REFERENCE INPUT</b>					
Reference Input Range	REF IN+, REF IN–	0		$AV_{DD}$	V
$V_{REF}$	$V_{REF} \equiv (REF\ IN+) - (REF\ IN-)$	0.1		1.25	V
Common-Mode Rejection	at DC		120		dB
Common-Mode Rejection	$f_{VREFCM} = 60Hz$ , $f_{DATA} = 60Hz$		120		dB
Bias Current <sup>(3)</sup>	$V_{REF} = 1.25V$		0.65		$\mu A$

(1) Calibration can minimize these errors.

(2)  $\Delta V_{OUT}$  is change in digital result.

(3) 12pF switched capacitor at  $f_{SAMP}$  clock frequency.

**ELECTRICAL CHARACTERISTICS: AV<sub>DD</sub> = 3V (continued)**

All specifications T<sub>MIN</sub> to T<sub>MAX</sub>, AV<sub>DD</sub> = +3V, DV<sub>DD</sub> = +2.7V to 5.25V, f<sub>MOD</sub> = 19.2kHz, f<sub>OSC</sub> = 2.4576MHz, PGA = 1, Buffer On, R<sub>DAC</sub> = 75kΩ, V<sub>REF</sub> ≡ (REF IN+) – (REF IN-) = +1.25V, and f<sub>DATA</sub> = 10Hz, unless otherwise specified.

PARAMETER	CONDITIONS	ADS1218			UNIT
		MIN	TYP	MAX	
<b>ON-CHIP VOLTAGE REFERENCE</b>					
Output Voltage	REF HI = 0 at +25°C	1.245	1.25	1.255	V
Short-Circuit Current Source			3		mA
Short-Circuit Current Sink			50		μA
Short-Circuit Duration	Sink or Source		Indefinite		
Drift			5		ppm/°C
Noise	BW = 0.1Hz to 100Hz		10		μV <sub>PP</sub>
Output Impedance	Sourcing 100μA		3		Ω
Startup Time			50		μs
<b>IDAC</b>					
Full-Scale Output Current	R <sub>DAC</sub> = 75kΩ, Range = 1		0.5		mA
	R <sub>DAC</sub> = 75kΩ, Range = 2		1		mA
	R <sub>DAC</sub> = 75kΩ, Range = 3		2		mA
	R <sub>DAC</sub> = 15kΩ, Range = 3		20		mA
Maximum Short-Circuit Current Duration	R <sub>DAC</sub> = 10kΩ R <sub>DAC</sub> = 0Ω		Indefinite	10	Minutes
Monotonicity	R <sub>DAC</sub> = 75kΩ	8			Bits
Compliance Voltage		0		AV <sub>DD</sub> – 1	V
Output Impedance			See Typical Characteristics		
PSRR	V <sub>OUT</sub> = AV <sub>DD</sub> /2		600		ppm/V
Absolute Error	Individual IDAC		5		%
Absolute Drift	Individual IDAC		75		ppm/°C
Mismatch Error	Between IDACs, Same Range and Code		0.25		%
Mismatch Drift	Between IDACs, Same Range and Code		15		ppm/°C
<b>POWER-SUPPLY REQUIREMENTS</b>					
Power-Supply Voltage	AV <sub>DD</sub>	2.7		3.3	V
Analog Current (I <sub>ADC</sub> + I <sub>VREF</sub> + I <sub>DAC</sub> ) ADC Current (I <sub>ADC</sub> )	$\overline{PDWN} = 0$ , or SLEEP		1		nA
	PGA = 1, Buffer Off		160	250	μA
	PGA = 128, Buffer Off		450	700	μA
	PGA = 1, Buffer On		230	325	μA
	PGA = 128, Buffer On		850	1325	μA
V <sub>REF</sub> Current (I <sub>VREF</sub> )			250	375	μA
I <sub>DAC</sub> Current (I <sub>DAC</sub> )	Excludes Load Current		480	675	μA
	Normal Mode, DV <sub>DD</sub> = 3V		90	200	μA
	SLEEP Mode, DV <sub>DD</sub> = 3V		75		μA
	Read Data Continuous Mode, DV <sub>DD</sub> = 3V		113		μA
Digital Current	$\overline{PDWN} = 0$		1		nA
Power Dissipation	PGA = 1, Buffer Off, REFEN = 0, I <sub>DACS</sub> Off, DV <sub>DD</sub> = 3V		0.8	1.4	mW
<b>TEMPERATURE RANGE</b>					
Operating		-40		+85	°C
Storage		-60		+100	°C

**DIGITAL CHARACTERISTICS:  $T_{MIN}$  to  $T_{MAX}$ ,  $DV_{DD} = 2.7V$  to  $5.25V$** 

PARAMETER	CONDITIONS	MIN	TYP	MAX	UNIT
Digital Input/Output					
Logic Family			CMOS		
Logic Level					
$V_{IH}$		$0.8 \times DV_{DD}$		$DV_{DD}$	V
$V_{IL}$		DGND		$0.2 \times DV_{DD}$	V
$V_{OH}$	$I_{OH} = 1mA$	$DV_{DD} - 0.4$			V
$V_{OL}$	$I_{OL} = 1mA$	DGND		$DGND + 0.4$	V
Input Leakage					
$I_{IH}$	$V_I = DV_{DD}$			10	$\mu A$
$I_{IL}$	$V_I = 0$	-10			$\mu A$
Master Clock Rate: $f_{OSC}^{(1)}$		1		5	MHz
Master Clock Period: $t_{OSC}^{(1)}$	$1/f_{OSC}$	200		1000	ns

- (1) For the Write RAM to Flash operation (WR2F), the SPEED bit in the SETUP register must be set appropriately and the device operating frequency must be:  $2.3MHz < f_{OSC} < 4.13MHz$ .

**FLASH CHARACTERISTICS:  $T_{MIN}$  to  $T_{MAX}$ ,  $DV_{DD} = 2.7V$  to  $5.25V$ , unless otherwise specified.**

PARAMETER	CONDITIONS	MIN	TYP	MAX	UNIT
Operating Current					
Page Write	$DV_{DD} = 5V$ , During WR2F Command		17		mA
	$DV_{DD} = 3V$ , During WR2F Command		9		mA
Page Read	$DV_{DD} = 5V$ , During RF2R Command		8		mA
	$DV_{DD} = 3V$ , During RF2R Command		2		mA
Endurance			100,000		Write Cycles
Data Retention	at +25°C	100			Years
$DV_{DD}$ for Erase/Write		2.7		5.25	V

**PIN CONFIGURATION**

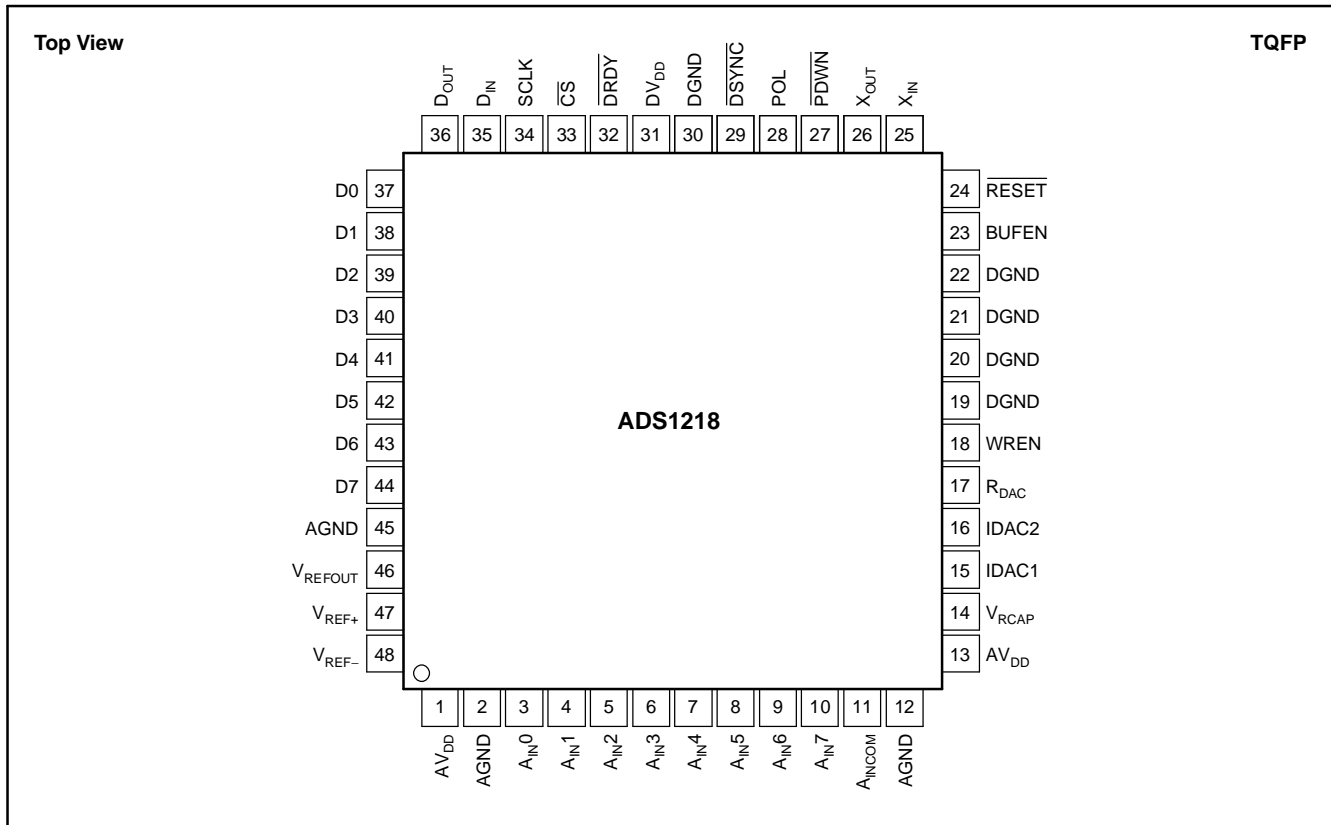

**PIN DESCRIPTIONS**

PIN NUMBER	NAME	DESCRIPTION	PIN NUMBER	NAME	DESCRIPTION
1	AV <sub>DD</sub>	Analog Power Supply	24	<u>RESET</u>	Active Low, resets the entire chip.
2	AGND	Analog Ground	25	X <sub>IN</sub>	Clock Input
3	A <sub>IN0</sub>	Analog Input 0	26	X <sub>OUT</sub>	Clock Output, used with crystal or resonator.
4	A <sub>IN1</sub>	Analog Input 1	27	<u>PDWN</u>	Active Low. Power Down. The power-down function shuts down the analog and digital circuits.
5	A <sub>IN2</sub>	Analog Input 2	28	POL	Serial Clock Polarity
6	A <sub>IN3</sub>	Analog Input 3	29	<u>DSYNC</u>	Active Low, Synchronization Control
7	A <sub>IN4</sub>	Analog Input 4	30	DGND	Digital Ground
8	A <sub>IN5</sub>	Analog Input 5	31	DV <sub>DD</sub>	Digital Power Supply
9	A <sub>IN6</sub>	Analog Input 6	32	<u>DRDY</u>	Active Low, Data Ready
10	A <sub>IN7</sub>	Analog Input 7	33	<u>CS</u>	Active Low, Chip Select
11	A <sub>INCOM</sub>	Analog Input Common	34	SCLK	Serial Clock, Schmitt Trigger
12	AGND	Analog Ground	35	D <sub>IN</sub>	Serial Data Input, Schmitt Trigger
13	AV <sub>DD</sub>	Analog Power Supply	36	D <sub>OUT</sub>	Serial Data Output
14	V <sub>RCAP</sub>	V <sub>REF</sub> Bypass CAP	37–44	D0–D7	Digital I/O 0–7
15	IDAC1	Current DAC1 Output	45	AGND	Analog Ground
16	IDAC2	Current DAC2 Output	46	V <sub>REFOUT</sub>	Voltage Reference Output
17	R <sub>DAC</sub>	Current DAC Resistor	47	V <sub>REF+</sub>	Positive Differential Reference Input
18	WREN	Active High, Flash Write Enable	48	V <sub>REF-</sub>	Negative Differential Reference Input
19–22	DGND	Digital Ground			
23	BUFEN	Buffer Enable			



## TIMING SPECIFICATIONS

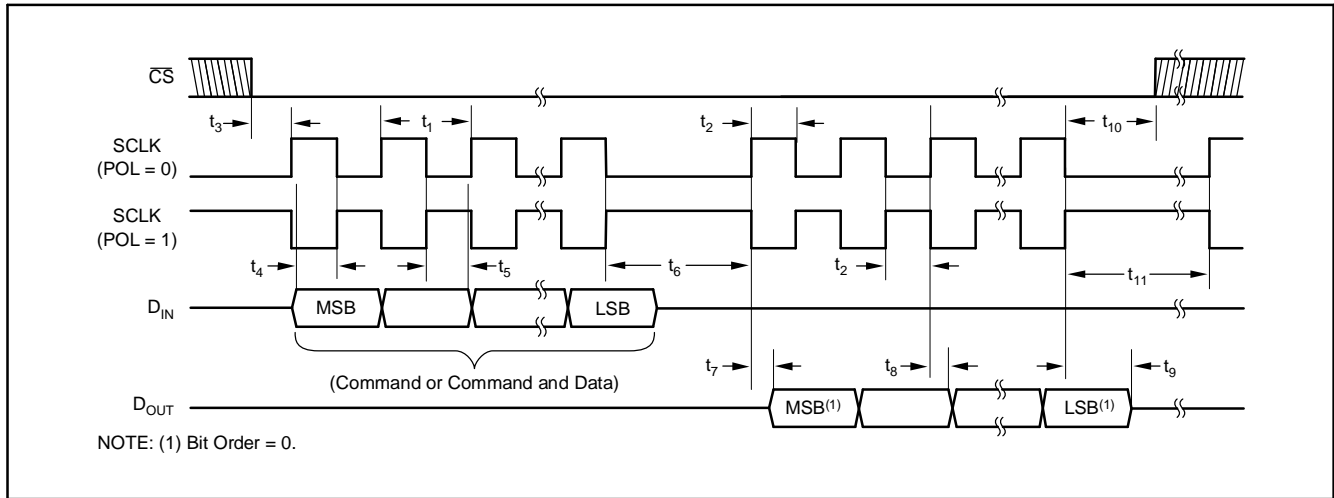

## TIMING SPECIFICATION TABLE

SPEC	DESCRIPTION	MIN	MAX	UNIT
$t_1$	SCLK Period	4	3	$t_{osc}$ Periods DRDY Periods
$t_2$	SCLK Pulse Width, High and Low	200		ns
$t_3$	$\overline{CS}$ Low to first SCLK Edge; Setup Time	0		ns
$t_4$	$D_{IN}$ Valid to SCLK Edge; Setup Time	50		ns
$t_5$	Valid $D_{IN}$ to SCLK Edge; Hold Time	50		ns
$t_6$	Delay between last SCLK edge for $D_{IN}$ and first SCLK edge for $D_{OUT}$ :			
	RDATA, RDATA_C, RREG, WREG, RRAM	50		$t_{osc}$ Periods
	CSREG, CSRAMX, CSRAM	200		$t_{osc}$ Periods
	CSARAM, CSARAMX	1100		$t_{osc}$ Periods
$t_7^{(1)}$	SCLK Edge to Valid New $D_{OUT}$		50	ns
$t_8^{(1)}$	SCLK Edge to $D_{OUT}$ , Hold Time	0		ns
$t_9$	Last SCLK Edge to $D_{OUT}$ Tri-State NOTE: $D_{OUT}$ goes tri-state immediately when $\overline{CS}$ goes High.	6	10	$t_{osc}$ Periods
$t_{10}$	$\overline{CS}$ Low time after final SCLK edge	0		ns
$t_{11}$	Final SCLK edge of one op code until first edge SCLK of next command:			
	RREG, WREG, RRAM, WRAM, CSRAMX, CSARAMX, CSRAM, CSARAM, CSREG, SLEEP, RDATA, RDATA_C, STOPC	4		$t_{osc}$ Periods
	DSYNC	16		$t_{osc}$ Periods
	CSFL	33,000		$t_{osc}$ Periods
	CREG, CRAM	220		$t_{osc}$ Periods
	RF2R	1090		$t_{osc}$ Periods
	CREGA	1600		$t_{osc}$ Periods
	WR2F	76,850 (SPEED = 0) 101,050 (SPEED = 1)		$t_{osc}$ Periods
	SELFGCAL, SELFOCAL, SYSOCAL, SYSGCAL	7	4	$t_{osc}$ Periods DRDY Periods
	SELFICAL	14		DRDY Periods
	RESET (Command, SCLK, or Pin)	2640		$t_{osc}$ Periods

(1) Load = 20pF || 10kΩ to DGND.

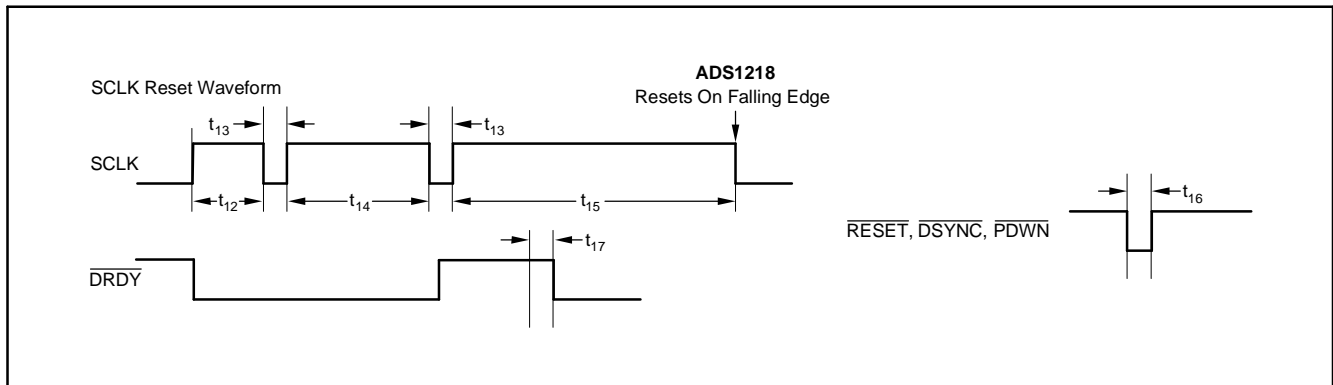

**TIMING SPECIFICATION TABLE**

SPEC	DESCRIPTION	MIN	MAX	UNIT
$t_{12}$	SCLK Reset, First High Pulse	300	500	$t_{\text{osc}}$ Periods
$t_{13}$	SCLK Reset, Low Pulse	5		$t_{\text{osc}}$ Periods
$t_{14}$	SCLK Reset, Second High Pulse	550	750	$t_{\text{osc}}$ Periods
$t_{15}$	SCLK Reset, Third High Pulse	1050	1250	$t_{\text{osc}}$ Periods
$t_{16}$	Pulse Width	4		$t_{\text{osc}}$ Periods
$t_{17}$	Data Not Valid During this Update Period	4		$t_{\text{osc}}$ Periods

**TYPICAL CHARACTERISTICS**

$A_{V_{DD}} = +5V$ ,  $DV_{DD} = +5V$ ,  $f_{OSC} = 2.4576MHz$ ,  $PGA = 1$ ,  $R_{DAC} = 150k\Omega$ ,  $V_{REF} \equiv (REF\ IN+) - (REF\ IN-) = +2.5V$ , and  $f_{DATA} = 10Hz$ , unless otherwise specified.

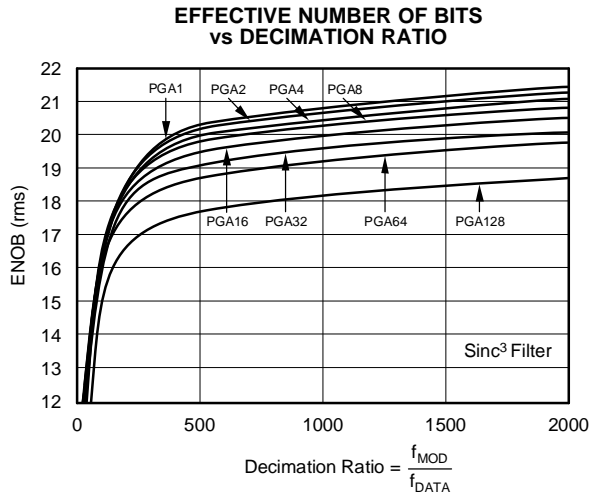

Figure 1.

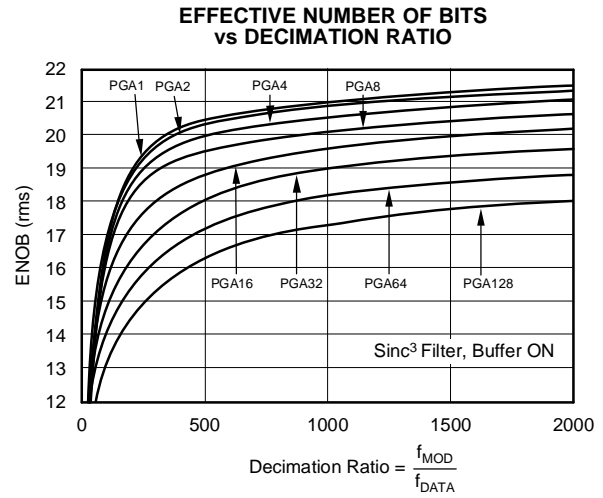

Figure 2.

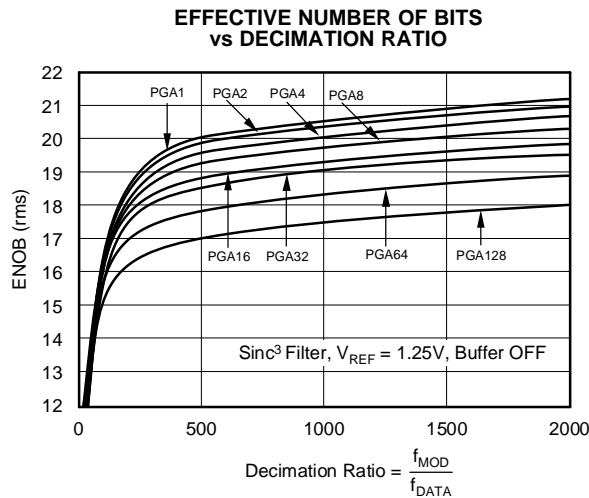

Figure 3.

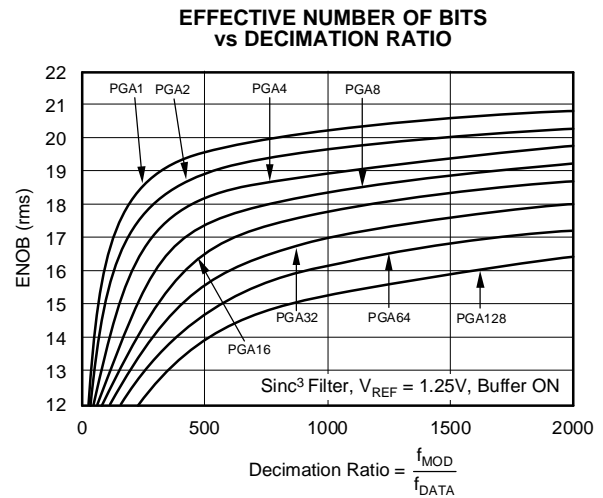

Figure 4.

**TYPICAL CHARACTERISTICS (continued)**

$A_{V_{DD}} = +5V$ ,  $DV_{DD} = +5V$ ,  $f_{OSC} = 2.4576MHz$ ,  $PGA = 1$ ,  $R_{DAC} = 150k\Omega$ ,  $V_{REF} \equiv (REF\ IN+) - (REF\ IN-) = +2.5V$ , and  $f_{DATA} = 10Hz$ , unless otherwise specified.

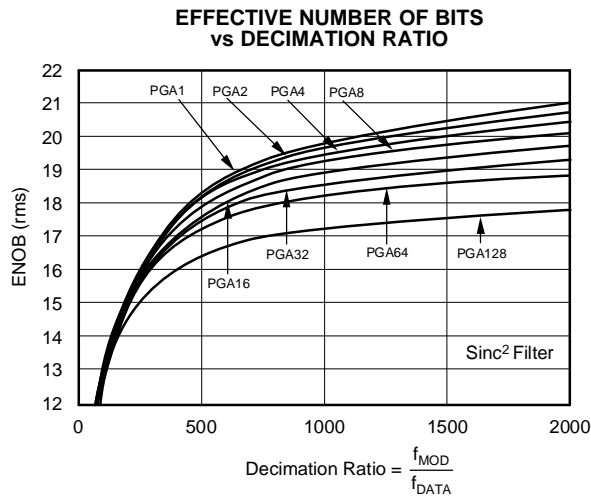

Figure 5.

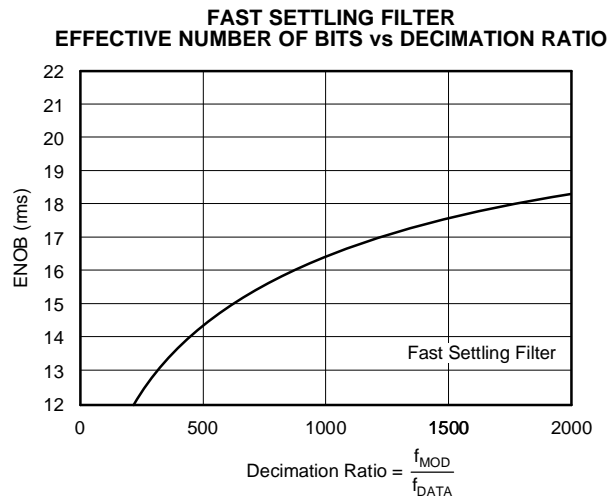

Figure 6.

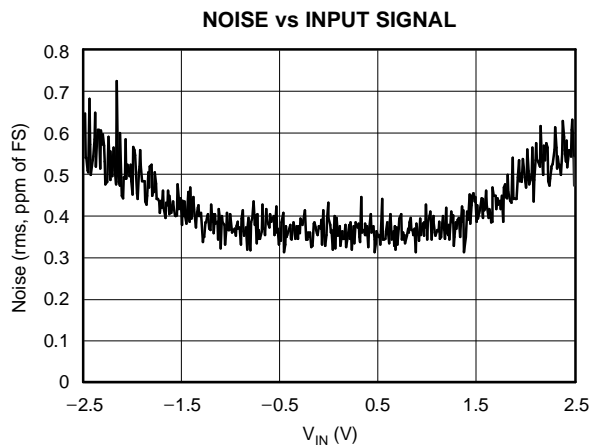

Figure 7.

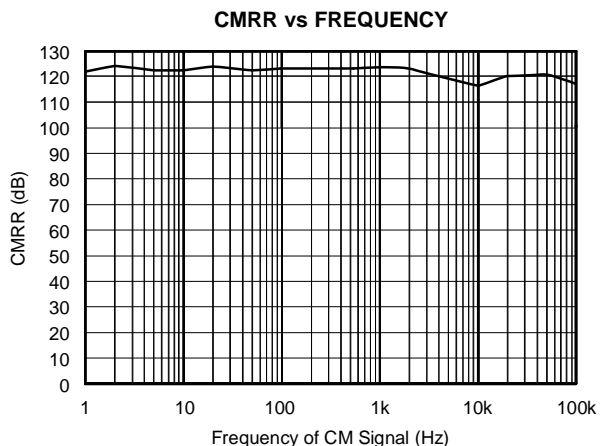

Figure 8.

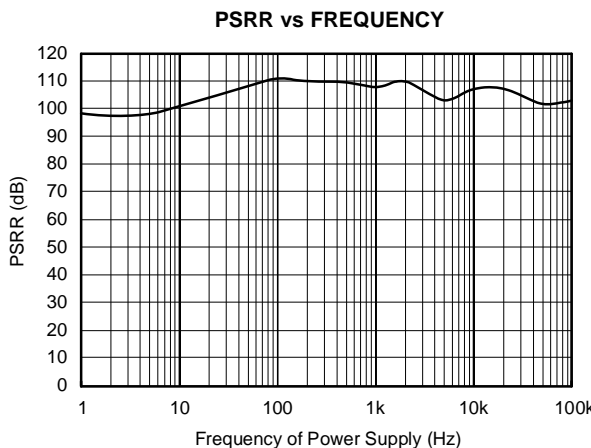

Figure 9.

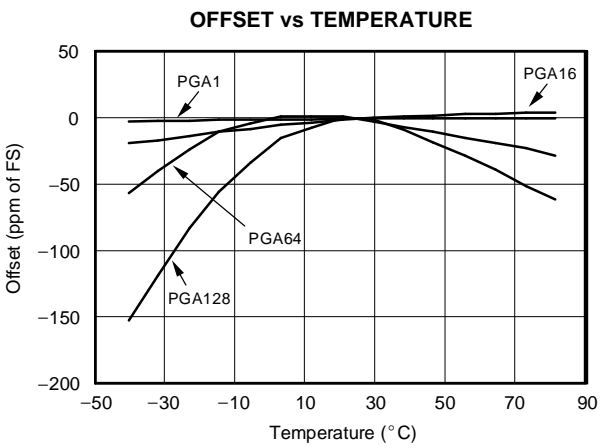

Figure 10.

**TYPICAL CHARACTERISTICS (continued)**

$V_{DD} = +5V$ ,  $DV_{DD} = +5V$ ,  $f_{OSC} = 2.4576MHz$ ,  $PGA = 1$ ,  $R_{DAC} = 150k\Omega$ ,  $V_{REF} \equiv (REF\ IN+) - (REF\ IN-) = +2.5V$ , and  $f_{DATA} = 10Hz$ , unless otherwise specified.

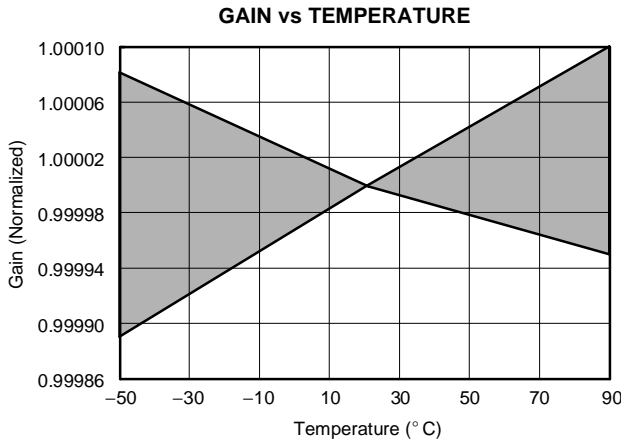

Figure 11.

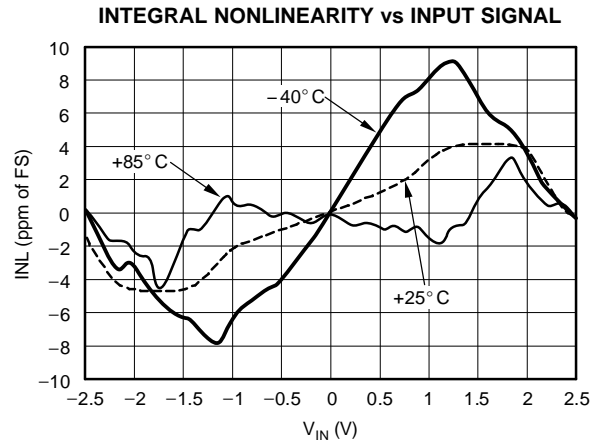

Figure 12.

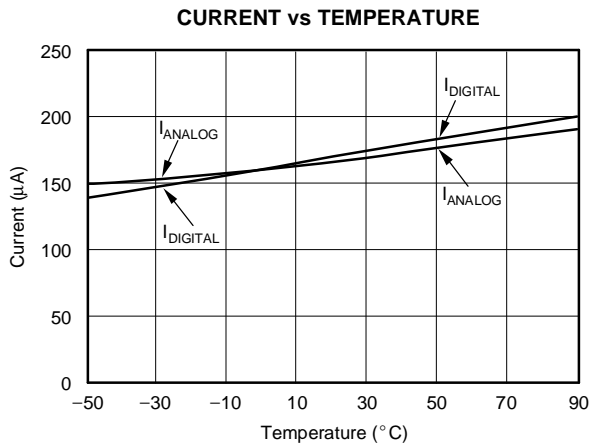

Figure 13.

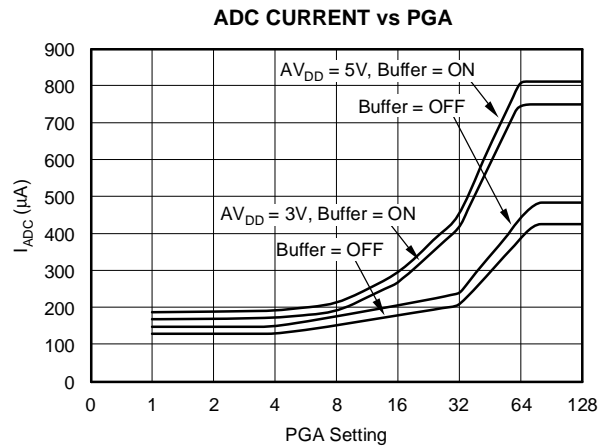

Figure 14.

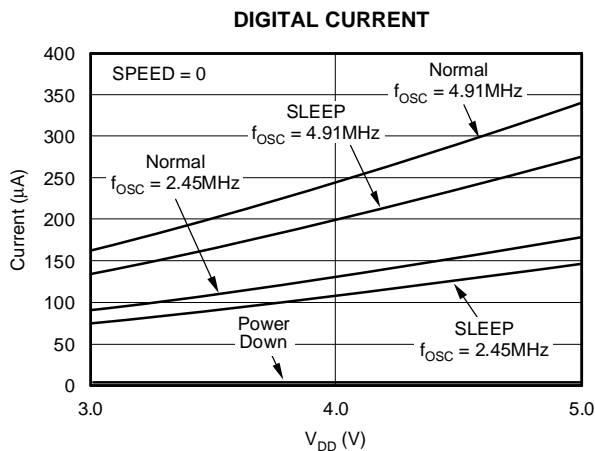

Figure 15.

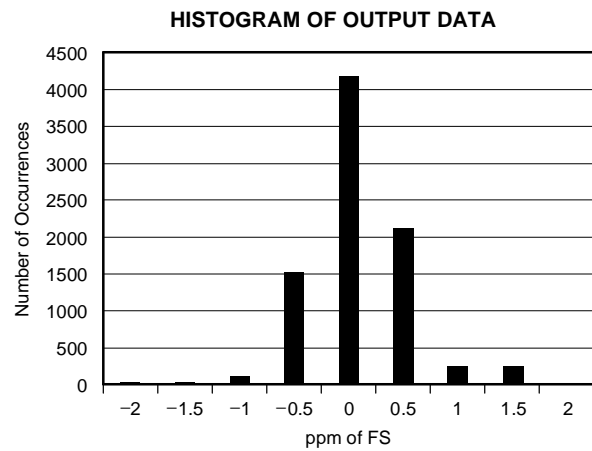

Figure 16.

**TYPICAL CHARACTERISTICS (continued)**

$V_{DD} = +5V$ ,  $DV_{DD} = +5V$ ,  $f_{OSC} = 2.4576MHz$ ,  $PGA = 1$ ,  $R_{DAC} = 150k\Omega$ ,  $V_{REF} \equiv (REF\ IN+) - (REF\ IN-) = +2.5V$ , and  $f_{DATA} = 10Hz$ , unless otherwise specified.

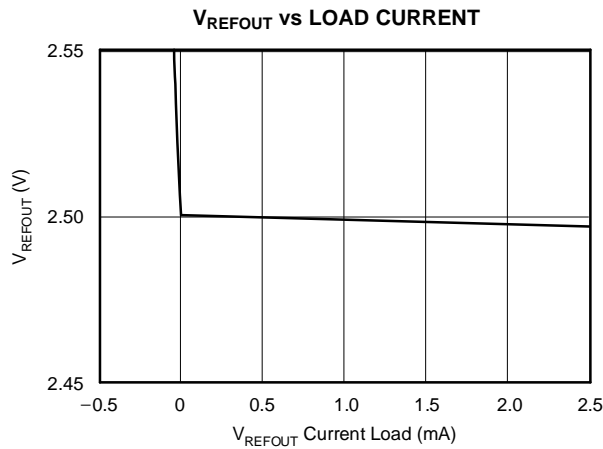

Figure 17.

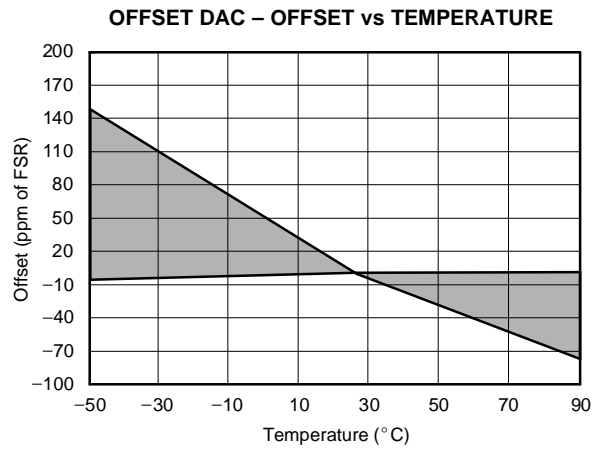

Figure 18.

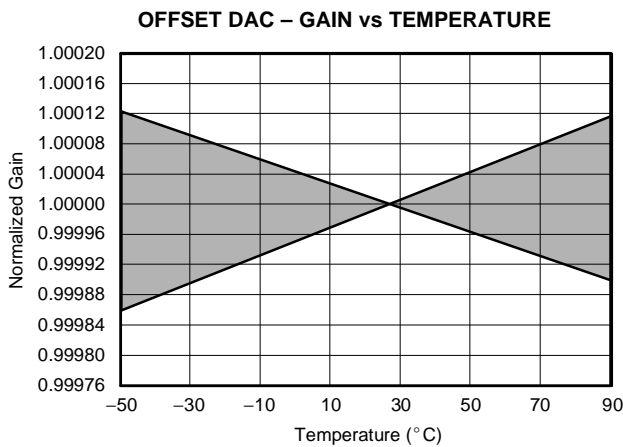

Figure 19.

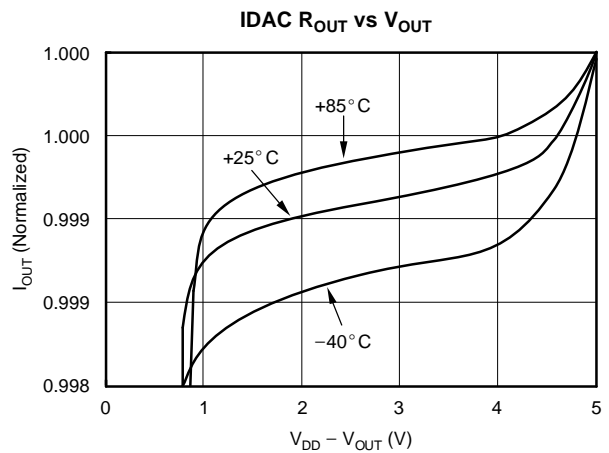

Figure 20.

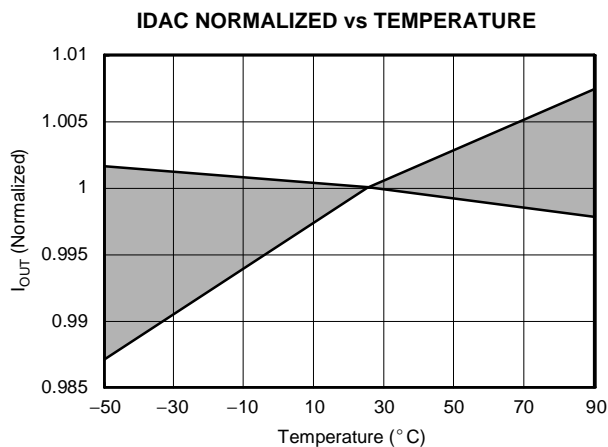

Figure 21.

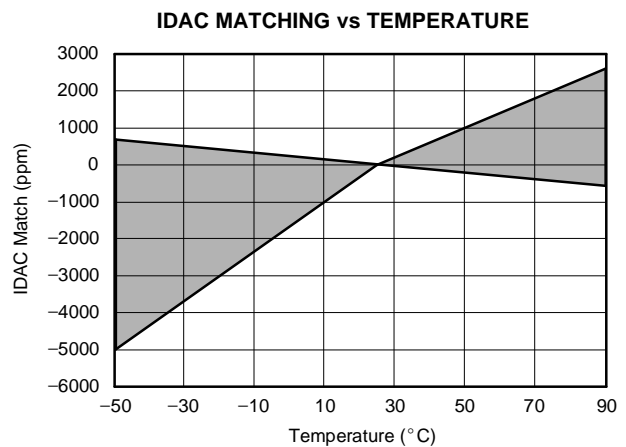
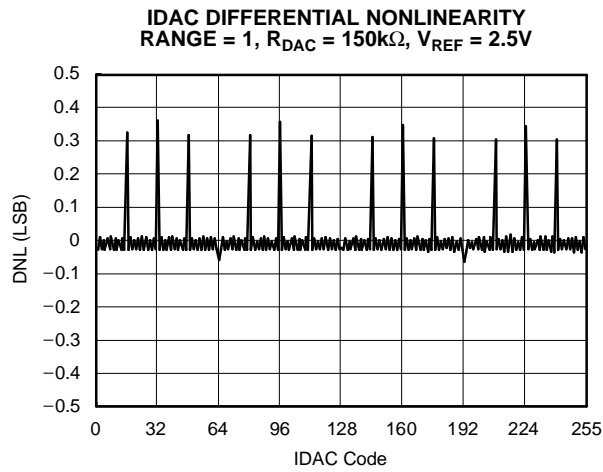

Figure 22.

**TYPICAL CHARACTERISTICS (continued)**

$A_{V_{DD}} = +5V$ ,  $DV_{DD} = +5V$ ,  $f_{OSC} = 2.4576MHz$ ,  $PGA = 1$ ,  $R_{DAC} = 150k\Omega$ ,  $V_{REF} \equiv (REF\ IN+) - (REF\ IN-) = +2.5V$ , and  $f_{DATA} = 10Hz$ , unless otherwise specified.



**Figure 23.**

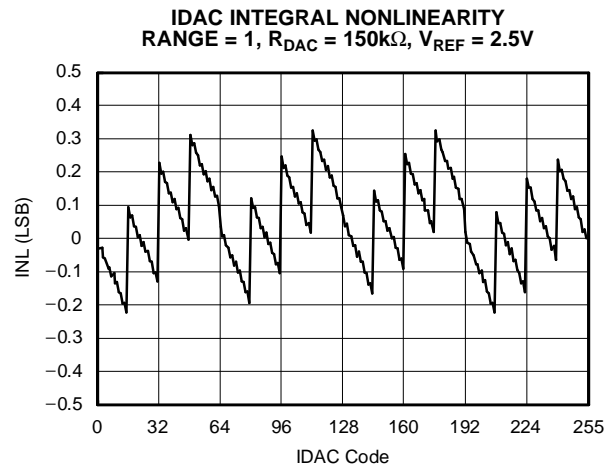

**Figure 24.**

## OVERVIEW

### INPUT MULTIPLEXER

The input multiplexer provides for any combination of differential inputs to be selected on any of the input channels, as shown in Figure 25. For example, if channel 1 is selected as the positive differential input channel, any other channel can be selected as the negative differential input channel. With this method, it is possible to have up to eight fully differential input channels.

In addition, current sources are supplied that will source or sink current to detect open or short circuits on the input pins.

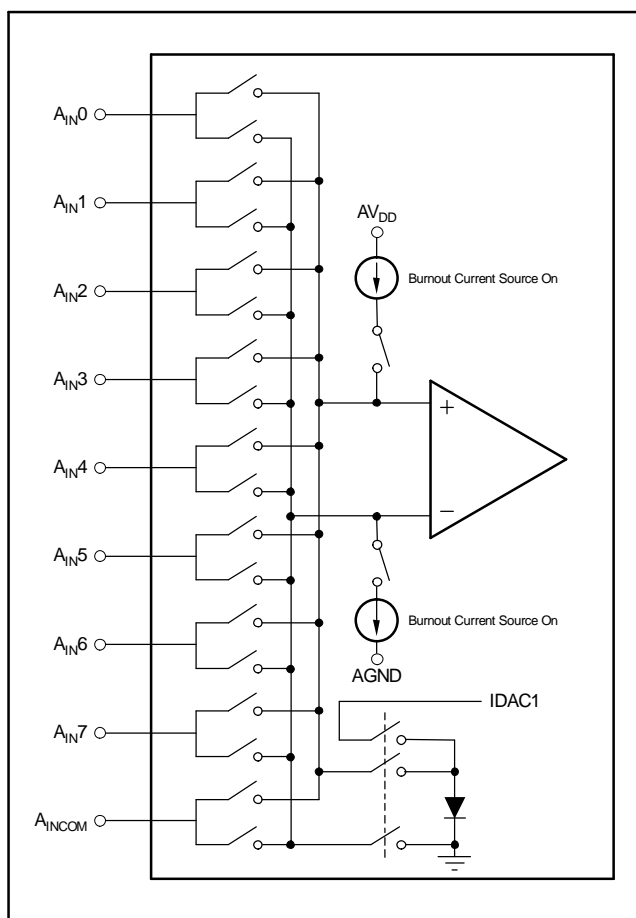

Figure 25. Input Multiplexer Configuration

### TEMPERATURE SENSOR

An on-chip diode provides temperature sensing capability. When the configuration register for the input MUX is set to all 1s, the diode is connected to the input of the A/D converter. All other channels are

open. The anode of the diode is connected to the positive input of the A/D converter, and the cathode of the diode is connected to negative input of the A/D converter. The output of IDAC1 is connected to the anode to bias the diode and the cathode of the diode is also connected to ground to complete the circuit.

In this mode, the output of IDAC1 is also connected to the output pin, so some current may flow into an external load from IDAC1, rather than the diode. See Application Report *Measuring Temperature with the ADS1256, ADS1217, or ADS1218 (SBAA073)* for more information.

### BURNOUT CURRENT SOURCES

When the Burnout bit is set in the ACR configuration register, two current sources are enabled. The current source on the positive input channel sources approximately 2µA of current. The current source on the negative input channel sinks approximately 2µA. This allows for the detection of an open circuit (full-scale reading) or short circuit (0V differential reading) on the selected input differential pair.

### INPUT BUFFER

The input impedance of the ADS1218 without the buffer is 5MΩ/PGA. With the buffer enabled, the input voltage range is reduced and the analog power-supply current is higher. The buffer is controlled by ANDing the state of the BUFEN pin with the state of the BUFFER bit in the ACR register. See Application Report *Input Currents for High-Resolution ADCs (SBAA090)* for more information.

### IDAC1 AND IDAC2

The ADS1218 has two 8-bit current output DACs that can be controlled independently. The output current is set with  $R_{DAC}$ , the range select bits in the ACR register, and the 8-bit digital value in the IDAC register.

The output current =  $V_{REF}/(8R_{DAC})(2^{RANGE-1})(DAC\ CODE)$ . With  $V_{REFOUT} = 2.5V$  and  $R_{DAC} = 150k\Omega$  to AGND the full-scale output can be selected to be 0.5mA, 1mA, or 2mA. The compliance voltage range is 0V to within 1V of  $AV_{DD}$ . When the internal voltage reference of the ADS1218 is used, it is the reference for the IDAC. An external reference may be used for the IDACs by disabling the internal reference and tying the external reference input to the  $V_{REFOUT}$  pin.



## PGA

The Programmable Gain Amplifier (PGA) can be set to gains of 1, 2, 4, 8, 16, 32, 64, or 128. Using the PGA can improve the effective resolution of the A/D converter. For instance, with a PGA of 1 on a 5V full-scale range, the A/D converter can resolve to 1 $\mu$ V. With a PGA of 128, on a 40mV full-scale range, the A/D converter can resolve to 75nV.

## PGA OFFSET DAC

The input to the PGA can be shifted by half the full-scale input range of the PGA by using the ODAC register. The ODAC (Offset DAC) register is an 8-bit value; the MSB is the sign and the seven LSBs provide the magnitude of the offset. Using the ODAC register does not reduce the performance of the A/D converter. See Application Report *The Offset DAC* (SBAA077) for more information.

## MODULATOR

The modulator is a single-loop second-order system. The modulator runs at a clock speed ( $f_{MOD}$ ) that is derived from the external clock ( $f_{OSC}$ ). The frequency division is determined by the SPEED bit in the SETUP register.

SPEED BIT	$f_{MOD}$
0	$f_{OSC}/128$
1	$f_{OSC}/256$

## VOLTAGE REFERENCE INPUT

The ADS1218 uses a differential voltage reference input. The input signal is measured against the differential voltage  $V_{REF} \equiv (V_{REF+}) - (V_{REF-})$ . For  $AV_{DD} = 5V$ ,  $V_{REF}$  is typically 2.5V. For  $AV_{DD} = 3V$ ,  $V_{REF}$  is typically 1.25V. Due to the sampling nature of the modulator, the reference input current increases with higher modulator clock frequency ( $f_{MOD}$ ) and higher PGA settings.

## ON-CHIP VOLTAGE REFERENCE

A selectable voltage reference (1.25V or 2.5V) is available for supplying the voltage reference input. To use, connect  $V_{REF-}$  to AGND and  $V_{REF+}$  to  $V_{REFOUT}$ . The enabling and voltage selection are controlled through bits REF EN and REF HI in the setup register. The 2.5V reference requires  $AV_{DD} = 5V$ . When using the on-chip voltage reference, the  $V_{REFOUT}$  pin should be bypassed with a 0.1 $\mu$ F capacitor to AGND.

## $V_{RCAP}$ PIN

This pin provides a bypass cap for noise filtering on internal  $V_{REF}$  circuitry only. As this is a sensitive pin, place the capacitor as close as possible and avoid any resistive loading. The recommended capacitor is a 1000pF ceramic cap. If an external  $V_{REF}$  is used, this pin can be left unconnected.

## CLOCK GENERATOR

The clock source for the ADS1218 can be provided from a crystal, oscillator, or external clock. When the clock source is a crystal, external capacitors must be provided to ensure startup and a stable clock frequency; see Figure 26 and Table 1.

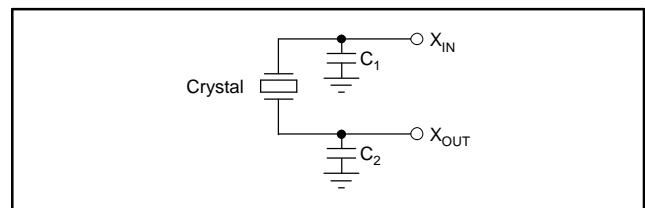

Figure 26. Crystal Connection

Table 1. Typical Clock Sources

CLOCK SOURCE	FREQUENCY	C <sub>1</sub>	C <sub>2</sub>	PART NUMBER
Crystal	2.4576	0-20pF	0-20pF	ECS, ECSD 2.45 - 32
Crystal	4.9152	0-20pF	0-20pF	ECS, ECLS 4.91
Crystal	4.9152	0-20pF	0-20pF	ECS, ECSD 4.91
Crystal	4.9152	0-20pF	0-20pF	CTS, MP 042 4M9182

## CALIBRATION

The offset and gain errors in the ADS1218, or the complete system, can be reduced with calibration. Internal calibration of the ADS1218 is called self calibration. This is handled with three commands. One command does both offset and gain calibration. There is also a gain calibration command and an offset calibration command. Each calibration process takes seven  $t_{DATA}$  periods to complete. It takes 14  $t_{DATA}$  periods to complete both an offset and gain calibration. Self-gain calibration is optimized for PGA gains less than 8. When using higher gains, system gain calibration is recommended.

For system calibration, the appropriate signal must be applied to the inputs. The system offset command requires a *zero* differential input signal. It then computes an offset that will nullify offset in the system. The system gain command requires a positive *full-scale* differential input signal. It then computes a value to nullify gain errors in the system. Each of these calibrations will take seven  $t_{DATA}$  periods to complete.

Calibration must be performed after power on, a change in decimation ratio, or a change of the PGA. For operation with a reference voltage greater than ( $V_{DD} - 1.5V$ ), the buffer must also be turned off during calibration.

At the completion of calibration, the  $\overline{DRDY}$  signal goes low, which indicates the calibration is finished and valid data is available. See Application Report *Calibration Routine and Register Value Generation for the ADS121x Series (SBAA099)* for more information.

**DIGITAL FILTER**

The Digital Filter can use either the fast settling, sinc<sup>2</sup>, or sinc<sup>3</sup> filter, as shown in Figure 27. In addition, the Auto mode changes the sinc filter after the input channel or PGA is changed. When switching to a new channel, it will use the fast settling filter for the next two conversions, the first of which should be discarded. It will then use the sinc<sup>2</sup> followed by the sinc<sup>3</sup> filter. This combines the low-noise advantage of the sinc<sup>3</sup> filter with the quick response of the fast settling time filter. See Figure 28 for the frequency response of each filter.

When using the fast setting filter, select a decimation value set by the DEC0 and M/DEC1 registers that is evenly divisible by four for the best gain accuracy. For example, choose 260 rather than 261.

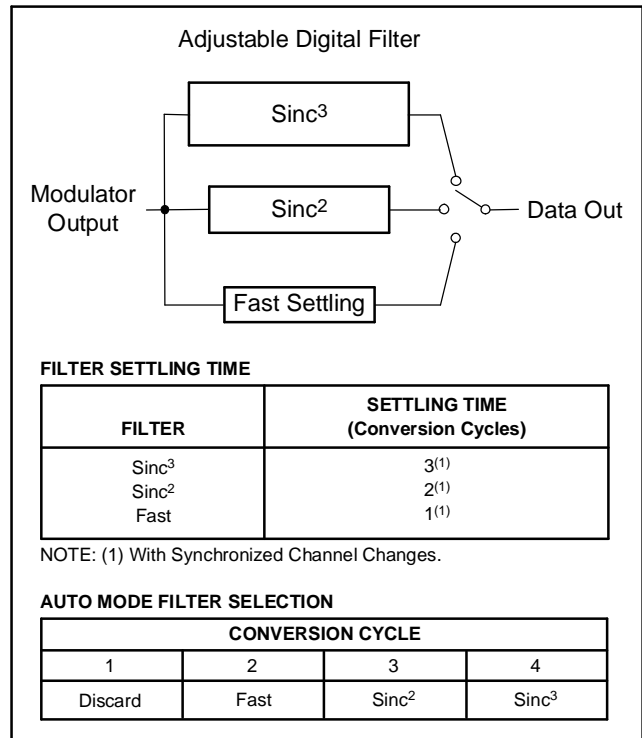

**Figure 27. Filter Step Responses**

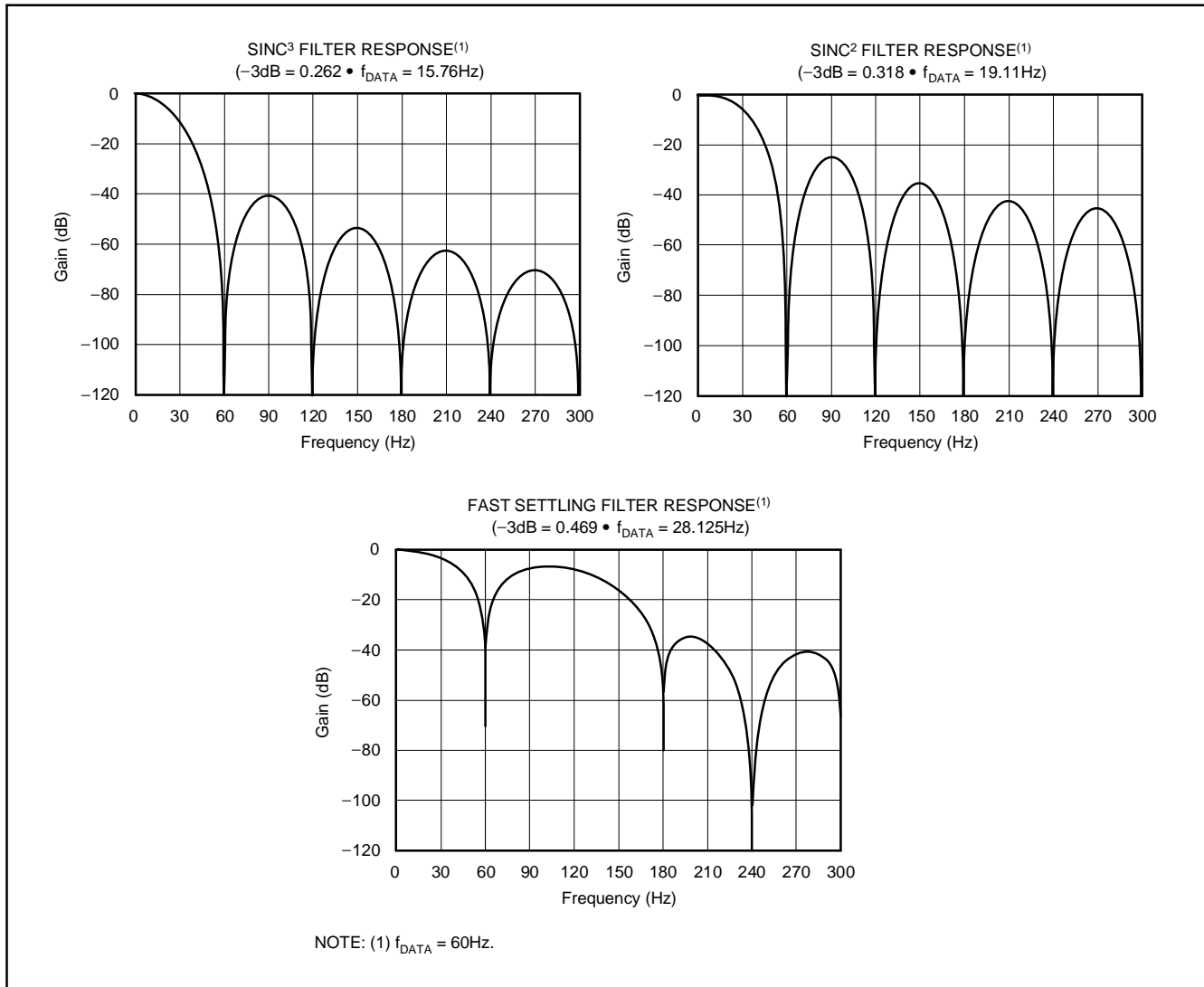

**Figure 28. Filter Frequency Responses**

## DIGITAL I/O INTERFACE

The ADS1218 has eight pins dedicated for digital I/O. The default power-up condition for the digital I/O pins are as inputs. All of the digital I/O pins are individually configurable as inputs or outputs. They are configured through the DIR control register. The DIR register defines whether the pin is an input or output, and the DIO register defines the state of the digital output. When the digital I/O are configured as inputs, DIO is used to read the state of the pin. If the digital I/O are not used, either 1) configure as outputs; or 2) leave as inputs and tie to ground; this prevents excess power dissipation.

## SERIAL PERIPHERAL INTERFACE

The Serial Peripheral Interface (SPI) allows a controller to communicate synchronously with the ADS1218. The ADS1218 operates in slave-only mode.

### Chip Select ( $\overline{CS}$ )

The chip select ( $\overline{CS}$ ) input of the ADS1218 must be externally asserted before a master device can exchange data with the ADS1218.  $\overline{CS}$  must be low for the duration of the transaction.  $\overline{CS}$  can be tied low.

**Serial Clock (SCLK)**

SCLK, a Schmitt Trigger input, clocks data transfer on the D<sub>IN</sub> input and D<sub>OUT</sub> output. When transferring data to or from the ADS1218, multiple bits of data may be transferred back-to-back with no delay in SCLKs or toggling of  $\overline{CS}$ . Make sure to avoid glitches on SCLK because they can cause extra shifting of the data.

**Polarity (POL)**

The serial clock polarity is specified by the POL input. When SCLK is active high, set POL high. When SCLK is active low, set POL low.

**DATA READY**

The  $\overline{DRDY}$  output is used as a status signal to indicate when data is ready to be read from the ADS1218.  $\overline{DRDY}$  goes low when new data is available. It is reset high when a read operation from the data register is complete. It also goes high prior to the updating of the output register to indicate when not to read from the device to ensure that a data read is not attempted while the register is being updated.

**DSYNC OPERATION**

DSYNC is used to provide for synchronization of the A/D conversion with an external event. Synchronization can be achieved either through the  $\overline{DSYNC}$  pin or the DSYNC command. When the  $\overline{DSYNC}$  pin is used, the filter counter is reset on the falling edge of  $\overline{DSYNC}$ . The modulator is held in reset until  $\overline{DSYNC}$  is taken high. Synchronization occurs on the next rising edge of the system clock after  $\overline{DSYNC}$  is taken high.

**MEMORY**

Three types of memory are used on the ADS1218: registers, RAM, and Flash. 16 registers directly control the various functions (PGA, DAC value, Decimation Ratio, etc.) and can be directly read or written to. Collectively, the registers contain all the information needed to configure the part, such as data format, mux settings, calibration settings, decimation ratio, etc. Additional registers, such as conversion data, are accessed through dedicated instructions.

The on-chip Flash can be used to store non-volatile data. The Flash data is separate from the configuration registers and therefore can be used for any purpose, in addition to device configuration. The Flash page data is read and written in 128 byte blocks through the RAM banks; for example, all RAM banks map to a single page of Flash, as shown in Figure 29.

**REGISTER BANK**

The operation of the device is set up through individual registers. The set of the 16 registers required to configure the device is referred to as a Register Bank, as shown in Figure 29.

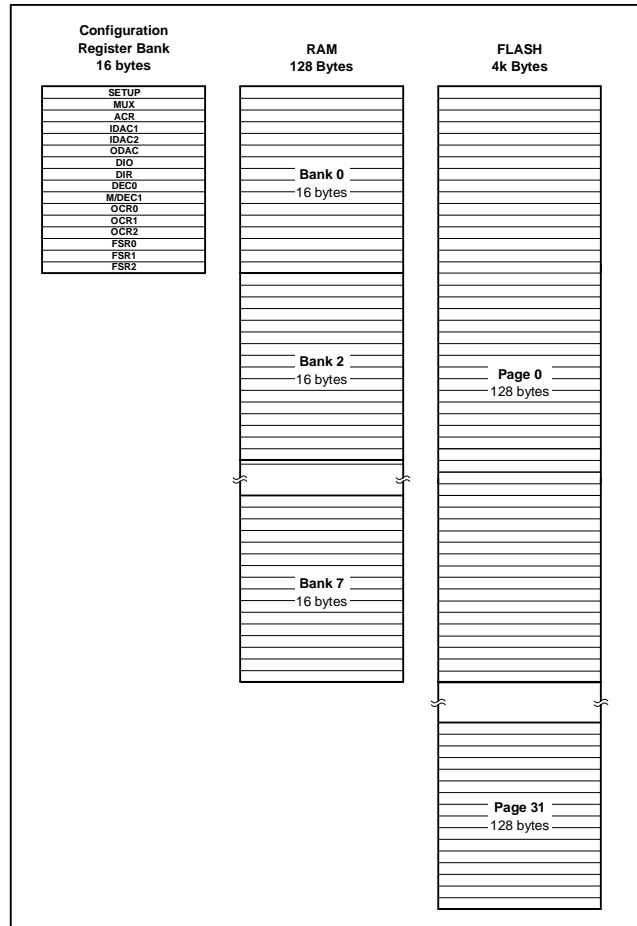

**Figure 29. Memory Organization**

**RAM**

Reads and Writes to Registers and RAM occur on a byte basis. However, copies between registers and RAM occurs on a bank basis. The RAM is independent of the Registers; for example, the RAM can be used as general-purpose RAM.

The ADS1218 supports any combination of eight analog inputs. With this flexibility, the device could easily support eight unique configurations—one per input channel. In order to facilitate this type of usage, eight separate register banks are available. Therefore, each configuration could be written once and recalled as needed without having to serially retransmit all the configuration data. Checksum commands are also included, which can be used to verify the integrity of RAM.

The RAM provides eight *banks*, with a bank consisting of 16 bytes. The total size of the RAM is 128 bytes. Copies between the registers and RAM are performed on a bank basis. Also, the RAM can be directly read or written through the serial interface on power-up. The banks allow separate storage of settings for each input.

The RAM address space is linear; therefore, accessing RAM is done using an auto-incrementing pointer. Access to RAM in the entire memory map can be done consecutively without having to address each bank individually. For example, if you were currently accessing bank 0 at offset 0xF (the last location of bank 0), the next access would be bank 1 and offset 0x0. Any access after bank 7 and offset 0xF will wrap around to bank 0 and Offset 0x0.

Although the Register Bank memory is linear, the concept of addressing the device can also be thought of in terms of bank and offset addressing. Looking at linear and bank addressing syntax, we have the following comparison: in the linear memory map, the address 0x14 is equivalent to bank 1 and offset 0x4. Simply stated, the most significant four bits represent the bank, and the least significant four bits represent the offset. The offset is equivalent to the register address for that bank of memory.

## FLASH

Reads and Writes to Flash occur on a Page basis. Therefore, the entire contents of RAM is used for both Read and Write operations. The Flash is independent of the Registers; for example, the Flash can be used as general-purpose Flash.

Upon power-up or reset, the contents of Flash Page 0 are loaded into RAM. Subsequently, the contents of RAM Bank 0 are loaded into the configuration register. Therefore, the user can customize the power-up configuration for the device. Care should be taken to ensure that data for Flash Page 0 is written correctly, in order to prevent unexpected operation upon power-up.

The ADS1218 supports any combination of eight analog inputs and the Flash memory supports up to 32 unique Page configurations. With this flexibility, the device could support 32 unique configurations for each of the eight analog input channels. For instance, the on-chip temperature sensor could be used to monitor temperature, then different calibration coefficients could be recalled for each of the eight analog input channels based on the change in temperature. This would enable the user to recall calibration coefficients for every 4°C change in temperature over the industrial temperature range, which could be used to correct for drift errors. Checksum commands are also included, which can be used to verify the integrity of Flash.

The following two commands can be used to manipulate the Flash. First, the contents of Flash can be written to with the WR2F (write RAM to Flash) command. This command first erases the designated Flash page and then writes the entire content of RAM (all banks) into the designated Flash page. Second, the contents of Flash can be read with the RF2R (read Flash to RAM) command. This command reads the designated Flash page into the entire contents of RAM (all banks). In order to ensure maximum endurance and data retention, the SPEED bit in the SETUP register must be set for the appropriate  $f_{osc}$  frequency.

Writing to or erasing Flash can be disabled either through the WREN pin or the WREN register bit. If the WREN pin is low OR the WREN bit is cleared, then the WR2F command has no effect. This protects the integrity of the Flash data from being inadvertently corrupted.

Accessing the Flash data either through read, write, or erase may affect the accuracy of the conversion result. Therefore, the conversion result should be discarded when accesses to Flash are done.

**REGISTER MAP**

**Table 2. Registers**

ADDRESS	REGISTER	BIT 7	BIT 6	BIT 5	BIT 4	BIT 3	BIT 2	BIT 1	BIT 0
00 <sub>H</sub>	SETUP	ID	ID	ID	SPEED	REF EN	REF HI	BUF EN	BIT ORDER
01 <sub>H</sub>	MUX	PSEL3	PSEL2	PSEL1	PSEL0	NSEL3	NSEL2	NSEL1	NSEL0
02 <sub>H</sub>	ACR	BOCS	IDAC2R1	IDAC2R0	IDAC1R1	IDAC1R0	PGA2	PGA1	PGA0
03 <sub>H</sub>	IDAC1	IDAC1_7	IDAC1_6	IDAC1_5	IDAC1_4	IDAC1_3	IDAC1_2	IDAC1_1	IDAC1_0
04 <sub>H</sub>	IDAC2	IDAC2_7	IDAC2_6	IDAC2_5	IDAC2_4	IDAC2_3	IDAC2_2	IDAC2_1	IDAC2_0
05 <sub>H</sub>	ODAC	SIGN	OSET_6	OSET_5	OSET_4	OSET_3	OSET_2	OSET_1	OSET_0
06 <sub>H</sub>	DIO	DIO_7	DIO_6	DIO_5	DIO_4	DIO_3	DIO_2	DIO_1	DIO_0
07 <sub>H</sub>	DIR	DIR_7	DIR_6	DIR_5	DIR_4	DIR_3	DIR_2	DIR_1	DIR_0
08 <sub>H</sub>	DEC0	DEC07	DEC06	DEC05	DEC04	DEC03	DEC02	DEC01	DEC00
09 <sub>H</sub>	M/DEC1	DRDY	U/B	SMODE1	SMODE0	WREN	DEC10	DEC9	DEC8
0A <sub>H</sub>	OCR0	OCR07	OCR06	OCR05	OCR04	OCR03	OCR02	OCR01	OCR00
0B <sub>H</sub>	OCR1	OCR15	OCR14	OCR13	OCR12	OCR11	OCR10	OCR09	OCR08
0C <sub>H</sub>	OCR2	OCR23	OCR22	OCR21	OCR20	OCR19	OCR18	OCR17	OCR16
0D <sub>H</sub>	FSR0	FSR07	FSR06	FSR05	FSR04	FSR03	FSR02	FSR01	FSR00
0E <sub>H</sub>	FSR1	FSR15	FSR14	FSR13	FSR12	FSR11	FSR10	FSR09	FSR08
0F <sub>H</sub>	FSR2	FSR23	FSR22	FSR21	FSR20	FSR19	FSR18	FSR17	FSR16

**DETAILED REGISTER DEFINITIONS**

**SETUP** (Address 00<sub>H</sub>) Setup Register

Reset value is set by Flash memory page 0. Factory programmed to iii01110.

bit 7	bit 6	bit 5	bit 4	bit 3	bit 2	bit 1	bit 0
ID	ID	ID	SPEED	REF EN	REF HI	BUF EN	BIT ORDER

bits 7-5 Factory Programmed Bits

bit 4 SPEED: Modulator Clock Speed

0 :  $f_{MOD} = f_{OSC}/128$

1 :  $f_{MOD} = f_{OSC}/256$

NOTE: When writing to Flash memory using the WR2F command, SPEED must be set as follows:

$2.30\text{MHz} < f_{OSC} < 3.12\text{MHz} \rightarrow \text{SPEED} = 0$

$3.13\text{MHz} < f_{OSC} < 4.12\text{MHz} \rightarrow \text{SPEED} = 1$

bit 3 REF EN: Internal Voltage Reference Enable

0 = Internal Voltage Reference Disabled

1 = Internal Voltage Reference Enabled

bit 2 REF HI: Internal Reference Voltage Select

0 = Internal Reference Voltage = 1.25V

1 = Internal Reference Voltage = 2.5V

bit 1 BUF EN: Buffer Enable

0 = Buffer Disabled

1 = Buffer Enabled

bit 0 BIT ORDER: Set Order Bits are Transmitted

0 = Most Significant Bit Transmitted First

1 = Least Significant Bit Transmitted First Data is always shifted into the part most significant bit first.

Data is always shifted out of the part most significant byte first. This configuration bit only controls the bit order within the byte of data that is shifted out.

**MUX** (Address 01<sub>H</sub>) Multiplexer Control Register

Reset value is set by Flash memory page 0. Factory programmed to 01<sub>H</sub>.

bit 7	bit 6	bit 5	bit 4	bit 3	bit 2	bit 1	bit 0
PSEL3	PSEL2	PSEL1	PSEL0	NSEL3	NSEL2	NSEL1	NSEL0

bits 7-4 PSEL3: PSEL2: PSEL1: PSEL0: Positive Channel Select

0000 = A <sub>IN0</sub>	0100 = A <sub>IN4</sub>
0001 = A <sub>IN1</sub>	0101 = A <sub>IN5</sub>
0010 = A <sub>IN2</sub>	0110 = A <sub>IN6</sub>
0011 = A <sub>IN3</sub>	0111 = A <sub>IN7</sub>
1xxx = A <sub>INCOM</sub> (except when all bits are 1s)	
1111 = Temperature Sensor Diode	

bits 3-0 NSEL3: NSEL2: NSEL1: NSEL0: Negative Channel Select

0000 = A <sub>IN0</sub>	0100 = A <sub>IN4</sub>
0001 = A <sub>IN1</sub>	0101 = A <sub>IN5</sub>
0010 = A <sub>IN2</sub>	0110 = A <sub>IN6</sub>
0011 = A <sub>IN3</sub>	0111 = A <sub>IN7</sub>
1xxx = A <sub>INCOM</sub> (except when all bits are 1s)	
1111 = Temperature Sensor Diode	

**ACR** (Address 02<sub>H</sub>) Analog Control Register

Reset value is set by Flash memory page 0. Factory programmed to 00<sub>H</sub>.

bit 7	bit 6	bit 5	bit 4	bit 3	bit 2	bit 1	bit 0
BOCS	IDAC2R1	IDAC2R0	IDAC1R1	IDAC1R0	PGA2	PGA1	PGA0

bit 7 BOCS: Burnout Current Source  
0 = Disabled  
1 = Enabled

$$\text{IDAC Current} = \left( \frac{V_{\text{REF}}}{8R_{\text{DAC}}} \right) (2^{\text{RANGE}-1}) (\text{DAC Code})$$

bits 6-5 IDAC2R1: IDAC2R0: Full-Scale Range Select for IDAC2

00 = Off  
01 = Range 1  
10 = Range 2  
11 = Range 3

bits 4-3 IDAC1R1: IDAC1R0: Full-Scale Range Select for IDAC1

00 = Off  
01 = Range 1  
10 = Range 2  
11 = Range 3

bits 2-0 PGA2: PGA1: PGA0: Programmable Gain Amplifier Gain Selection

000 = 1	100 = 16
001 = 2	101 = 32
010 = 4	110 = 64
011 = 8	111 = 128

**IDAC1** (Address 03<sub>H</sub>) Current DAC 1

Reset value is set by Flash memory page 0. Factory programmed to 00<sub>H</sub>.

bit 7	bit 6	bit 5	bit 4	bit 3	bit 2	bit 1	bit 0
IDAC1_7	IDAC1_6	IDAC1_5	IDAC1_4	IDAC1_3	IDAC1_2	IDAC1_1	IDAC1_0

The DAC code bits set the output of DAC1 from 0 to full-scale. The value of the full-scale current is set by this Byte, V<sub>REF</sub>, R<sub>DAC</sub>, and the DAC1 range bits in the ACR register.

**IDAC2** (Address 04<sub>H</sub>) Current DAC 2

Reset value is set by Flash memory page 0. Factory programmed to 00<sub>H</sub>.

bit 7	bit 6	bit 5	bit 4	bit 3	bit 2	bit 1	bit 0
IDAC2_7	IDAC2_6	IDAC2_5	IDAC2_4	IDAC2_3	IDAC2_2	IDAC2_1	IDAC2_0

The DAC code bits set the output of DAC2 from 0 to full-scale. The value of the full-scale current is set by this Byte, V<sub>REF</sub>, R<sub>DAC</sub>, and the DAC2 range bits in the ACR register.

**ODAC** (Address 05<sub>H</sub>) Offset DAC Setting

Reset value is set by Flash memory page 0. Factory programmed to 00<sub>H</sub>.

bit 7	bit 6	bit 5	bit 4	bit 3	bit 2	bit 1	bit 0
SIGN	OSET6	OSET5	OSET4	OSET3	OSET2	OSET1	OSET0

bit 7      Offset Sign  
 0 = Positive  
 1 = Negative

bits 6-0      
$$\text{Offset} = \frac{V_{REF}}{2PGA} \times \left( \frac{\text{Code}}{127} \right)$$

NOTE:      The offset must be used after calibration or the calibration will notify the effects.

**DIO** (Address 06<sub>H</sub>) Digital I/O

Reset value is set by Flash memory page 0. Factory programmed to 00<sub>H</sub>.

bit 7	bit 6	bit 5	bit 4	bit 3	bit 2	bit 1	bit 0
DIO7	DIO6	DIO5	DIO4	DIO3	DIO2	DIO1	DIO0

A value written to this register will appear on the digital I/O pins if the pin is configured as an output in the DIR register. Reading this register will return the value of the digital I/O pins.

**DIR** (Address 07<sub>H</sub>) Direction control for digital I/O

Reset value is set by Flash memory page 0. Factory programmed to FF<sub>H</sub>.

bit 7	bit 6	bit 5	bit 4	bit 3	bit 2	bit 1	bit 0
DIR7	DIR6	DIR5	DIR4	DIR3	DIR2	DIR1	DIR0

Each bit controls whether the Digital I/O pin is an output (= 0) or input (= 1). The default power-up state is as inputs.



**DEC0** (Address 08<sub>H</sub>) Decimation Register (least significant 8 bits)

Reset value is set by Flash memory page 0. Factory programmed to 80<sub>H</sub>.

bit 7	bit 6	bit 5	bit 4	bit 3	bit 2	bit 1	bit 0
DEC07	DEC06	DEC05	DEC04	DEC03	DEC02	DEC01	DEC00

The decimation value is defined with 11 bits for a range of 20 to 2047. This register is the least significant 8 bits. The 3 most significant bits are contained in the M/DEC1 register.

**M/DEC1** (Address 09<sub>H</sub>) Mode and Decimation Register

Reset value is set by Flash memory page 0. Factory programmed to 07<sub>H</sub>.

bit 7	bit 6	bit 5	bit 4	bit 3	bit 2	bit 1	bit 0
$\overline{DRDY}$	U/ $\overline{B}$	SMODE1	SMODE0	WREN	DEC10	DEC09	DEC08

bit 7  $\overline{DRDY}$ : Data Ready (Read Only)  
This bit duplicates the state of the  $\overline{DRDY}$  pin.

bit 6 U/ $\overline{B}$ : Data Format  
0 = Bipolar  
1 = Unipolar

U/ $\overline{B}$	ANALOG INPUT	DIGITAL OUTPUT
0	+FS Zero -FS	0x7FFFFF 0x000000 0x800000
1	+FS Zero -FS	0xFFFFFFFF 0x000000 0x000000

bits 5-4 SMODE1: SMODE0: Settling Mode  
00 = Auto  
01 = Fast Settling filter  
10 = Sinc2 filter  
11 = Sinc3 filter

bit 3 WREN: Flash Write Enable  
0 = Flash Writing Disabled  
1 = Flash Writing Enabled  
This bit and the WREN pin must both be enabled in order to write to the Flash memory.

bits 2-0 DEC10: DEC09: DEC08: Most Significant Bits of the Decimation Value

**OCR0** (Address 0A<sub>H</sub>) Offset Calibration Coefficient (least significant byte)

Reset value is set by Flash memory page 0. Factory programmed to 00<sub>H</sub>.

bit 7	bit 6	bit 5	bit 4	bit 3	bit 2	bit 1	bit 0
OCR07	OCR06	OCR05	OCR04	OCR03	OCR02	OCR01	OCR00

**OCR1** (Address 0B<sub>H</sub>) Offset Calibration Coefficient (middle byte)

Reset value is set by Flash memory page 0. Factory programmed to 00<sub>H</sub>.

bit 7	bit 6	bit 5	bit 4	bit 3	bit 2	bit 1	bit 0
OCR15	OCR14	OCR13	OCR12	OCR11	OCR10	OCR09	OCR08

**OCR2** (Address 0C<sub>H</sub>) Offset Calibration Coefficient (most significant byte)

Reset value is set by Flash memory page 0. Factory programmed to 00<sub>H</sub>.

bit 7	bit 6	bit 5	bit 4	bit 3	bit 2	bit 1	bit 0
OCR23	OCR22	OCR21	OCR20	OCR19	OCR18	OCR17	OCR16

**FSR0** (Address 0D<sub>H</sub>) Full-Scale Register (least significant byte)

Reset value is set by Flash memory page 0. Factory programmed to 24<sub>H</sub>.

bit 7	bit 6	bit 5	bit 4	bit 3	bit 2	bit 1	bit 0
FSR07	FSR06	FSR05	FSR04	FSR03	FSR02	FSR01	FSR00

**FSR1** (Address 0E<sub>H</sub>) Full-Scale Register (middle byte)

Reset value is set by Flash memory page 0. Factory programmed to 90<sub>H</sub>.

bit 7	bit 6	bit 5	bit 4	bit 3	bit 2	bit 1	bit 0
FSR15	FSR14	FSR13	FSR12	FSR11	FSR10	FSR09	FSR08

**FSR2** (Address 0F<sub>H</sub>) Full-Scale Register (most significant byte)

Reset value is set by Flash memory page 0. Factory programmed to 67<sub>H</sub>.

bit 7	bit 6	bit 5	bit 4	bit 3	bit 2	bit 1	bit 0
FSR23	FSR22	FSR21	FSR20	FSR19	FSR18	FSR17	FSR16

## COMMAND DEFINITIONS

The commands listed below control the operation of the ADS1218. Some of the commands are stand-alone commands (e.g., RESET) while others require additional bytes (e.g., WREG requires command, count, and the data bytes). Commands that output data require a minimum of four  $f_{OSC}$  cycles before the data is ready (e.g., RDATA).

Operands:  $n$  = count (0 to 127)

$r$  = register (0 to 15)

$x$  = don't care

$a$  = RAM bank address (0 to 7)

$f$  = Flash memory page address (0 to 31)

**Table 3. Command Summary**

COMMANDS	DESCRIPTION	COMMAND BYTE <sup>(1)</sup>	2ND COMMAND BYTE
RDATA	Read Data	0000 0001 (01 <sub>H</sub> )	—
RDATA_C	Read Data Continuously	0000 0011 (03 <sub>H</sub> )	—
STOPC	Stop Read Data Continuously	0000 1111 (0F <sub>H</sub> )	—
RREG	Read from REG Bank $rrrr$	0001 $r r r r$ (1x <sub>H</sub> )	xxxx_nnnn (# of reg–1)
RRAM	Read from RAM Bank $aaa$	0010 0aaa (2x <sub>H</sub> )	xnnn_nnnn (# of bytes–1)
CREG	Copy REGs to RAM Bank $aaa$	0100 0aaa (4x <sub>H</sub> )	—
CREGA	Copy REGS to all RAM Banks	0100 1000 (48 <sub>H</sub> )	—
WREG	Write to REG $rrrr$	0101 $r r r r$ (5x <sub>H</sub> )	xxxx_nnnn (# of reg–1)
WRAM	Write to RAM Bank $aaa$	0110 0aaa (6x <sub>H</sub> )	xnnn_nnnn (# of bytes–1)
RF2R	Read Flash page to RAM	100f ffff (8, 9x <sub>H</sub> )	—
WR2F	Write RAM to Flash page	101f ffff (A, Bx <sub>H</sub> )	—
CRAM	Copy RAM Bank $aaa$ to REG	1100 0aaa (Cx <sub>H</sub> )	—
CSRAMX	Calc RAM Bank $aaa$ Checksum	1101 0aaa (Dx <sub>H</sub> )	—
CSARAMX	Calc all RAM Bank Checksum	1101 1000 (D8 <sub>H</sub> )	—
CSREG	Calc REG Checksum	1101 1111 (DF <sub>H</sub> )	—
CSRAM	Calc RAM Bank $aaa$ Checksum	1110 0aaa (Ex <sub>H</sub> )	—
CSARAM	Calc all RAM Banks Checksum	1110 1000 (E8 <sub>H</sub> )	—
CSFL	Calc Flash Checksum	1110 1100 (EC <sub>H</sub> )	—
SELFCAL	Self Cal Offset and Gain	1111 0000 (F0 <sub>H</sub> )	—
SELFOCAL	Self Cal Offset	1111 0001 (F1 <sub>H</sub> )	—
SELFGCAL	Self Cal Gain	1111 0010 (F2 <sub>H</sub> )	—
YSOCAL	Sys Cal Offset	1111 0011 (F3 <sub>H</sub> )	—
YSGCAL	Sys Cal Gain	1111 0100 (F4 <sub>H</sub> )	—
DSYNC	Sync $\overline{DRDY}$	1111 1100 (FC <sub>H</sub> )	—
SLEEP	Put in SLEEP Mode	1111 1101 (FD <sub>H</sub> )	—
RESET	Reset to Power-Up Values	1111 1110 (FE <sub>H</sub> )	—

(1) The data input received by the ADS1218 is always MSB first. The data out format is set by the BIT ORDER bit in ACR reg.

**RDATA**

**Read Data**

**Description:** Read a single 24-bit ADC conversion result. On completion of read back,  $\overline{\text{DRDY}}$  goes high.

**Operands:** None

**Bytes:** 1

**Encoding:** 0000 0001

**Data Transfer Sequence:**

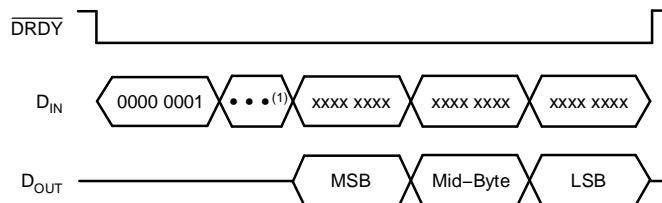

**RDATA C**

**Read Data Continuous**

**Description:** Read Data Continuous mode enables the continuous output of new data on each  $\overline{\text{DRDY}}$ . This command eliminates the need to send the Read Data Command on each  $\overline{\text{DRDY}}$ . This mode may be terminated by either the STOP Read Continuous command or the RESET command.

**Operands:** None

**Bytes:** 1

**Encoding:** 0000 0011

**Data Transfer Sequence:**

Command terminated when  $uuuu\ uuuu$  equals STOPC or RESET.

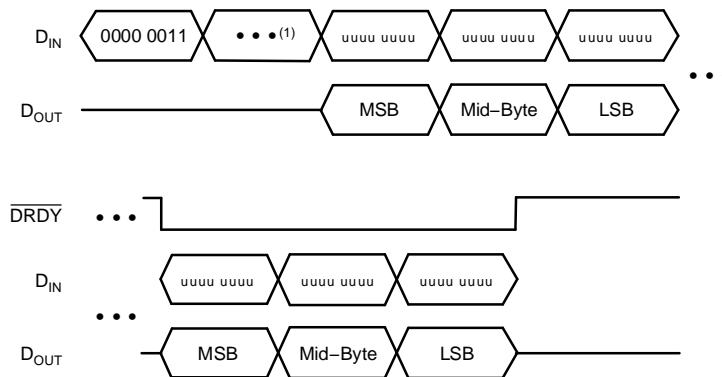

NOTE: (1) For wait time, refer to timing specification.

**STOPC**

**Stop Continuous**

**Description:** Ends the continuous data output mode.

**Operands:** None

**Bytes:** 1

**Encoding:** 0000 1111

**Data Transfer Sequence:**

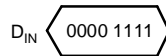

**RREG**

**Read from Registers**

**Description:** Output the data from up to 16 registers starting with the register address specified as part of the instruction. The number of registers read will be one plus the second byte. If the count exceeds the remaining registers, the addresses will wrap back to the beginning.

**Operands:** r, n

**Bytes:** 2

**Encoding:** 0001 rrrr xxxx nnnn

**Data Transfer Sequence:**

Read Two Registers Starting from Register 01<sub>H</sub> (MUX)

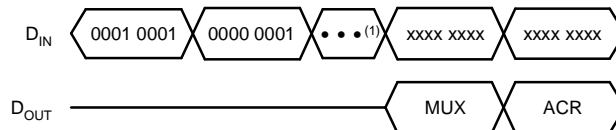

NOTE: (1) For wait time, refer to timing specification.

**RRAM**

**Read from RAM**

**Description:** Up to 128 bytes can be read from RAM starting at the bank specified in the op code. All reads start at the address for the beginning of the RAM bank. The number of bytes to read will be one plus the value of the second byte.

**Operands:** a, n

**Bytes:** 2

**Encoding:** 0010 0aaa xnnn nnnn

**Data Transfer Sequence:**

Read Two RAM Locations Starting from 20<sub>H</sub>

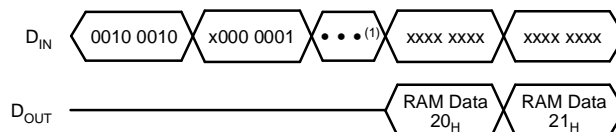

NOTE: (1) For wait time, refer to timing specification.

**CREG**

**Copy Registers to RAM Bank**

**Description:** Copy the 16 control registers to the RAM bank specified in the op code. Refer to timing specifications for command execution time.

**Operands:** a

**Bytes:** 1

**Encoding:** 0100 0aaa

**Data Transfer Sequence:**

Copy Register Values to RAM Bank 3

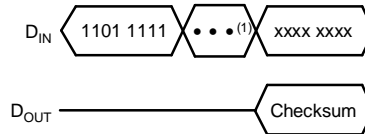

NOTE: (1) For wait time, refer to timing specification.

**CREGA**

**Copy Registers to All RAM Banks**

**Description:** Duplicate the 16 control registers to all the RAM banks. Refer to timing specifications for command execution time.

**Operands:** None

**Bytes:** 1

**Encoding:** 0100 1000

**Data Transfer Sequence:**

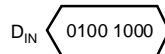

**WREG**

**Write to Register**

**Description:** Write to the registers starting with the register specified as part of the instruction. The number of registers that will be written is one plus the value of the second byte.

**Operands:** r, n

**Bytes:** 2

**Encoding:** 0101 rrrr xxxx nnnn

**Data Transfer Sequence:**

Write Two Registers Starting from 06<sub>H</sub> (DIO)

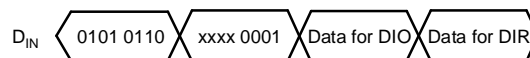

**WRAM**

**Write to RAM**

**Description:** Write up to 128 RAM locations starting at the beginning of the RAM bank specified as part of the instruction. The number of bytes written is RAM is one plus the value of the second byte.

**Operands:** a, n

**Bytes:** 2

**Encoding:** 0110 0aaa xnnn nnnn

**Data Transfer Sequence:**

Write to Two RAM Locations starting from 10<sub>H</sub>

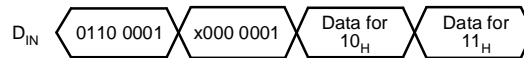

**RF2R**

**Read Flash Memory Page to RAM**

**Description:** Read the selected Flash memory page to the RAM.

**Operands:** f

**Bytes:** 1

**Encoding:** 100f ffff

**Data Transfer Sequence:**

Read Flash Page 2 to RAM

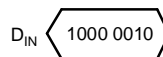

**WR2F**

**Write RAM to Flash Memory**

**Description:** Write the contents of RAM to the selected Flash memory page.

**Operands:** f

**Bytes:** 1

**Encoding:** 101f ffff

**Data Transfer Sequence:**

Write RAM to Flash Memory Page 31

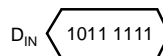

**CRAM**

**Copy RAM Bank to Registers**

**Description:** Copy the selected RAM Bank to the Configuration Registers. This will overwrite all of the registers with the data from the RAM bank.

**Operands:** a

**Bytes:** 1

**Encoding:** 1100 0aaa

**Data Transfer Sequence:**

Copy RAM Bank 0 to the Registers

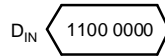

**CSRAMX**

**Calculate RAM Bank Checksum**

**Description:** Calculate the checksum of the selected RAM Bank. The checksum is calculated as a sum of all the bytes with the carry ignored. The ID,  $\overline{DRDY}$ , and DIO bits are masked so they are not included in the checksum.

**Operands:** a

**Bytes:** 1

**Encoding:** 1101 0aaa

**Data Transfer Sequence:**

Calculate Checksum for RAM Bank 3

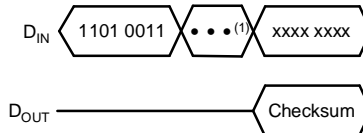

NOTE: (1) For wait time, refer to timing specification.

**CSARAMX**

**Calculate the Checksum for all RAM Banks**

**Description:** Calculate the checksum of all RAM Banks. The checksum is calculated as a sum of all the bytes with the carry ignored. The ID,  $\overline{DRDY}$ , and DIO bits are masked so they are not included in the checksum.

**Operands:** None

**Bytes:** 1

**Encoding:** 1101 1000

**Data Transfer Sequence:**

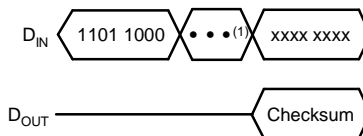

NOTE: (1) For wait time, refer to timing specification.



**CSREG**

**Calculate the Checksum of Registers**

**Description:** Calculate the checksum of all the registers. The checksum is calculated as a sum of all the bytes with the carry ignored. The ID,  $\overline{\text{DRDY}}$ , and DIO bits are masked so they are not included in the checksum.

**Operands:** None

**Bytes:** 1

**Encoding:** 1101 1111

**Data Transfer Sequence:**

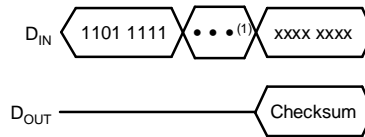

NOTE: (1) For wait time, refer to timing specification.

**CSRAM**

**Calculate RAM Bank Checksum**

**Description:** Calculate the checksum of the selected RAM Bank. The checksum is calculated as a sum of all the bytes with the carry ignored. All bits are included in the checksum calculation; there is no masking of bits.

**Operands:** a

**Bytes:** 1

**Encoding:** 1110 0aaa

**Data Transfer Sequence:**

Calculate Checksum for RAM Bank 2

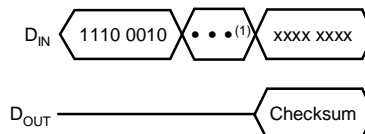

NOTE: (1) For wait time, refer to timing specification.

**CSARAM**

**Calculate Checksum for all RAM Banks**

**Description:** Calculate the checksum of all RAM Banks. The checksum is calculated as a sum of all the bytes with the carry ignored. All bits are included in the checksum calculation; there is no masking of bits.

**Operands:** None

**Bytes:** 1

**Encoding:** 1110 1000

**Data Transfer Sequence:**

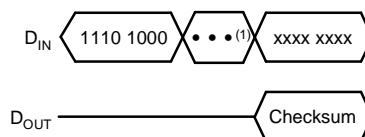

NOTE: (1) For wait time, refer to timing specification.

**CSFL****Calculate Checksum for all Flash Memory Pages**

**Description:** Calculate the checksum for all Flash memory pages. The checksum is calculated as a sum of all the bytes with the carry ignored. All bits are included in the checksum calculation; there is no masking of bits.

**Operands:** None

**Bytes:** 1

**Encoding:** 1110 1100

**Data Transfer Sequence:**

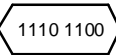
D<sub>IN</sub> 

**SELFCAL****Offset and Gain Self Calibration**

**Description:** Starts the process of self calibration. The Offset Control Register (OCR) and the Full-Scale Register (FSR) are updated with new values after this operation.

**Operands:** None

**Bytes:** 1

**Encoding:** 1111 0000

**Data Transfer Sequence:**

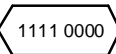
D<sub>IN</sub> 

**SELFOCAL****Offset Self Calibration**

**Description:** Starts the process of self-calibration for offset. The Offset Control Register (OCR) is updated after this operation.

**Operands:** None

**Bytes:** 1

**Encoding:** 1111 0001

**Data Transfer Sequence:**

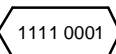
D<sub>IN</sub> 

**SELFGCAL****Gain Self Calibration**

**Description:** Starts the process of self-calibration for gain. The Full-Scale Register (FSR) is updated with new values after this operation.

**Operands:** None

**Bytes:** 1

**Encoding:** 1111 0010

**Data Transfer Sequence:**

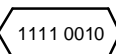
D<sub>IN</sub> 

**YSOCAL**

**System Offset Calibration**

**Description:** Starts the system offset calibration process. For a system offset calibration, the input should be set to 0V differential, and the ADS1218 computes the OCR register value that will compensate for offset errors. The Offset Control Register (OCR) is updated after this operation.

**Operands:** None

**Bytes:** 1

**Encoding:** 1111 0011

**Data Transfer Sequence:**

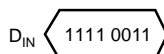

**YSGCAL**

**System Gain Calibration**

**Description:** Starts the system gain calibration process. For a system gain calibration, the differential input should be set to the reference voltage and the ADS1218 computes the FSR register value that will compensate for gain errors. The FSR is updated after this operation.

**Operands:** None

**Bytes:** 1

**Encoding:** 1111 0100

**Data Transfer Sequence:**

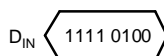

**DSYNC**

**Sync  $\overline{DRDY}$**

**Description:** Synchronizes the ADS1218 to the serial clock edge.

**Operands:** None

**Bytes:** 1

**Encoding:** 1111 1100

**Data Transfer Sequence:**

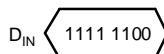

**SLEEP**

**Sleep Mode**

**Description:** Puts the ADS1218 into a low-power sleep mode. SCLK must be inactive while in sleep mode. To exit this mode, issue the WAKEUP command.

**Operands:** None

**Bytes:** 1

**Encoding:** 1111 1101

**Data Transfer Sequence:**

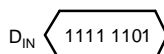

**WAKEUP**

**Wakeup From Sleep Mode**

**Description:** Use this command to wake up from sleep mode.

**Operands:** None

**Bytes:** 1

**Encoding:** 1111 1011

**Data Transfer Sequence:**

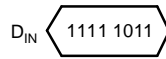

**RESET**

**Reset Registers**

**Description:** Copy the contents of Flash memory page 0 to the registers. This command will also stop the Read Continuous mode.

**Operands:** None

**Bytes:** 1

**Encoding:** 1111 1110

**Data Transfer Sequence:**

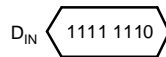

**Table 4. ADS1218 Command Map**

MSB	LSB															
	0000	0001	0010	0011	0100	0101	0110	0111	1000	1001	1010	1011	1100	1101	1110	1111
0000	x <sup>(1)</sup>	rdata	x	rdatac	x	x	x	x	x	x	x	x	x	x	x	stopc
0001	rreg 0	rreg 1	rreg 2	rreg 3	rreg 4	rreg 5	rreg 6	rreg 7	rreg 8	rreg 9	rreg A	rreg B	rreg C	rreg D	rreg E	rreg F
0010	rram 0	rram 1	rram 2	rram 3	rram 4	rram 5	rram 6	rram 7	x	x	x	x	x	x	x	x
0011	x	x	x	x	x	x	x	x	x	x	x	x	x	x	x	x
0100	creg 0	creg 1	creg 2	creg 3	creg 4	creg 5	creg 6	creg 7	crega	x	x	x	x	x	x	x
0101	wreg 0	wreg 1	wreg 2	wreg 3	wreg 4	wreg 5	wreg 6	wreg 7	wreg 8	wreg 9	wreg A	wreg B	wreg C	wreg D	wreg E	wreg F
0110	wram 0	wram 1	wram 2	wram 3	wram 4	wram 5	wram 6	wram 7	x	x	x	x	x	x	x	x
0111	x	x	x	x	x	x	x	x	x	x	x	x	x	x	x	x
1000	rf2r 0	rf2r 1	rf2r 2	rf2r 3	rf2r 4	rf2r 5	rf2r 6	rf2r 7	rf2r 8	rf2r 9	rf2r A	rf2r B	rf2r C	rf2r D	rf2r E	rf2r F
1001	rf2r 10	rf2r 11	rf2r 12	rf2r 13	rf2r 14	rf2r 15	rf2r 16	rf2r 17	rf2r 18	rf2r 19	rf2r 1A	rf2r 1B	rf2r 1C	rf2r 1D	rf2r 1E	rf2r 1F
1010	wr2f 0	wr2f 1	wr2f 2	wr2f 3	wr2f 4	wr2f 5	wr2f 6	wr2f 7	wr2f 8	wr2f 9	wr2f A	wr2f B	wr2f C	wr2f D	wr2f E	wr2f F
1011	wr2f 10	wr2f 11	wr2f 12	wr2f 13	wr2f 14	wr2f 15	wr2f 16	wr2f 17	wr2f 18	wr2f 19	wr2f 1A	wr2f 1B	wr2f 1C	wr2f 1D	wr2f 1E	wr2f 1F
1100	cram 0	cram 1	cram 2	cram 3	cram 4	cram 5	cram 6	cram 7	x	x	x	x	x	x	x	x
1101	csramx 0	csramx 1	csramx 2	csramx 3	csramx 4	csramx 5	csramx 6	csramx 7	csramx	x	x	x	x	x	x	csreg
1110	csram 0	csram 1	csram 2	csram 3	csram 4	csram 5	csram 6	csram 7	csramx	x	x	x	csfl	x	x	x
1111	self cal	self ocal	self gcal	sys ocal	sys gcal	x	x	x	x	x	x	x	dsync	sleep	reset	x

(1) x = Reserved

## DEFINITION OF RULES

**Analog Input Voltage**—the voltage at any one analog input relative to AGND.

**Analog Input Differential Voltage**—given by the following equation:  $(A_{IN+}) - (A_{IN-})$ . Thus, a positive digital output is produced whenever the analog input differential voltage is positive, while a negative digital output is produced whenever the differential is negative.

For example, when the converter is configured with a 2.5V reference and placed in a gain setting of 1, the positive full-scale output is produced when the analog input differential is 2.5V. The negative full-scale output is produced when the differential is -2.5V. In each case, the actual input voltages must remain within the AGND to  $AV_{DD}$  range.

**Conversion Cycle**—the term *conversion cycle* usually refers to a discrete A/D conversion operation, such as that performed by a successive approximation converter. As used here, a conversion cycle refers to the  $t_{DATA}$  time period. However, each digital output is actually based on the modulator results from several  $t_{DATA}$  time periods.

FILTER SETTING	MODULATOR RESULTS
Fast Settling	1 $t_{DATA}$ Time Period
Sinc <sup>2</sup>	2 $t_{DATA}$ Time Period
Sinc <sup>3</sup>	3 $t_{DATA}$ Time Period

**Data Rate**—the rate at which conversions are completed. See definition for  $f_{DATA}$ .

**Decimation Ratio**—defines the ratio between the output of the modulator and the output Data Rate. Valid values for the Decimation Ratio are from 20 to 2047. Larger Decimation Ratios will have lower noise.

**Effective Resolution**—the effective resolution of the ADS1218 in a particular configuration can be expressed in two different units: bits rms (referenced to output) and Vrms (referenced to input). Computed directly from the converter's output data, each is a statistical calculation. The conversion from one to the other is shown below.

*Effective number of bits (ENOB) or effective resolution* is commonly used to define the usable resolution of the A/D converter. It is calculated from empirical data taken directly from the device. It is typically determined by applying a fixed known signal source to the analog input and computing the standard deviation of the data sample set. The rms noise defines the  $\pm\sigma$  interval about the sample mean.

The data from the A/D converter is output as codes, which then can be easily converted to other units, such as ppm or volts. The equations and table below show the relationship between bits or codes, ppm, and volts.

$$ENOB = \frac{-20 \log(\text{ppm})}{6.02}$$

BITS rms	BIPOLAR Vrms	UNIPOLAR Vrms
	$\frac{(2 \times V_{REF})}{PGA}$ $10^{\left(\frac{6.02 \times ER}{20}\right)}$	$\frac{(V_{REF})}{PGA}$ $10^{\left(\frac{6.02 \times ER}{20}\right)}$
24	298nV	149nV
22	1.19 $\mu$ V	597nV
20	4.77 $\mu$ V	2.39 $\mu$ V
18	19.1 $\mu$ V	9.55 $\mu$ V
16	76.4 $\mu$ V	38.2 $\mu$ V
14	505 $\mu$ V	152.7 $\mu$ V
12	1.22mV	610 $\mu$ V

**$f_{DATA}$** —the frequency of the digital output data produced by the ADS1218.  $f_{DATA}$  is also referred to as the Data Rate.

$$f_{DATA} = \left( \frac{f_{MOD}}{\text{Decimation Ratio}} \right) = \left( \frac{f_{OSC}}{\text{mfactor} \times \text{Decimation Ratio}} \right)$$

**$f_{MOD}$** —the frequency or speed at which the modulator of the ADS1218 is running. This depends on the SPEED bit as shown below:

SPEED BIT	$f_{MOD}$
0	$f_{OSC}/128$
1	$f_{OSC}/256$

**$f_{OSC}$** —the frequency of the crystal input signal at the  $X_{IN}$  input of the ADS1218.

**$f_{SAMP}$** —the frequency, or switching speed, of the input sampling capacitor. The value is given by one of the following equations:

PGA SETTING	SAMPLING FREQUENCY
1, 2, 4, 8	$f_{SAMP} = \frac{f_{OSC}}{\text{mfactor}}$
8	$f_{SAMP} = \frac{2f_{OSC}}{\text{mfactor}}$
16	$f_{SAMP} = \frac{8f_{OSC}}{\text{mfactor}}$
32	$f_{SAMP} = \frac{16f_{OSC}}{\text{mfactor}}$
64, 128	$f_{SAMP} = \frac{16f_{OSC}}{\text{mfactor}}$

**Filter Selection**—the ADS1218 uses a (sinc/x) filter or sinc filter. There are three different sinc filters that can be selected. A fast settling filter will settle in one  $t_{DATA}$  cycle. The sinc<sup>2</sup> filter will settle in two cycles and have lower noise. The sinc<sup>3</sup> will achieve lowest noise and higher number of effective bits, but requires three cycles to settle. The ADS1218 will operate with any one of these filters, or it can operate in an auto mode, where it will first select the fast settling filter after a new channel is selected for two readings and will then switch to sinc<sup>2</sup> for one reading, followed by sinc<sup>3</sup> from then on.

**Full-Scale Range (FSR)**—as with most A/D converters, the full-scale range of the ADS1218 is defined as the *input*, which produces the positive full-scale digital output minus the *input*, which produces the negative full-scale digital output. The full-scale range changes with gain setting; see [Table 5](#).

For example, when the converter is configured with a 2.5V reference and is placed in a gain setting of 2, the full-scale range is: [1.25V (positive full-scale) – (–1.25V (negative full-scale))] = 2.5V.

**Least Significant Bit (LSB) Weight**—this is the theoretical amount of voltage that the differential voltage at the analog input would have to change in order to observe a change in the output data of one least significant bit. It is computed as follows:

$$\text{LSB Weight} = \frac{\text{Full-Scale Range}}{2^N}$$

where N is the number of bits in the digital output.

$t_{DATA}$ —the inverse of  $f_{DATA}$ , or the period between each data output.

**Table 5. Full-Scale Range versus PGA Setting**

GAIN SETTING	5V SUPPLY ANALOG INPUT <sup>(1)</sup>			GENERAL EQUATIONS		
	FULL-SCALE RANGE	DIFFERENTIAL INPUT VOLTAGES <sup>(2)</sup>	PGA OFFSET RANGE	FULL-SCALE RANGE	DIFFERENTIAL INPUT VOLTAGES <sup>(2)</sup>	PGA SHIFT RANGE
1	5V	±2.5V	±1.25V	$\frac{2V_{REF}}{PGA}$	$\pm \frac{V_{REF}}{PGA}$	$\pm \frac{V_{REF}}{2PGA}$
2	2.5V	±1.25V	±0.625V			
4	1.25V	±0.625V	±312.5mV			
8	0.625V	±312.5mV	±156.25mV			
16	312.5mV	±156.25mV	±78.125mV			
34	156.25mV	±78.125mV	±39.0625mV			
64	78.125mV	±39.0625mV	±19.531mV			
128	39.0625mV	±19.531mV	±9.766mV			

(1) With a 2.5V reference.

(2) The ADS1218 allows common-mode voltage as long as the absolute input voltage on  $A_{IN+}$  or  $A_{IN-}$  does not go below AGND or above  $AV_{DD}$ .

**PACKAGING INFORMATION**

Orderable Device	Status <sup>(1)</sup>	Package Type	Package Drawing	Pins	Package Qty	Eco Plan <sup>(2)</sup>	Lead/ Ball Finish	MSL Peak Temp <sup>(3)</sup>	Samples (Requires Login)
ADS1218Y/250	ACTIVE	TQFP	PFB	48	250	Green (RoHS & no Sb/Br)	CU NIPDAU	Level-2-260C-1 YEAR	
ADS1218Y/250G4	ACTIVE	TQFP	PFB	48	250	Green (RoHS & no Sb/Br)	CU NIPDAU	Level-2-260C-1 YEAR	

<sup>(1)</sup> The marketing status values are defined as follows:

**ACTIVE:** Product device recommended for new designs.

**LIFEBUY:** TI has announced that the device will be discontinued, and a lifetime-buy period is in effect.

**NRND:** Not recommended for new designs. Device is in production to support existing customers, but TI does not recommend using this part in a new design.

**PREVIEW:** Device has been announced but is not in production. Samples may or may not be available.

**OBSOLETE:** TI has discontinued the production of the device.

<sup>(2)</sup> Eco Plan - The planned eco-friendly classification: Pb-Free (RoHS), Pb-Free (RoHS Exempt), or Green (RoHS & no Sb/Br) - please check <http://www.ti.com/productcontent> for the latest availability information and additional product content details.

**TBD:** The Pb-Free/Green conversion plan has not been defined.

**Pb-Free (RoHS):** TI's terms "Lead-Free" or "Pb-Free" mean semiconductor products that are compatible with the current RoHS requirements for all 6 substances, including the requirement that lead not exceed 0.1% by weight in homogeneous materials. Where designed to be soldered at high temperatures, TI Pb-Free products are suitable for use in specified lead-free processes.

**Pb-Free (RoHS Exempt):** This component has a RoHS exemption for either 1) lead-based flip-chip solder bumps used between the die and package, or 2) lead-based die adhesive used between the die and leadframe. The component is otherwise considered Pb-Free (RoHS compatible) as defined above.

**Green (RoHS & no Sb/Br):** TI defines "Green" to mean Pb-Free (RoHS compatible), and free of Bromine (Br) and Antimony (Sb) based flame retardants (Br or Sb do not exceed 0.1% by weight in homogeneous material)

<sup>(3)</sup> MSL, Peak Temp. -- The Moisture Sensitivity Level rating according to the JEDEC industry standard classifications, and peak solder temperature.

**Important Information and Disclaimer:** The information provided on this page represents TI's knowledge and belief as of the date that it is provided. TI bases its knowledge and belief on information provided by third parties, and makes no representation or warranty as to the accuracy of such information. Efforts are underway to better integrate information from third parties. TI has taken and continues to take reasonable steps to provide representative and accurate information but may not have conducted destructive testing or chemical analysis on incoming materials and chemicals. TI and TI suppliers consider certain information to be proprietary, and thus CAS numbers and other limited information may not be available for release.

In no event shall TI's liability arising out of such information exceed the total purchase price of the TI part(s) at issue in this document sold by TI to Customer on an annual basis.

**TAPE AND REEL INFORMATION**

**REEL DIMENSIONS**



**TAPE DIMENSIONS**



A0	Dimension designed to accommodate the component width
B0	Dimension designed to accommodate the component length
K0	Dimension designed to accommodate the component thickness
W	Overall width of the carrier tape
P1	Pitch between successive cavity centers

**TAPE AND REEL INFORMATION**

\*All dimensions are nominal

Device	Package Type	Package Drawing	Pins	SPQ	Reel Diameter (mm)	Reel Width W1 (mm)	A0 (mm)	B0 (mm)	K0 (mm)	P1 (mm)	W (mm)	Pin1 Quadrant
ADS1218Y/250	TQFP	PFB	48	250	177.8	16.4	9.6	9.6	1.5	12.0	16.0	Q2



**TAPE AND REEL BOX DIMENSIONS**

\*All dimensions are nominal

Device	Package Type	Package Drawing	Pins	SPQ	Length (mm)	Width (mm)	Height (mm)
ADS1218Y/250	TQFP	PFB	48	250	210.0	185.0	35.0

PFB (S-PQFP-G48)

PLASTIC QUAD FLATPACK



- NOTES: A. All linear dimensions are in millimeters.  
 B. This drawing is subject to change without notice.  
 C. Falls within JEDEC MS-026

PFB (S-PQFP-G48)



- NOTES:
- A. All linear dimensions are in millimeters.
  - B. This drawing is subject to change without notice.
  - C. Publication IPC-7351 is recommended for alternate designs.
  - D. Laser cutting apertures with trapezoidal walls and also rounding corners will offer better paste release. Customers should contact their board assembly site for stencil design recommendations. Refer to IPC-7525.
  - E. Customers should contact their board fabrication site for solder mask tolerances between and around signal pads.

## IMPORTANT NOTICE

Texas Instruments Incorporated and its subsidiaries (TI) reserve the right to make corrections, modifications, enhancements, improvements, and other changes to its products and services at any time and to discontinue any product or service without notice. Customers should obtain the latest relevant information before placing orders and should verify that such information is current and complete. All products are sold subject to TI's terms and conditions of sale supplied at the time of order acknowledgment.

TI warrants performance of its hardware products to the specifications applicable at the time of sale in accordance with TI's standard warranty. Testing and other quality control techniques are used to the extent TI deems necessary to support this warranty. Except where mandated by government requirements, testing of all parameters of each product is not necessarily performed.

TI assumes no liability for applications assistance or customer product design. Customers are responsible for their products and applications using TI components. To minimize the risks associated with customer products and applications, customers should provide adequate design and operating safeguards.

TI does not warrant or represent that any license, either express or implied, is granted under any TI patent right, copyright, mask work right, or other TI intellectual property right relating to any combination, machine, or process in which TI products or services are used. Information published by TI regarding third-party products or services does not constitute a license from TI to use such products or services or a warranty or endorsement thereof. Use of such information may require a license from a third party under the patents or other intellectual property of the third party, or a license from TI under the patents or other intellectual property of TI.

Reproduction of TI information in TI data books or data sheets is permissible only if reproduction is without alteration and is accompanied by all associated warranties, conditions, limitations, and notices. Reproduction of this information with alteration is an unfair and deceptive business practice. TI is not responsible or liable for such altered documentation. Information of third parties may be subject to additional restrictions.

Resale of TI products or services with statements different from or beyond the parameters stated by TI for that product or service voids all express and any implied warranties for the associated TI product or service and is an unfair and deceptive business practice. TI is not responsible or liable for any such statements.

TI products are not authorized for use in safety-critical applications (such as life support) where a failure of the TI product would reasonably be expected to cause severe personal injury or death, unless officers of the parties have executed an agreement specifically governing such use. Buyers represent that they have all necessary expertise in the safety and regulatory ramifications of their applications, and acknowledge and agree that they are solely responsible for all legal, regulatory and safety-related requirements concerning their products and any use of TI products in such safety-critical applications, notwithstanding any applications-related information or support that may be provided by TI. Further, Buyers must fully indemnify TI and its representatives against any damages arising out of the use of TI products in such safety-critical applications.

TI products are neither designed nor intended for use in military/aerospace applications or environments unless the TI products are specifically designated by TI as military-grade or "enhanced plastic." Only products designated by TI as military-grade meet military specifications. Buyers acknowledge and agree that any such use of TI products which TI has not designated as military-grade is solely at the Buyer's risk, and that they are solely responsible for compliance with all legal and regulatory requirements in connection with such use.

TI products are neither designed nor intended for use in automotive applications or environments unless the specific TI products are designated by TI as compliant with ISO/TS 16949 requirements. Buyers acknowledge and agree that, if they use any non-designated products in automotive applications, TI will not be responsible for any failure to meet such requirements.

Following are URLs where you can obtain information on other Texas Instruments products and application solutions:

### Products

Audio	<a href="http://www.ti.com/audio">www.ti.com/audio</a>
Amplifiers	<a href="http://amplifier.ti.com">amplifier.ti.com</a>
Data Converters	<a href="http://dataconverter.ti.com">dataconverter.ti.com</a>
DLP® Products	<a href="http://www.dlp.com">www.dlp.com</a>
DSP	<a href="http://dsp.ti.com">dsp.ti.com</a>
Clocks and Timers	<a href="http://www.ti.com/clocks">www.ti.com/clocks</a>
Interface	<a href="http://interface.ti.com">interface.ti.com</a>
Logic	<a href="http://logic.ti.com">logic.ti.com</a>
Power Mgmt	<a href="http://power.ti.com">power.ti.com</a>
Microcontrollers	<a href="http://microcontroller.ti.com">microcontroller.ti.com</a>
RFID	<a href="http://www.ti-rfid.com">www.ti-rfid.com</a>
OMAP Mobile Processors	<a href="http://www.ti.com/omap">www.ti.com/omap</a>
Wireless Connectivity	<a href="http://www.ti.com/wirelessconnectivity">www.ti.com/wirelessconnectivity</a>

### Applications

Communications and Telecom	<a href="http://www.ti.com/communications">www.ti.com/communications</a>
Computers and Peripherals	<a href="http://www.ti.com/computers">www.ti.com/computers</a>
Consumer Electronics	<a href="http://www.ti.com/consumer-apps">www.ti.com/consumer-apps</a>
Energy and Lighting	<a href="http://www.ti.com/energy">www.ti.com/energy</a>
Industrial	<a href="http://www.ti.com/industrial">www.ti.com/industrial</a>
Medical	<a href="http://www.ti.com/medical">www.ti.com/medical</a>
Security	<a href="http://www.ti.com/security">www.ti.com/security</a>
Space, Avionics and Defense	<a href="http://www.ti.com/space-avionics-defense">www.ti.com/space-avionics-defense</a>
Transportation and Automotive	<a href="http://www.ti.com/automotive">www.ti.com/automotive</a>
Video and Imaging	<a href="http://www.ti.com/video">www.ti.com/video</a>

TI E2E Community Home Page

[e2e.ti.com](http://e2e.ti.com)

Mailing Address: Texas Instruments, Post Office Box 655303, Dallas, Texas 75265  
Copyright © 2011, Texas Instruments Incorporated