



16-Bit, 125 MSPS 2x/4x/8x Interpolating Dual TxDAC+[®] D/A Converter

Preliminary Technical Data

02-14-01

AD9777

FEATURES

- 16 Bit Resolution, 125 MSPS Conversion Rate
- Selectable 2x/4x/8x Interpolating Filter
- Programmable Channel Gain and Offset Adjustment
- Fs/2,4,8 Digital Quadrature Modulation Capability
- Direct IF Transmission Mode for 70MHz+ IFs
- Enables Image Rejection Architecture
- Fully Compatible SPI Port
- Excellent AC Performance
 - SFDR -73dBc @ 2-35MHz
 - WCDMA ACPR -73dB @ IF=16.25 MHz
- Internal PLL Clock Multiplier
- Selectable Internal Clock Divider
- Versatile Clock Input
 - Differential/Single Ended
 - Sine Wave or TTL/CMOS/LVPECL Compatible
- Versatile Input Data Interface
 - 2's Complement/Straight Binary Data Coding
 - Dual Port or Single Port Interleaved Data
- Single +3.3V Supply Operation
- Power Dissipation: typical 700 mW @ 3.3V
- On-chip 1.2 V Reference, 80-Lead LQFP

APPLICATIONS

- Communications:
 - Analog Quadrature Modulation Architectures
 - 3G, Multi-Carrier GSM, TDMA, CDMA Systems
 - Multi-Level QAM Modulators, Instrumentation

PRODUCT DESCRIPTION

The AD9777 is the 16 bit member of the AD977x family of pin-compatible, high performance, programmable 2x/4x/8x interpolating TxDAC+s. The AD977x family features a serial port interface (SPI) providing a high level of programmability thus allowing for enhanced system level options. These options include: selectable 2x/4x/8x interpolation filters; Fs/2, Fs/4 or Fs/8 digital quadrature modulation with image rejection; a direct IF mode; programmable channel gain and offset control; programmable internal clock divider; straight binary or two's complement data interface; and a single port or dual port data interface.

PROGRAMMABLE DUAL INTERPOLATION DAC WITH IMAGE REJECTION/DIGITAL MODULATION

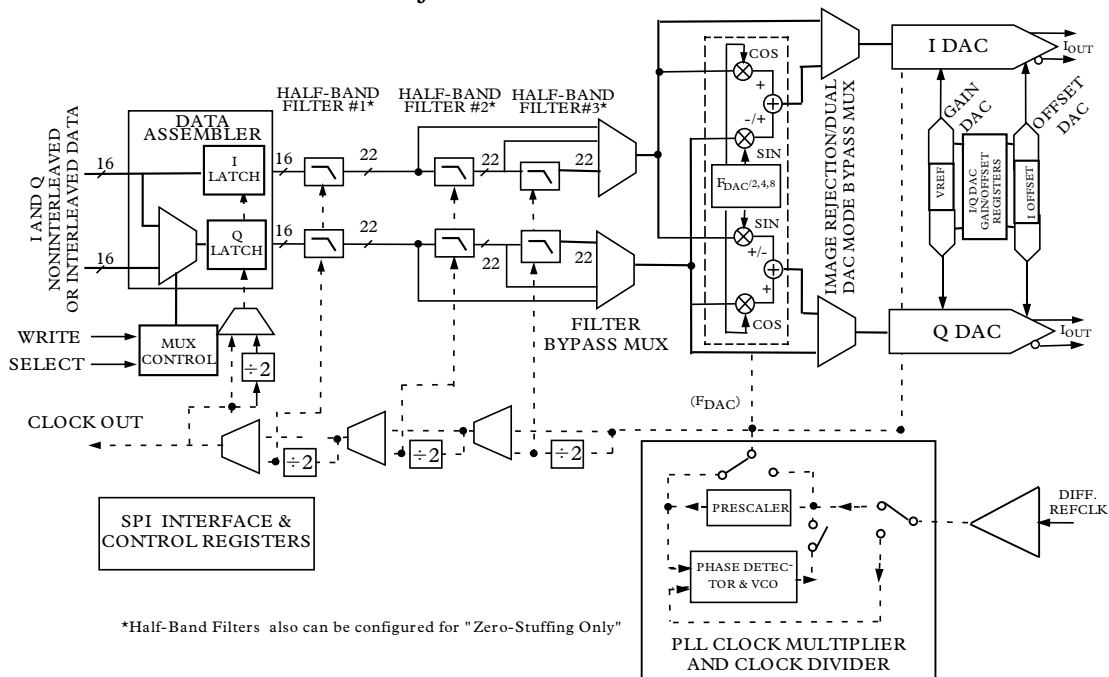

*Half-Band Filters also can be configured for "Zero-Stuffing Only"

REV. PrA

BLOCK DIAGRAM

Information furnished by Analog Devices is believed to be accurate and reliable. However, no responsibility is assumed by Analog Devices for its use, nor for any infringements of patents or other rights of third parties which may result from its use. No license is granted by implication or otherwise under any patent or patent rights of Analog Devices.

One Technology Way, P.O. Box 9106, Norwood, MA 02062-9106, U.S.A.
 Tel: 781/329-4700 World Wide Web Site: <http://www.analog.com>
 Fax: 781/326-8703 © Analog Devices, Inc., 2000

AD9777

PRODUCT DESCRIPTION (Continued)

The selectable $2\times/4\times/8\times$ interpolation filters simplify the requirements of the reconstruction filters while simultaneously enhancing the TxDAC+ family's passband noise/distortion performance. The independent channel gain and offset registers allow the user to calibrate LO feedthrough and sideband suppression errors associated with analog quadrature modulators. The 6 dB of gain adjustment range also can be used to control the output power level of each DAC.

The AD9777 features the ability to perform $F_s/4$ and $F_s/8$ digital modulation and image rejection when combined with an analog quadrature modulator. In this mode, the AD9777 would accept I and Q complex data (representing a single or multicarrier waveform), generate a quadrature modulated IF signal along with its orthogonal representation via its dual DACs, and present these two reconstructed orthogonal IF carriers to an analog quadrature modulator to complete the image rejection upconversion process. Another digital modulation mode (i.e. the Direct IF Mode) allows the original baseband signal representation to be frequency translated such that pairs of images fall at multiples of $1/2$ the DAC update rate.

The AD9777 family includes a flexible clock interface accepting differential or single-ended sinewave or digital logic inputs. An internal PLL clock multiplier is also included to generate the necessary on-chip high frequency clocks. It can also be disabled to allow the use of a higher performance external clock source. An internal programmable divider simplifies clock generation in the converter when using an external clock source. A flexible data input interface allows for straight binary or 2's complement formats as well as supports single port interleaved or dual port data.

Dual high performance TxDAC+s provides a differential current output programmable over a 2-20mA range. The AD9777 is manufactured on an advanced 0.35 micron CMOS process, operates from a single supply of 3.0V to 3.6 V and consumes 700 mW of power.

Targeted at wide dynamic range, Multi-Carrier and Multi-Standard systems, the superb baseband performance of the AD9777 is ideal for Wideband-CDMA, Multi-Carrier CDMA, Multi-Carrier TDMA, Multi-Carrier GSM and high performance systems employing high order QAM modulation schemes. The image rejection feature simplifies and can help to reduce the number of signal band filters needed in an transmit signal chain. The direct IF mode helps to eliminate a costly mixer stage for a variety of communications systems.

PRODUCT HIGHLIGHTS

1. The AD9777 is the 16 bit member of the AD977x family of pin-compatible, high performance, programmable $2\times/4\times/8\times$ interpolating TxDAC+s.
2. Direct IF Transmission capability for 70MHz +IFs through a novel digital mixing process
3. $F_s/8$ Digital Quadrature Modulation and user selectable image rejection to simplify /remove cascaded SAW filter stages
4. $2\times/4\times/8\times$ User Selectable Interpolating Filter eases data rate and output signal reconstruction filter requirements.
5. User selectable 2's Complement/Straight Binary Data Coding.
6. User programmable Channel Gain Control over 1 dB range in 0.01dB increments
7. User programmable Channel Offset +/-10% over the FSR
8. Ultra high speed 400 MSPS DAC conversion rate.
9. Internal Clock Divider provides data rate clock for easy interfacing.
10. Flexible Clock Input with Single Ended or Differential Input, CMOS or 1V p-p LO Sinewave input capability.
11. Low Power: Complete CMOS DAC operates on 700 mW from a 3.0V to 3.6V single supply. The 20ma full-scale current can be reduced for lower power operation, and a several sleep functions are provided to reduce power during idle periods.
12. On-chip Voltage Reference: The AD9777 includes a 1.20 V temperature-compensated bandgap voltage reference.
13. 80 lead LQFP

AD9777—SPECIFICATIONS

DC SPECIFICATIONS (T_{MIN} to T_{MAX} , AVDD = +3.3 V, CLKVDD = +3.3 V, DVDD = +3.3 V, PLLVDD = +3.3V, I_{OUTFS} = 20 mA, unless otherwise noted)

PARAMETER	MIN	TYP	MAX	UNITS
RESOLUTION	16			bits
DC Accuracy ¹				
Integral Non-Linearity				LSB
Differential Non_Linearity				LSB
Monotonicity				
ANALOG OUTPUT				
Offset Error				% of FSR
Gain Error (Without Internal Reference)				% of FSR
Gain Error (With Internal Reference)				% of FSR
Full-Scale Output Current ²		20		mA
Output Compliance Range	-1.0		+1.25	V
Output Resistance		200		k Ω
Output Capacitance		3		pF
REFERENCE OUTPUT				
Reference Voltage	1.14	1.20	1.26	V
Reference Output Current ³		1		μ A
REFERENCE INPUT				
Input Compliance Range	0.1		1.25	V
Reference Input Resistance (REFLO = 3 V)			10	M Ω
Small Signal Bandwidth		0.5		MHz
TEMPERATURE COEFFICIENTS				
Unipolar Offset Drift				ppm of FSR/ $^{\circ}$ C
Gain Drift (Without Internal Reference)				ppm of FSR/ $^{\circ}$ C
Gain Drift (With Internal Reference)				ppm of FSR/ $^{\circ}$ C
Reference Voltage Drift				ppm/ $^{\circ}$ C
POWER SUPPLY				
AVDD				
Voltage Range	3.0	3.3	3.6	V
Analog Supply Current (I_{AVDD})				mA
I_{AVDD} in SLEEP Mode				mA
CLKVDD				
Voltage Range	3.0	3.3	3.6	V
Clock Supply Current (I_{CLKVDD})				mA
PLLVDD				
Voltage Range	3.0	3.3	3.6	V
PLL Multiplier Supply Current (I_{PLLVDD})				mA
DVDD				
Voltage Range	3.0	3.3	3.6	V
Digital Supply Current (I_{DVDD})				mA
Nominal Power Dissipation		700		mW
Power Supply Rejection Ratio – AVDD				% of FSR/V
Power Supply Rejection Ratio – DVDD				% of FSR/V
OPERATING RANGE	-40		+85	$^{\circ}$ C

NOTES

¹Measured at I_{OUTA} driving a virtual ground.

²Nominal full-scale current, I_{OUTFS} , is $32 \times$ the I_{REF} current.

³Use an external amplifier to drive any external load.

Specifications subject to change without notice.

AD9777—SPECIFICATIONS

DYNAMIC SPECIFICATIONS (T_{MIN} to T_{MAX}, AVDD = +3.3 V, CLKVDD = +3.3 V, DVDD = +3.3 V, PLLVDD = 0 V, I_{OUTFS} = 20 mA, Differential Transformer Coupled Output, 50Ω Doubly Terminated, unless otherwise noted)

Parameter	Min	Typ	Max	Units
DYNAMIC PERFORMANCE				
Maximum DAC Output Update Rate (f _{DAC})	400			MSPS
Output Settling Time (t _{ST}) (to 0.025%)				ns
Output Propagation Delay ¹ (t _{PD})				ns
Output Rise Time (10% to 90%) ²				ns
Output Fall Time (10% to 90%) ²				ns
Output Noise (I _{OUTFS} = 20 mA)				pA√Hz
ACLINERITY—BASEBAND MODE				
Spurious-Free Dynamic Range (SFDR) to Nyquist (f _{OUT} = 0 dBFS)				
f _{DATA} = MSPS; f _{OUT} = MHz				dBc
f _{DATA} = MSPS; f _{OUT} = MHz				dBc
f _{DATA} = MSPS; f _{OUT} = MHz				dBc
f _{DATA} = MSPS; f _{OUT} = MHz				dBc
f _{DATA} = MSPS; f _{OUT} = MHz				dBc
f _{DATA} = MSPS; f _{OUT} = MHz				dBc
Two-Tone Intermodulation (IMD) to Nyquist (f _{OUT1} = f _{OUT2} = -6 dBFS)				
f _{DATA} = MSPS; f _{OUT1} = MHz; f _{OUT2} = MHz				dBc
f _{DATA} = MSPS; f _{OUT1} = MHz; f _{OUT2} = MHz				dBc
f _{DATA} = MSPS; f _{OUT1} = MHz; f _{OUT2} = MHz				dBc
f _{DATA} = MSPS; f _{OUT1} = MHz; f _{OUT2} = MHz				dBc
f _{DATA} = MSPS; f _{OUT1} = MHz; f _{OUT2} = MHz				dBc
f _{DATA} = MSPS; f _{OUT1} = MHz; f _{OUT2} = MHz				dBc
Total Harmonic Distortion (THD)				
f _{DATA} = MSPS; f _{OUT} = MHz; 0 dBFS				dB
f _{DATA} = MSPS; f _{OUT} = MHz; 0 dBFS				dB
Signal-to-Noise Ratio (SNR)				
f _{DATA} = MSPS; f _{OUT} = MHz; 0 dBFS				dB
f _{DATA} = MSPS; f _{OUT} = MHz; 0 dBFS				dB
Adjacent Channel Power Ratio (ACPR)				
WCDMA with MHz BW, MHz Channel Spacing				
IF = 16 MHz, f _{DATA} = 65.536 MSPS				dBc
IF = 32 MHz, f _{DATA} = 131.072 MSPS				dBc
Four-Tone Intermodulation				
MHz, MHz, MHz and MHz at -12 dBFS				dBFS
(f _{DATA} = MSPS, Missing Center)				
ACLINERITY—IF MODE				
Four-Tone Intermodulation at IF = MHz				
MHz, MHz, MHz and MHz at dBFS				dBFS
f _{DATA} = MSPS, f _{DAC} = MHz				

NOTES

¹Propagation delay is delay from CLK input to DAC update.²Measured single-ended into 50 Ω load.

Specifications subject to change without notice.

AD9777—SPECIFICATIONS

DIGITAL SPECIFICATIONS

(T_{MIN} to T_{MAX}, AVDD = +3.3 V, CLKVDD = +3.3 V, PLLVDD = +0 V, DVDD = +3.3 V, I_{OUTFS} = 20 mA, unless otherwise noted)

Parameter	Min	Typ	Max	Units
DIGITAL INPUTS				
Logic "1" Voltage	2.1	3		V
Logic "0" Voltage		0	0.9	V
Logic "1" Current ¹	-10		+10	μA
Logic "0" Current	-10		+10	μA
Input Capacitance		5		pF
CLOCK INPUTS				
Input Voltage Range	0		3	V
Common-Mode Voltage	0.75	1.5	2.25	V
Differential Voltage	0.5	1.5		V
PLL CLOCK ENABLED				
Input Setup Time (t _S)	0.2			ns
Input Hold Time (t _H)	1.8			ns
Latch Pulsewidth (t _{LPW})	1.5			ns
PLL CLOCK DISABLED				
Input Setup Time (t _S)	-1.2			ns
Input Hold Time (t _H)	3.2			ns
Latch Pulsewidth (t _{LPW})	1.5			ns
CLK/PLL LOCK Delay (t _{OD})		TBD		ns

Specifications subject to change without notice.

ORDERING GUIDE

Model	Temperature Range	Package Description	Package Option*
AD9777AST	-40°C to +85°C	80-Lead LQFP	ST-80
AD9777EB		Evaluation Board	

*ST = Thin Plastic Quad Flatpack.

AD9777—SPECIFICATIONS

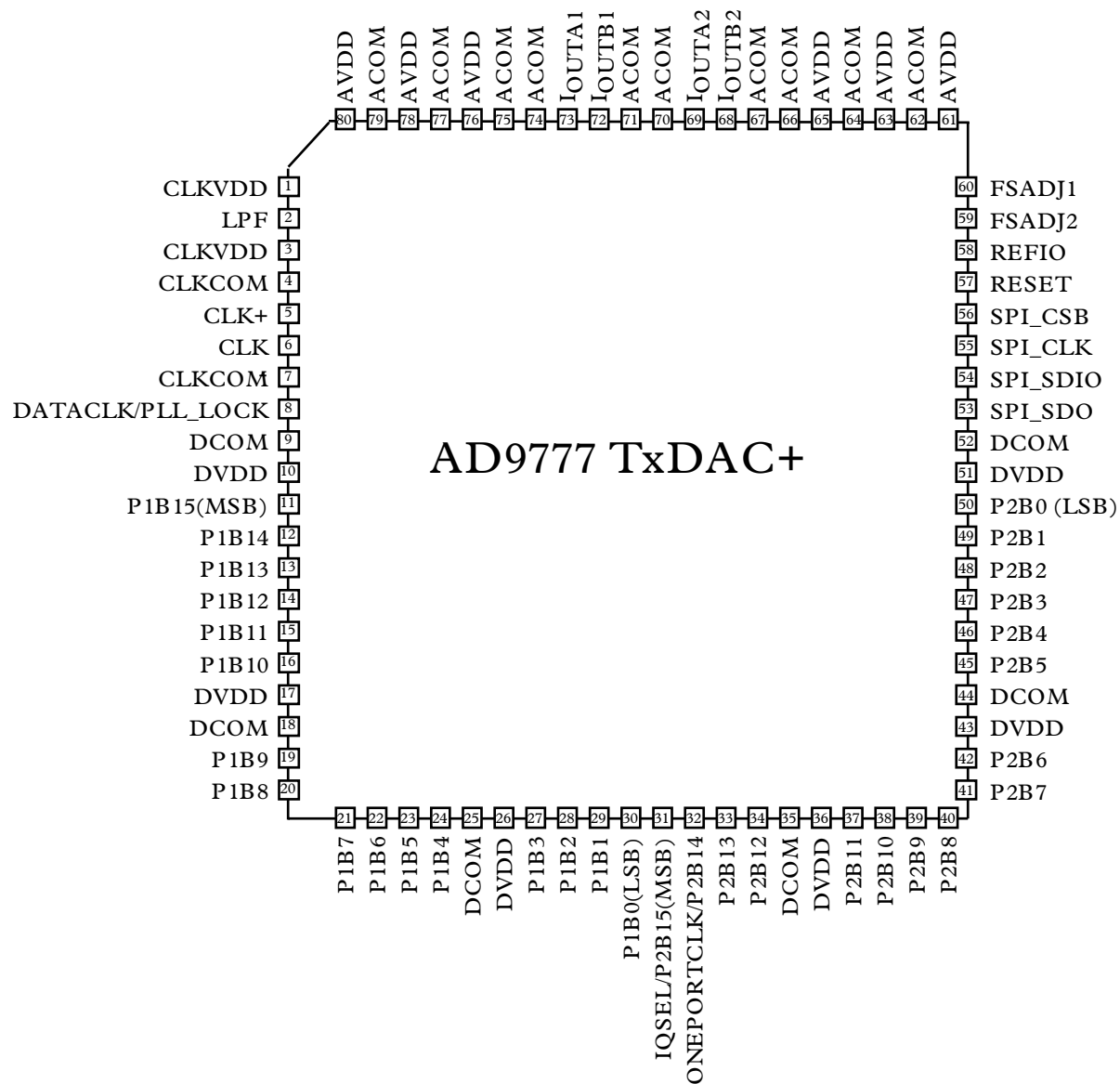

AD9777—SPECIFICATIONS

PIN FUNCTION DESCRIPTIONS

Pin No.	Name	Description
73,72	I_{OUTA1} , I_{OUTB1}	Differential DAC current outputs, I Channel
69,68	I_{OUTA2} , I_{OUTB2}	Differential DAC current outputs, Q Channel
58	REFIO	Reference output, 1.2V nominal
60	FSADJ1	Full-scale current adjust, I channel
59	FSADJ2	Full-scale current adjust, Q channel
5	CLK+	Differential Clock input
6	CLK-	Differential Clock input
8	DATACLK/PLL_LOCK	With the PLL enabled, this pin indicates the state of the PLL. A read of a logic 1 indicates the PLL is in the locked state. Logic 0 indicates the PLL has not achieved lock. With the PLL disabled, and the AD9777 in two port mode, this pin becomes a clock signal, running at the input data rate, which may either be input to the AD9777, or generated by the AD9777, depending on the state of address 2h, bit 3 in the SPI control register.
2	LPF	PLL Loop Filter
57	RESET	Logic one resets all of the SPI port registers, including address 0h, to their default values. A software reset can also be done by writing a logic one to SPI register 0h, bit 5. However, the software reset has no effect on the bits in address 0h.
11-16,19-24,27-30	P1B15 to P1B0	Port 1 data inputs
31	IQSEL/P2B15	In one port mode, IQSEL = 1 followed by a rising edge of the differential input clock will latch the data into the I channel input register. IQSEL = 0 will latch the data into the Q channel input register. In two port mode, this pin becomes the port 2 MSB.
32	ONEPORTCLK/P2B14	With the PLL disabled, and the AD9777 in one port mode, this pin becomes a clock output which runs at twice the input data rate of the I and Q channels. This allows the AD9777 to accept and demux interleaved I and Q data to the I and Q input registers.
33,34,37-42,45-50	P2B13 to P2B0	Port 2 data inputs.
56	SPI_CS	Chip select/SPI data synchronization. On momentary logic high, resets SPI port logic and initializes instruction cycle.
55	SPI_CLK	Data input to the SPI port is registered on the rising edge of SPI_CLK. Data output on the SPI port is registered on the falling edge.
54	SPI_SDIO	Bidirectional data pin. Data direction is controlled by bit 7 of register address 0h. The default setting for this bit is 0, which sets SDIO as an input.
53	SPI_SDO	In the case where SDIO is an input, SDO acts as an output. When SDIO becomes an output, SDO enters a high Z state.
79,77,75,74,71,70, 67,66,64,62	ACOM	Analog Common
80,78,76,65,63,61	AVDD	Analog Supply Voltage
51,43,36,26,17,10	DVDD	Digital Supply Voltage
52,44,35,25,18,9	DCOM	Digital Common
1,3	CLKVDD	Clock Supply Voltage
4,7	CLKCOM	Clock Supply Common

AD9777—SPECIFICATIONS

DIGITAL FILTER SPECIFICATIONS

Halfband Filter #1 (43 coefficients)

tap	coefficient
1,43	8
2,42	0
3,41	-29
4,40	0
5,39	67
6,38	0
7,37	-134
8,36	0
9,35	244
10,34	0
11,33	-414
12,32	0
13,31	673
14,30	0
15,29	-1079
16,28	0
17,27	1772
18,26	0
19,25	-3280
20,24	0
21,23	10364
22	16384

Halfband Filter #2 (19 coefficients)

tap	coefficient
1,19	19
2,18	0
3,17	-120
4,16	0
5,15	438
6,14	0
7,13	-1288
8,12	0
9,11	5047
10	8192

Halfband Filter #3 (11 coefficients)

tap	coefficient
1,11	7
2,10	0
3,9	-53
4,8	0
5,7	302
6	512

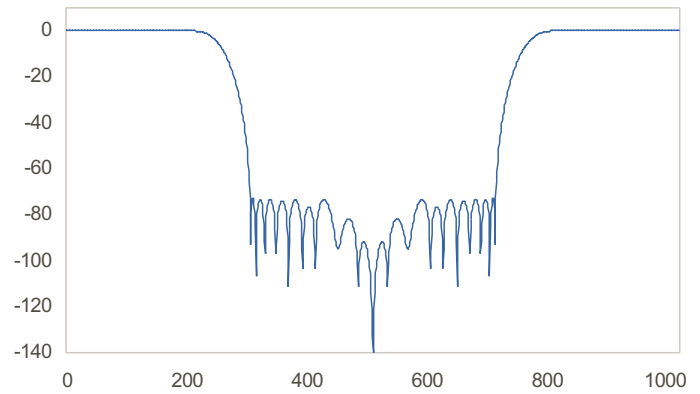

Figure 1a. 2x Interpolating Filter Response

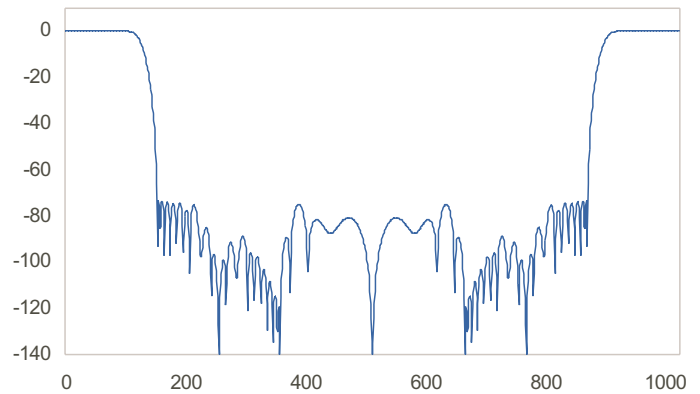

Figure 1b. 4x Interpolating Filter Response

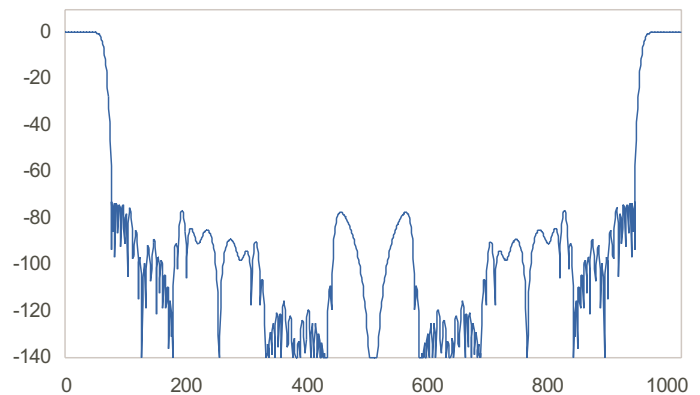

Figure 1c. 8x Interpolating Filter Response

DEFINITIONS OF SPECIFICATIONS**Linearity Error (Also Called Integral Nonlinearity or INL)**

Linearity error is defined as the maximum deviation of the actual analog output from the ideal output, determined by a straight line drawn from zero to full scale.

Differential Nonlinearity (or DNL)

DNL is the measure of the variation in analog value, normalized to full scale, associated with a 1 LSB change in digital input code.

Monotonicity

A D/A converter is monotonic if the output either increases or remains constant as the digital input increases.

Offset Error

The deviation of the output current from the ideal of zero is called offset error. For I_{OUTA} , 0 mA output is expected when the inputs are all 0s. For I_{OUTB} , 0 mA output is expected when all inputs are set to 1s.

Gain Error

The difference between the actual and ideal output span. The actual span is determined by the output when all inputs are set to 1s, minus the output when all inputs are set to 0s.

Output Compliance Range

The range of allowable voltage at the output of a current-output DAC. Operation beyond the maximum compliance limits may cause either output stage saturation or breakdown, resulting in nonlinear performance.

Temperature Drift

Temperature drift is specified as the maximum change from the ambient (+25°C) value to the value at either T_{MIN} or T_{MAX} . For offset and gain drift, the drift is reported in ppm of full-scale range (FSR) per degree C. For reference drift, the drift is reported in ppm per degree C.

Power Supply Rejection

The maximum change in the full-scale output as the supplies are varied from minimum to maximum specified voltages.

Settling Time

The time required for the output to reach and remain within a specified error band about its final value, measured from the start of the output transition.

Glitch Impulse

Asymmetrical switching times in a DAC give rise to undesired output transients that are quantified by a glitch impulse. It is specified as the net area of the glitch in pV-s.

Spurious-Free Dynamic Range

The difference, in dB, between the rms amplitude of the output signal and the peak spurious signal over the specified bandwidth.

Total Harmonic Distortion

THD is the ratio of the rms sum of the first six harmonic components to the rms value of the measured

fundamental. It is expressed as a percentage or in decibels (dB).

Signal-to-Noise Ratio (SNR)

S/N is the ratio of the rms value of the measured output signal to the rms sum of all other spectral components below the Nyquist frequency, excluding the first six harmonics and dc. The value for SNR is expressed in decibels.

Interpolation Filter

If the digital inputs to the DAC are sampled at a multiple rate of f_{DATA} (interpolation rate), a digital filter can be constructed which has a sharp transition band near $f_{DATA}/2$. Images which would typically appear around f_{DAC} (output data rate) can be greatly suppressed.

Passband

Frequency band in which any input applied therein passes unattenuated to the DAC output.

Stopband Rejection

The amount of attenuation of a frequency outside the passband applied to the DAC, relative to a full-scale signal applied at the DAC input within the passband.

Group Delay

Number of input clocks between an impulse applied at the device input and peak DAC output current. A half-band FIR filter has constant group delay over its entire frequency range.

Impulse Response

Response of the device to an impulse applied to the input.

Adjacent Channel Power Ratio (or ACPR)

A ratio in dBc between the measured power within a channel relative to its adjacent channel.

Complex Modulation

The process of passing the real and imaginary components of a signal through a complex modulator (transfer function = $e^{j\omega t} = \cos\omega t + j\sin\omega t$) and realizing real and imaginary components on the modulator output.

Complex Image Rejection

In a traditional two part upconversion, two images are created around the second IF frequency. These images are redundant and have the effect of wasting transmitter power and system bandwidth. By placing the real part of a second complex modulator in series with the first complex modulator, either the upper or lower frequency image near the second IF can be rejected.

AD9777

Mode Control (via SPI Port)

Address	Bit 7	Bit 6	Bit 5	Bit 4	Bit 3	Bit 2	Bit 1	Bit 0
00	SDIO Bidirectional 0 = Input , 1 = I/O	LSB, MSB first 0 = MSB , 1 = LSB	Software reset on logic 1	Sleep Mode. Logic 1 shuts down the DAC output currents.	Powerdown Mode. Logic 1 shuts down all digital and analog functions.	1R/2R Mode. DAC output current set by one or two external resistors. 0 = 2R , 1 = 1R	PLL_LOCK indicator	
01	Filter Interpolation Rate (1x, 2x, 4x, 8x)	Filter Interpolation Rate (1x, 2x, 4x, 8x)	Modulation Mode (none, fs/2, fs/4, fs/8)	Modulation Mode (none, fs/2, fs/4, fs/8)	0 = No Zero Stuffing on Interpolation Filters Logic 1 enables zero stuffing	1 = Real Mix Mode , 0 = Complex Mix Mode	0 = $e^{-j\omega}$ 1 = $e^{+j\omega}$	
02	0 = signed input data , 1 = unsigned	0 = two port mode , 1 = one port mode	DATACLK driver strength		0 = Internally Generated Data Clock , 1 = Externally Applied			
03							PLL divide (prescaler) ratio	PLL divide (prescaler) ratio
04	0 = PLL off , 1 = PLL on	0 = automatic charge pump control , 1 = programmable				PLL charge pump control	PLL charge pump control	PLL charge pump control
05	IDAC fine gain adjustment	IDAC fine gain adjustment	IDAC fine gain adjustment	IDAC fine gain adjustment	IDAC fine gain adjustment	IDAC fine gain adjustment	IDAC fine gain adjustment	IDAC fine gain adjustment
06					IDAC coarse gain adjustment	IDAC coarse gain adjustment	IDAC coarse gain adjustment	IDAC coarse gain adjustment
07	IDAC offset adjustment bit 9	IDAC offset adjustment bit 8	IDAC offset adjustment bit 7	IDAC offset adjustment bit 6	IDAC offset adjustment bit 5	IDAC offset adjustment bit 4	IDAC offset adjustment bit 3	IDAC offset adjustment bit 2
08	IDAC I_{OFFSET} direction. 0 = I_{OFFSET} on IOUTN , 1 = I_{OFFSET} on IOUTP						IDAC offset adjustment bit 1	IDAC offset adjustment bit 0
09	QDAC fine gain adjustment	QDAC fine gain adjustment	QDAC fine gain adjustment	QDAC fine gain adjustment	QDAC fine gain adjustment	QDAC fine gain adjustment	QDAC fine gain adjustment	QDAC fine gain adjustment
0A					QDAC coarse gain adjustment	QDAC coarse gain adjustment	QDAC coarse gain adjustment	QDAC coarse gain adjustment
0B	QDAC offset adjustment bit 9	QDAC offset adjustment bit 8	QDAC offset adjustment bit 7	QDAC offset adjustment bit 6	QDAC offset adjustment bit 5	QDAC offset adjustment bit 4	QDAC offset adjustment bit 3	QDAC offset adjustment bit 2
0C	QDAC I_{OFFSET} direction. 0 = I_{OFFSET} on IOUTN , 1 = I_{OFFSET} on IOUTP						QDAC offset adjustment bit 1	QDAC offset adjustment bit 0
0D					version register	version register	version register	version register

Table 1. Mode Control via SPI Port for AD9777 (default values are highlighted)

Register Description

Address 00h	Bit 7	Logic 0 (default), causes the SDIO pin to act as an input during the data transfer (phase 2) of the communications cycle. When set to a 1, SDIO can act as an input or output, depending on bit 7 of the instruction byte.								
	Bit 6	Logic 0 (default). Determines the direction (LSB/MSB first) of the communications and data transfer communications cycles. Refer to the section MSB/LSB Transfers on page 9 for a detailed description.								
	Bit 5	Writing a one to this bit resets the registers to their default values and restarts the chip. The RESET bit always reads back 0. Register address 0h bits are not cleared by this software reset. However, a high level at the RESET pin forces all registers, including those in address 0h, to their default state.								
	Bit 4	A logic 1 to this bit shuts down the DAC output currents.								
	Bit 3	Powerdown. Logic 1 shuts down all analog and digital functions.								
	Bit 2	1R/2R Mode. The default (0) places the AD9777 in 2 resistor mode. In this mode, the I_{REF} currents for the I and the Q DAC references are set separately by FSADJ1 and FSADJ2 on pins 60 and 59. In this case, $I_{REF1} = 32 \cdot V_{REF} / FSADJ1$ and $I_{REF2} = 32 \cdot V_{REF} / FSADJ2$. With this bit set to 1, the reference currents for both I and Q DACs are controlled by a single resistor on pin 60. I_{REF} in one resistor mode for both the I and Q DACs = $16 \cdot V_{REF} / FSADJ1$								
	Bit 1	PLL_LOCK indicator. When the PLL is enabled, reading this bit will give the status of the PLL. A logic 1 indicates the PLL is locked. A logic 0 indicates an unlocked state.								
Address 01h	Bit 7,6	Filter interpolation rate according to the following table: <table border="0" style="margin-left: 20px;"> <tr><td>00</td><td>1×</td></tr> <tr><td>01</td><td>2×</td></tr> <tr><td>10</td><td>4×</td></tr> <tr><td>11</td><td>8×</td></tr> </table>	00	1×	01	2×	10	4×	11	8×
	00	1×								
01	2×									
10	4×									
11	8×									
Bit 5,4	Modulation mode according to the following table: <table border="0" style="margin-left: 20px;"> <tr><td>00</td><td>none</td></tr> <tr><td>01</td><td>fs/2</td></tr> <tr><td>10</td><td>fs/4</td></tr> <tr><td>11</td><td>fs/8</td></tr> </table>	00	none	01	fs/2	10	fs/4	11	fs/8	
00	none									
01	fs/2									
10	fs/4									
11	fs/8									
Address 01h	Bit 3	Logic 1 enables zero stuffing mode for interpolation filters								
	Bit 2	Default(1) enables the real mix mode. The I and Q data channels are individually modulated by Fs/2, Fs/4 or Fs/8 after the interpolation filters. However, no complex modulation is done. In the complex mix mode (logic 0), the digital modulators on the I and Q data channels are coupled to create a digital complex modulator. When the AD9777 is applied in conjunction with an external quadrature modulator, rejection can be achieved of either the higher or lower frequency image around the 2nd IF frequency (i.e., the 2nd IF frequency is the LO of the analog quadrature modulator external to the AD9777) according to the bit value of register 01h, bit 1.								
	Bit 1	Logic 0 (default) causes the complex modulation to be of the form $e^{-j\omega t}$, resulting in the rejection of the higher frequency image when the AD9777 is used with an external quadrature modulator. A logic 1 causes the modulation to be of the form $e^{+j\omega t}$, which causes rejection of the lower frequency image								
Address 02h	Bit 7	Logic 0 (default) causes data to be accepted on the inputs as 2's complement binary. Logic 1 causes data to be accepted as straight binary.								
	Bit 6	Logic 0 (default) places the AD9777 in two port mode. I and Q data enters the AD9777 via ports one and two, respectively. A logic 1 places the AD9777 in one port mode in which interleaved I and Q data is applied to port one. See pin function descriptions for DATACLK/PLL_LOCK, IQSEL and ONEPORTCLK for detailed information on how to use these modes.								
	Bit 5	DATACLK driver strength. With the internal PLL disabled, and this bit set to logic 0, it is recommended that DATACLK be buffered. When this bit is set to logic 1, DATACLK acts as a stronger driver capable of driving small capacitive loads.								
	Bit 3	External dataclock. With the PLL disabled, pin 8 (DATACLK/PLL_LOCK) becomes a data clock which must run at the same rate as the input data. If this bit is set to a 0 (default), pin 8 is an output and the AD9777 creates this clock. If this bit is a logic 1, pin 8 is an input and an external data clock must be applied and synchronized with the higher rate clock driving CLK+ and CLK-.								

AD9777

Address 03h Bit 1,0 Setting this divide ratio to a higher number allows the VCO in the PLL to run at a high rate (for best performance) while the DAC input and output clocks run substantially slower. The divider ratio is set according to the following table:

00	÷1
01	÷2
10	÷4
11	÷8

Address 04h Bit 7 Logic 0 (default) disables the internal PLL. Logic 1 enables the PLL.
 Bit 6 Logic 0 (default) sets the charge pump control to automatic. In this mode, the charge pump bias current is controlled by the divider ratio defined in address 3h, bits 1 and 0. Logic 1 allows the user to manually define the charge pump bias current using address 4h, bits 2, 1 and 0. Adjusting the charge pump bias current allows the user to optimize the noise/settling performance of the PLL.

Bit 2,1,0 With the charge pump control set to manual, these bits define the charge pump bias current according to the following table:

000	50µamps
001	100
010	200
011	400
100	800

Address 05h,09h Bits 7-0 These bits represent an 8 bit binary number (bit 7, MSB) which defines the fine gain adjustment of the I (5h) and Q (9h) DAC according to the equation given below.

Address 06h,0Ah Bits 3-0 These bits represent a 4 bit binary number (bit 3, MSB) which defines the coarse gain adjustment of the I (6h) and Q (Ah) DACs according to the equation below.

Address 07h,0Bh Bits 7-0

Address 08h,0Ch Bit 1,0 The ten bits from these two address pairs (7h,8h and Bh,Ch) represent a 10 bit binary number which defines the offset adjustment of the I and Q DACs according to the equation below (7h,Bh - bit 7 MSB / 8h,Ch - bit 0 LSB)

Address 08h,0Ch Bit 7 This bit determines the direction of the offset of the I (8h) and Q (Ch) DACs. A logic 0 will apply a positive offset current to I_{OUTA} , while a logic 1 will apply a positive offset current to I_{OUTB} . The magnitude of the offset current is defined by the bits in addresses 7h,Bh,8h,Ch according the the formulas given below.

$$I_{OUTA} = \left[\left(\frac{6 \times I_{REF}}{8} \right) \left(\frac{coarse+1}{16} \right) - \left(\frac{3 \times I_{REF}}{32} \right) \left(\frac{fine}{256} \right) \right] \times \left[\left(\frac{1024}{24} \right) \left(\frac{data}{2^{16}} \right) \right]$$

$$I_{OUTB} = \left[\left(\frac{6 \times I_{REF}}{8} \right) \left(\frac{coarse+1}{16} \right) - \left(\frac{3 \times I_{REF}}{32} \right) \left(\frac{fine}{256} \right) \right] \times \left[\left(\frac{1024}{24} \right) \left(\frac{2^{16} - data - 1}{2^{16}} \right) \right]$$

$$I_{OFFSET} = 2 \times I_{REF} \left(\frac{OFFSET}{1024} \right) \quad (1R \text{ Mode})$$

$$I_{OFFSET} = 4 \times I_{REF} \left(\frac{OFFSET}{1024} \right) \quad (2R \text{ Mode})$$

Figure 2. I_{OUTA} and I_{OUTB} as a function of fine gain, coarse gain and offset adjustment.

*Note that I_{REF} is different for the one resistor and two resistor (1R,2R) modes. See the description for 1R/2R mode control on page 11 (address 0h, bit 2) for the value I_{REF} of in either mode.

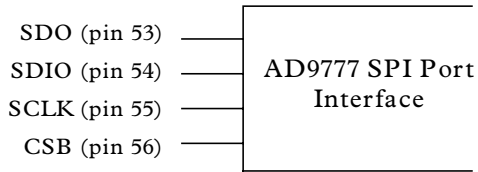

Figure 3. AD9777 SPI Port Interface

Serial Interface For Register Control

The AD9777 serial port is a flexible, synchronous serial communications port allowing easy interface to many industry standard microcontrollers and microprocessors. The serial I/O is compatible with most synchronous transfer formats, including both the Motorola SPI and Intel SSR protocols. The interface allows read/write access to all registers that configure the AD9777. Single or multiple byte transfers are supported as well as MSB first or LSB first transfer formats. The AD9777's serial interface port can be configured as a single pin I/O (SDIO) or two unidirectional pins for in/out (SDIO/SDO).

General Operation of the Serial Interface

There are two phases to a communication cycle with the AD9777. Phase 1 is the instruction cycle, which is the writing of an instruction byte into the AD9777, coincident with the first eight SCLK rising edges. The instruction byte provides the AD9777 serial port controller with information regarding the data transfer cycle, which is Phase 2 of the communication cycle. The Phase 1 instruction byte defines whether the upcoming data transfer is read or write, the number of bytes in the data transfer and the starting register address for the first byte of the data transfer. The first eight SCLK rising edges of each communication cycle are used to write the instruction byte into the AD9777.

A logic high on the CS pin, followed by a logic low, will reset the SPI port timing to the initial state of the instruction cycle. This is true regardless of the present state of the internal registers or the other signal levels present at the inputs to the SPI port. If the SPI port is in the midst of an instruction cycle or a data transfer cycle, none of the present data will be written.

The remaining SCLK edges are for Phase 2 of the communication cycle. Phase 2 is the actual data transfer between the AD9777 and the system controller. Phase 2 of the communication cycle is a transfer of 1, 2, 3, or 4 data bytes as determined by the instruction byte. Normally, using one multibyte transfer is the preferred method. However, single byte data transfers are useful to reduce CPU overhead when register access requires one byte only. Registers change *immediately* upon writing to the last bit of each transfer byte.

Instruction Byte

The instruction byte contains the following information as shown below:

N1	N0	Description
0	0	Transfer 1 Byte
0	1	Transfer 2 Bytes
1	0	Transfer 3 Bytes
1	1	Transfer 4 Bytes

R/W- bit 7 of the instruction byte determines whether a read or a write data transfer will occur after the instruction byte write. Logic high indicates read operation. Logic zero indicates a write operation. N1, N0—Bits 6 and 5 of the instruction byte determine the number of bytes to be transferred during the data transfer cycle. The bit decodes are shown in the following table:

MSB				LSB			
17	16	15	14	13	12	11	10
R/W	N1	N0	A4	A3	A2	A1	A0

A4, A3, A2, A1, A0—Bits 4, 3, 2, 1, 0 of the instruction byte determine which register is accessed during the data transfer portion of the communications cycle. For multibyte transfers, this address is the starting byte address. The remaining register addresses are generated by the AD9777.

Serial Interface Port Pin Description

SCLK (pin55) - Serial Clock. The serial clock pin is used to synchronize data to and from the AD9777 and to run the internal state machines. SCLK maximum frequency is 15 MHz. All data input to the AD9777 is registered on the rising edge of SCLK. All data is driven out of the AD9777 on the falling edge of SCLK.

CSB (pin 56) - Chip Select. Active low input starts and gates a communication cycle. It allows more than one device to be used on the same serial communications lines. The SDO and SDIO pins will go to a high impedance state when this input is high. Chip select should stay low during the entire communication cycle.

SDIO (pin 54) - Serial Data I/O. Data is always written into the AD9777 on this pin. However, this pin can be used as a bidirectional data line. The configuration of this pin is controlled by Bit 7 of register address 00h. The default is logic zero, which configures the SDIO pin as unidirectional.

SDO(pin 53) - Serial Data Out. Data is read from this pin for protocols that use separate lines for transmitting and receiving data. In the case where the AD9777 operates in a single bidirectional I/O mode, this pin does not output data and is set to a high impedance state.

MSB/LSB Transfers

The AD9777 serial port can support both most significant bit (MSB) first or least significant bit (LSB) first data formats. This functionality is controlled by register address 00h bit 6. The default is MSB first. When this bit is set active high, the AD9777 serial port is in LSB first

AD9777

format. That is, if the AD9777 is in LSB first mode, the instruction byte must be written from least significant bit to most significant bit. Multibyte data transfers in MSB format can be completed by writing an instruction byte that includes the register address of the most significant byte. In MSB first mode, the serial port internal byte address generator decrements for each byte required of the multibyte communication cycle. Multibyte data transfers in LSB first format can be completed by writing an instruction byte that includes the register address of the least significant byte. In LSB first mode, the serial port internal byte address generator increments for each byte required of the multibyte communication cycle.

The AD9777 serial port controller address will increment from 1Fh to 00h for multibyte I/O operations if the MSB first mode is active. The serial port controller address will decrement from 00h to 1Fh for multibyte I/O operations if the LSB first mode is active.

Notes on Serial Port Operation

The AD9777 serial port configuration bits reside in bits 6 and 7 of register address 00h. It is important to note that the configuration changes *immediately* upon writing to the last bit of the register. For multibyte transfers, writing to this register may occur during the middle of communication cycle. Care must be taken to compensate for this new configuration for the remaining bytes of the current communication cycle.

The same considerations apply to setting the reset bit in register address 00h. All other registers are set to their default values but the software reset doesn't affect the bits in register address 00h.

It is recommended to use only single byte transfers when changing serial port configurations or initiating a software reset.

A write to bits 1, 2 and 3 of address 00h with the same logic levels as for bits 7, 6 and 5 (bit pattern: XY1001YX binary) allows to reprogram a lost serial port configuration and to reset the registers to their default values. A second write to address 00h with Reset bit low and serial port configuration as specified above (XY) reprograms the OSC IN Multiplier setting. A changed f_{SYSCLK} frequency is stable after a maximum of 200 f_{MCLK} cycles (=Wake-Up Time).

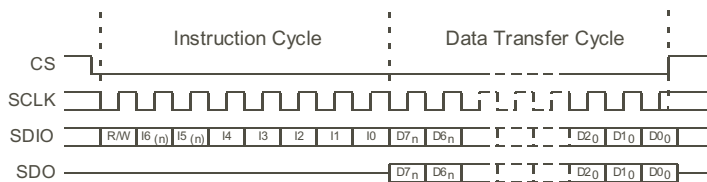

Figure 4a. Serial Register Interface Timing MSB-First

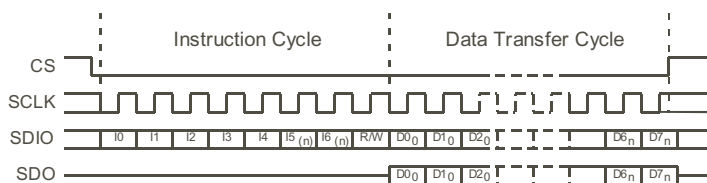

Figure 4b. Serial Register Interface Timing LSB-First

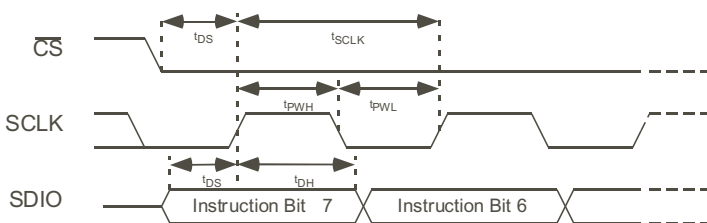

Figure 5. Timing Diagram for Register Write to AD9777

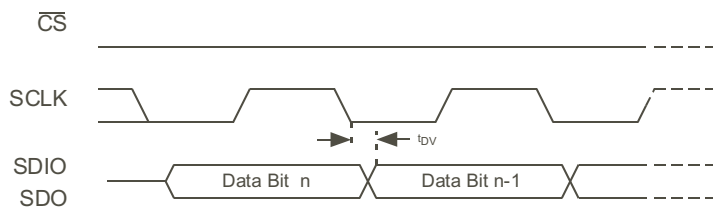

Figure 6. Timing Diagram for Register Read from AD9777

PROGRAMMABLE MODES

The AD9777 has a very flexible structure, programmable via the SPI compliant port with registers defined in table 1. The digital filters can be programmed for 1x, 2x, 4x, or 8x interpolation. Complex modulation can be enabled to allow for image rejection architectures. In addition, fine and coarse adjustments can be made via the SPI port to the DACs to optimize LO suppression and image rejection.

PLL ENABLED

With the Phase Locked Loop (PLL) enabled, a single ended or differential clock, running at the input data rate, must be applied to the CLK+/CLK- inputs. If a single ended clock is to be used, both of these inputs should have the same dc bias. Data at digital input ports one and two is latched into the AD9777 on the rising edge of the input clock. Care should be taken to ensure that the transitions of the input data do not violate the specified set-up and hold times.

The PLL clock multiplier and distribution circuitry produces the necessary internal synchronized 1x, 2x, 4x, and 8x clocks for the rising edge triggered latches, interpolation filters, modulators and DACs. Figure 7 shows a functional block diagram of the AD9777 clock circuitry with the PLL enabled. This circuitry consists of a phase detector, charge pump, voltage controlled oscillator (VCO), prescaler, clock distribution and SPI port control. The charge pump and VCO are powered from PLLVDD while the differential clock input buffer, phase detector, prescaler and clock distribution are powered from CLKVDD. PLL lock status is indicated by the logic signal at the PLL_LOCK pin. To ensure optimum phase noise performance from the PLL clock

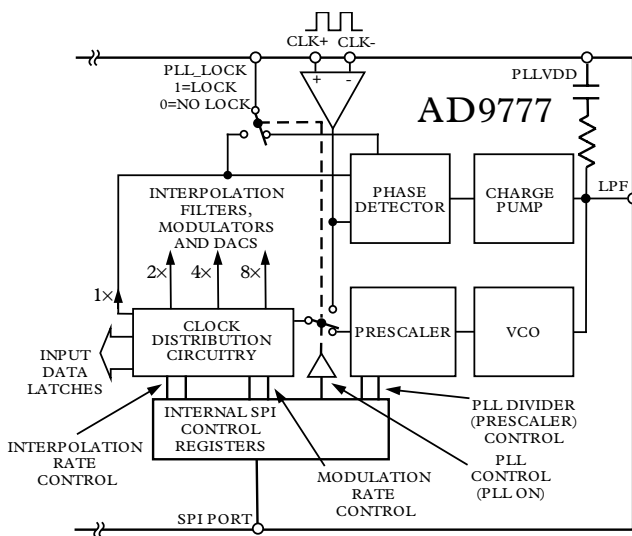

Figure 7. AD9777 PLL and Clock Circuitry with PLL Enabled

multiplier and clock distribution, PLLVDD and CLKVDD must originate from the same clean analog supply. The speed of the VCO with the PLL enabled also has an effect on phase noise. Optimal phase noise with respect to VCO speed is achieved by running the VCO in the range of 500MHz to 550MHz. The VCO speed is a function of the input data rate, of the interpolation rate and of the VCO prescaler according to the following function;

$$\text{VCO Speed (MHz)} = \text{Input Data Rate (MHz)} \times \text{Interpolation Rate} \times \text{Prescaler}$$

It is important to note that the resistor/capacitor needed for the PLL loop filter is included on the AD9777. This will suffice unless the input data rate is below 10MHz, in which case an external series RC will need to be added between the LPF and PLLVDD pins.

PLL DISABLED, TWO PORT MODE

With the PLL disabled, and the AD9777 in two port mode, a single ended or differential clock, running at the DAC output rate, must be applied to the CLK+/CLK- inputs. In this mode, the internal clock dividers on the AD9777 are used to create a clock, available at the DATACLK pin, which runs at the input data rate. This can be used to synchronize the input data. Figure 8 shows a functional block diagram of the AD9777 clock circuitry with the PLL disabled.

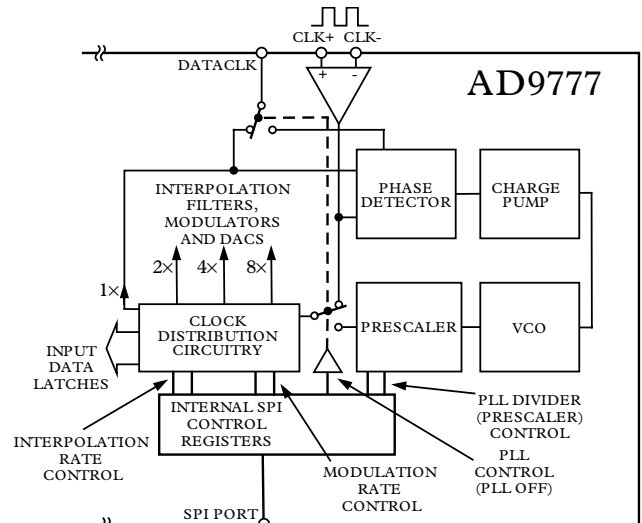

Figure 8. AD9777 PLL and Clock Circuitry with PLL Disabled

The two port mode is selected by setting control register 02h, bit 6, to logic 0. Data is latched into input ports one and two of the AD9777 on the rising edge of the clock at the DATACLK/PLL_LOCK pin (pin 8). This clock can be internally generated by the AD9777 or externally applied by setting control register 02h, bit 3 to the desired value. Whether externally or internally generated, the speed of this clock is defined by the speed of the clock at CLK+/CLK-, divided by the

AD9777

interpolation rate. The input data rate must also match this clock speed. Note that in this mode, the data rate at the inputs to the interpolation filters is the same as the input data rate at ports one and two.

PLL DISABLED, ONE PORT MODE

The one port mode is selected by setting control register 02h, bit 6, to logic 1. Data to the I and Q channels must now be multiplexed onto the data entering data port 1. Pin 32 (ONEPORTCLK) is now a clock signal output. Because the multiplexed data must run at twice the data rate of the inputs to the I and Q channels, the speed of ONEPORTCLK is defined as 2x the speed of the clock at CLK+/CLK-, divided by the interpolation rate. Pin 31 (IQSEL) can be used to select the I or Q channels for input. IQSEL = 1, followed by a rising clock edge will latch the input data into the I channel, while IQSEL = 0, followed by a rising clock edge will latch the input data into the Q channel.

One port mode is very useful when interfacing with devices, such as the Analog Devices AD6622 Transmit Signal Processor, in which two digital data channels have been interlaced (multiplexed).

As defined in control register 02h, bit 7, the AD9777 can accept either signed or unsigned input data.

DIGITAL FILTER MODES

The I and Q data paths of the AD9777 have their own independent half-band FIR filters, providing up to 8x interpolation for each channel. Each channel consists of 3 FIR filters. Figure 1 shows the response of the digital filters when the AD9777 is set to 2x, 4x, and 8x modes. Note that the frequency axis of these graphs have been normalized to the output data rate of the DAC. As the graphs show, the digital filters can provide greater than 75dB of out of band rejection.

MODULATION MODES

INTERPOLATION (NO MODULATION)

With control register 01h, bits five and four, set to 00, the digital modulators on the AD9777 are disabled. The AD9777 operates in this mode simply as a dual interpolating (1x, 2x, 4x, 8x) DAC. The interpolation rate is determined by the setting of bits seven and six in control register address 01h. Figure 9 shows the spectrum in the digital domain of a baseband signal of relatively narrow bandwidth, and how the sinc/x roll-off inherent in the DAC spectrum is affected by the rate of the interpolation filters. More detailed reference on the spectral shape of the interpolation filters is given in Figure 1.

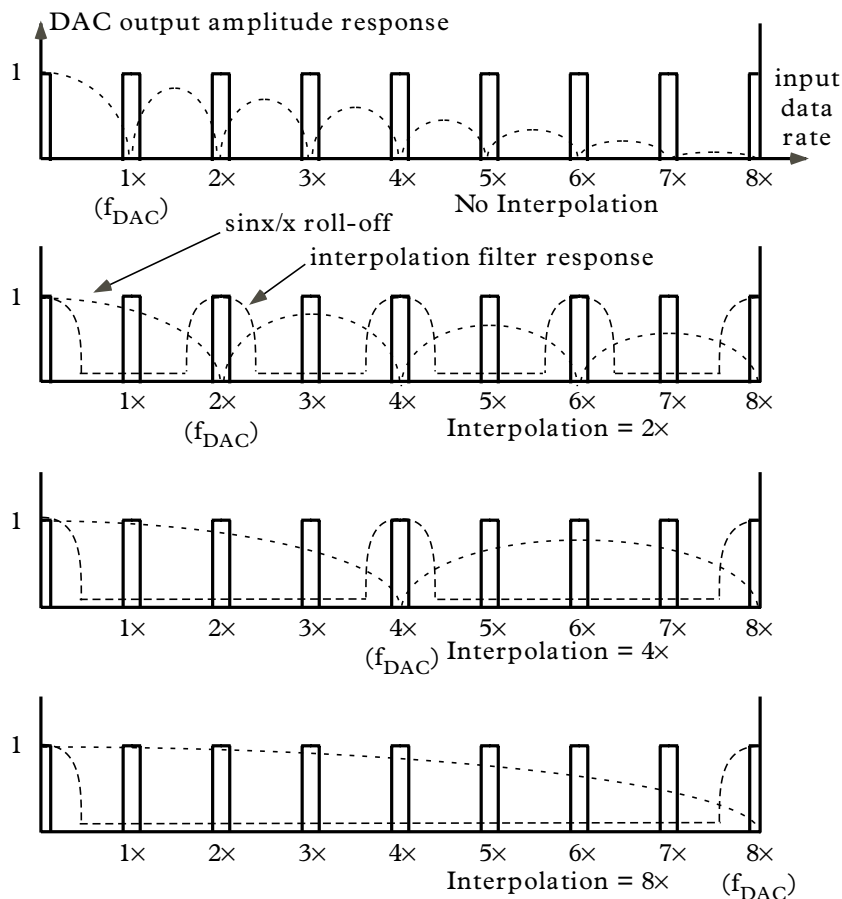

Figure 9. Effect of Interpolation Rate on Sinc/x and DAC Output Spectrum, Modulation Function turned off

INTERPOLATING (REAL MIX MODULATION)

The digital modulators in the AD9777 can be enabled by setting control register 01h, bits 5 and 4, to correspond to the desired $f_s/2$, $f_s/4$, $f_s/8$ modulation mode (see register descriptions on page 11). Real mix mode is enabled by setting control register 01h, bit 2, to a logic 1. In this mode, the modulators act individually on each data path, with no complex mixing between modulators.

AMPLITUDE MODULATION

Given two sine waves at the same frequency, but with a 90 phase difference, a point of view in time can be taken such the waveform which leads in phase is cosinusoidal, and the waveform which lags is sinusoidal. Analysis of complex variables states that the cosine waveform can be defined as having real positive and negative frequency components, while the sine waveform consists of imaginary positive and negative frequency images. This shown graphically in the frequency domain in figure 10.

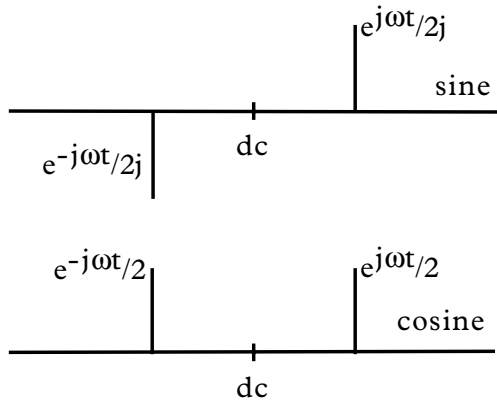

Figure 10. Real and Imaginary Components of Sinusoidal and Cosinusoidal Waveforms.

Amplitude modulating a baseband signal with a sine or a cosine convolves the baseband signal with the modulating carrier in the frequency domain. Amplitude scaling of the modulated signal reduces the positive and negative frequency images by a factor of two. This scaling will be very important in the discussion of the various modulation modes. The phase relationship of the modulated signals is dependent on whether the modulating carrier is sine or cosinusoidal, again with respect to the reference point of the viewer. Examples of sine and cosine modulation are given in figure 11.

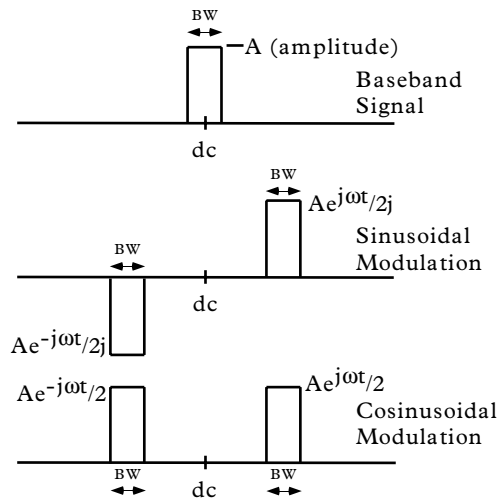

Figure 11. Baseband Signal, Amplitude Modulated with Sine and Cosine Carriers.

($f_{DAC}/2$ MODULATION)

With control register 01h, bits five and four, set to 01, the digital modulators on the AD9777 are set to $f_{DAC}/2$. This modulation mode is unique in that the factor of two scaling of modulated images does not occur. This is due to the fact that the positive and negative frequency images which result from the modulation add constructively, independent of the interpolation rate. Figure 12 represents the spectral response of the AD9777, in the $f_{DAC}/2$ modulation mode, to a baseband signal identical to that described in Figure 9. A significant point to understand from is that the interpolation filtering is done previous to the modulation. For this reason, as Figure 12 shows, the passband of the interpolation filters has shifted, giving the equivalent of a high pass digital filter.

($f_{DAC}/4$ MODULATION)

With control register 01h, bits five and four, set to 10, the digital modulators on the AD9777 are set to $f_{DAC}/4$. Similar to the $f_{DAC}/2$ modulation mode, this mode can be used to attain a high pass filter response. Distortion performance will be improved vs. $f_{DAC}/2$ modulation as the incremental steps in the modulator will be of a smaller amplitude. However, scaling by a factor of two, as mentioned earlier, does occur, as there is no constructive addition of images. Also, the images appear closer together than in the corresponding $f_{DAC}/2$ mode, making the implementation of the reconstruction filter more difficult.

($f_{DAC}/8$ MODULATION)

With control register 01h, bits five and four, set to 11, the digital modulators on the AD9777 are set to $f_{DAC}/8$. Again, this is similar to the $f_{DAC}/4$ modulation mode, with improved distortion performance. Factor of two scaling occurs as well. In addition, care must be taken

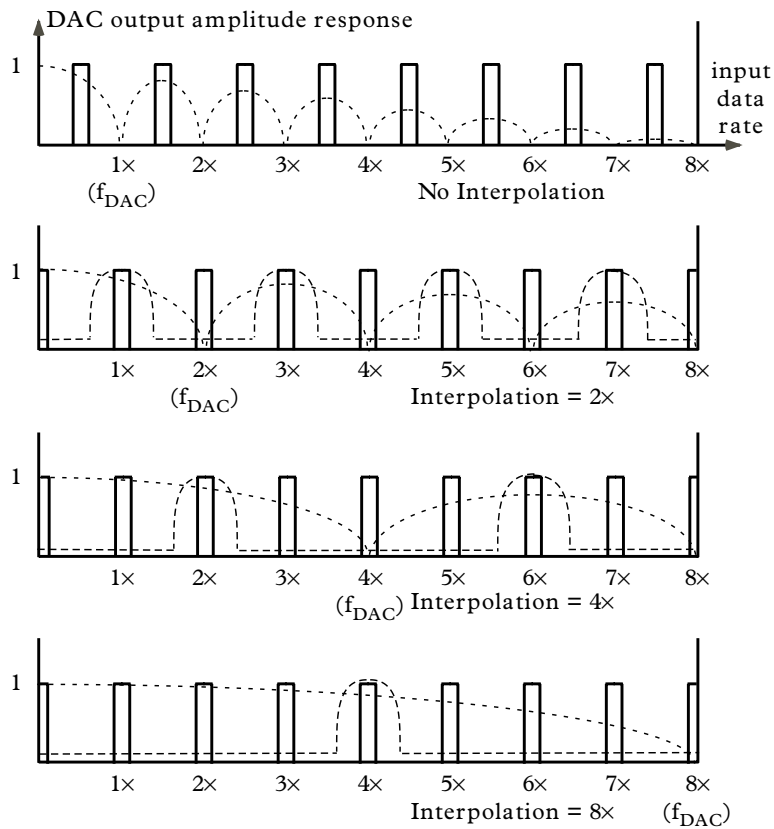

Figure 12. Effect of Interpolation Rate on Sinx/x and DAC Output Spectrum with $f_{DAC}/2$ Modulation

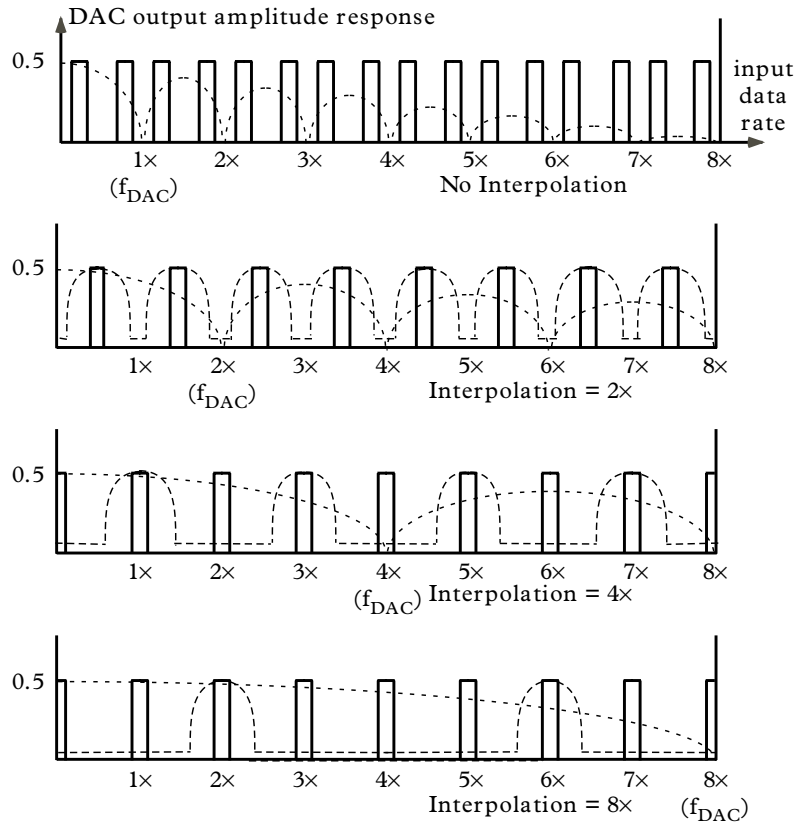

Figure 13. Effect of Interpolation Rate on Sinx/x and DAC Output Spectrum with $f_{DAC}/4$ Modulation

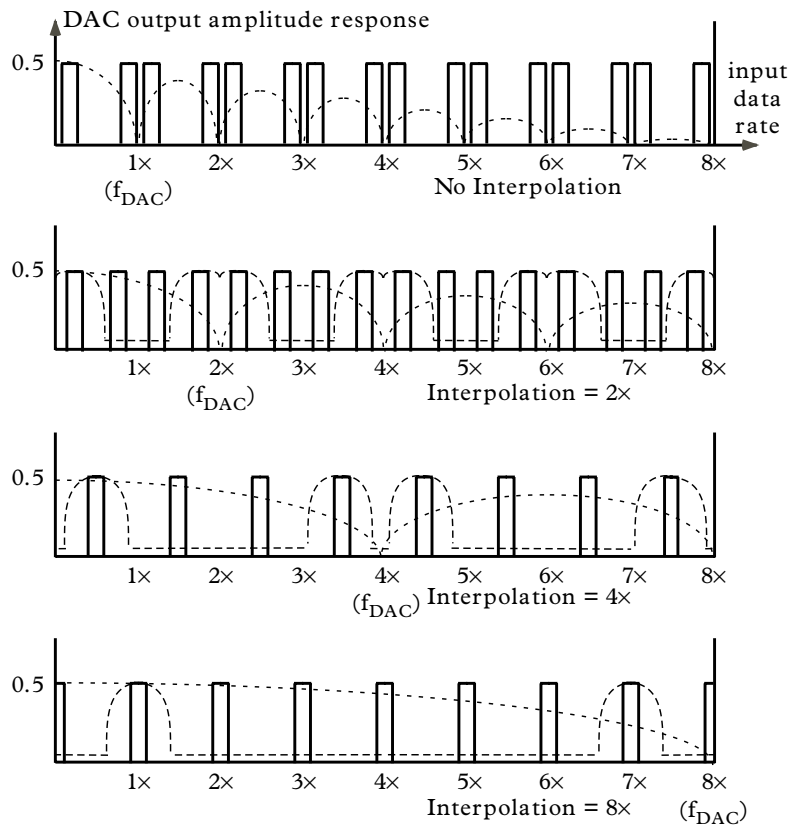

Figure 14. Effect of Interpolation Rate on Sinx/x and DAC Output Spectrum with $8\times$ Modulation

in frequency selection when interpolating by two as overlap can occur between passband frequency regions, resulting in aliasing.

INTERPOLATING (COMPLEX MIX MODE)

Complex Modulation is enabled by setting control register 01h, bit 2, to a logic 0. In this mode the two digital modulators on the AD9777 are coupled to provide a complex modulation function. In conjunction with an external quadrature modulator, this complex modulation can be used to realize a transmit image rejection architecture. The complex modulation function can be programmed for $e^{+j\omega t}$ or $e^{-j\omega t}$ to give upper or lower image rejection. The modulation frequency ω can be programmed via the SPI port for $f_s/2$, $f_s/4$ and $f_s/8$, where f_s represents the DAC output rate.

OPERATIONS ON COMPLEX SIGNALS

Truly complex signals can not be realized outside of a computer simulation. However, two data channels, both consisting of real data, can be defined as the real and imaginary components of a complex signal. I (real) and

Q (imaginary) data paths are often defined this way. By using the architecture defined in figure 15, a system can be realized which operates on complex signals, giving a complex (real and imaginary) output.

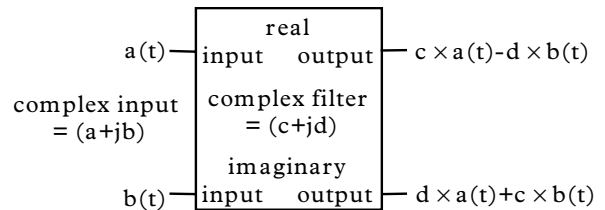

Figure 15. Realization of a Complex System

If a complex modulation function ($e^{+j\omega t}$) is desired, the real and imaginary components of the system correspond to the real and imaginary components of $e^{+j\omega t}$, or $\cos\omega t$ and $\sin\omega t$. As Figure 16 shows, the complex modulation function can be realized by applying these components to the structure of the complex system defined in Figure 15.

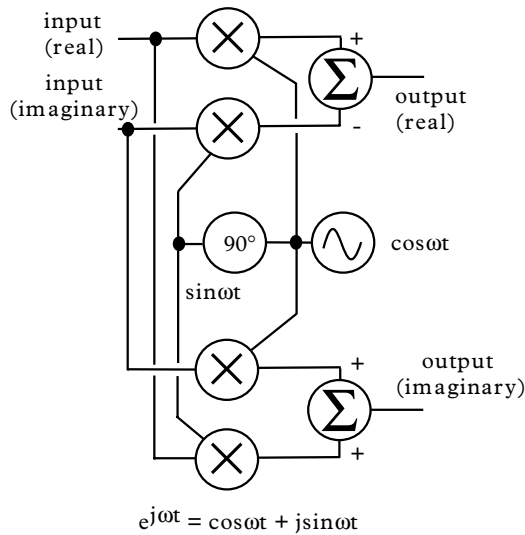

Figure 16. Implementation of Complex Modulator

COMPLEX MODULATION AND IMAGE REJECTION OF BASEBAND SIGNALS

In traditional transmit applications, a two step upconversion is done in which a baseband signal is modulated by one carrier to an IF (intermediate frequency) and then modulated a second time to the transmit frequency. Although this approach has several benefits, a major drawback is that two images are created near the transmit frequency. Only one image is needed, the other being an exact duplicate. Unless the unwanted image is filtered, typically with analog components, transmit power is wasted and the usable bandwidth available in the system is reduced.

A more efficient method of suppressing the unwanted image can be achieved by using a complex modulator followed by a quadrature modulator. Figure 17 shows a block diagram of a quadrature modulator. Note that it is in fact the real output half of a complex modulator. The complete upconversion can actually be referred to as two complex upconversion stages, the real output of which becomes the transmitted signal.

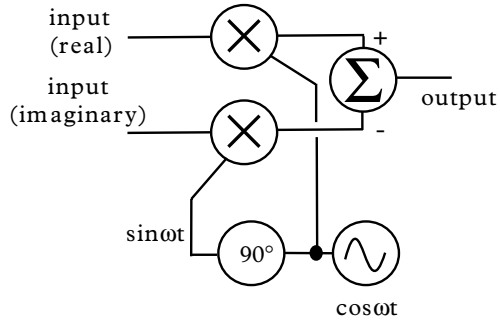

Figure 17. Quadrature Modulator

The entire upconversion, from baseband to transmit frequency, is represented graphically in figure 18. The resulting spectrum shown in figure 18 represents the complex data consisting of the baseband real and imaginary channels, now modulated onto orthogonal (cosine and negative sine) carriers at the transmit frequency. It is important to remember that in this application (two baseband data channels) that the image rejection is not dependent on the data at either of the

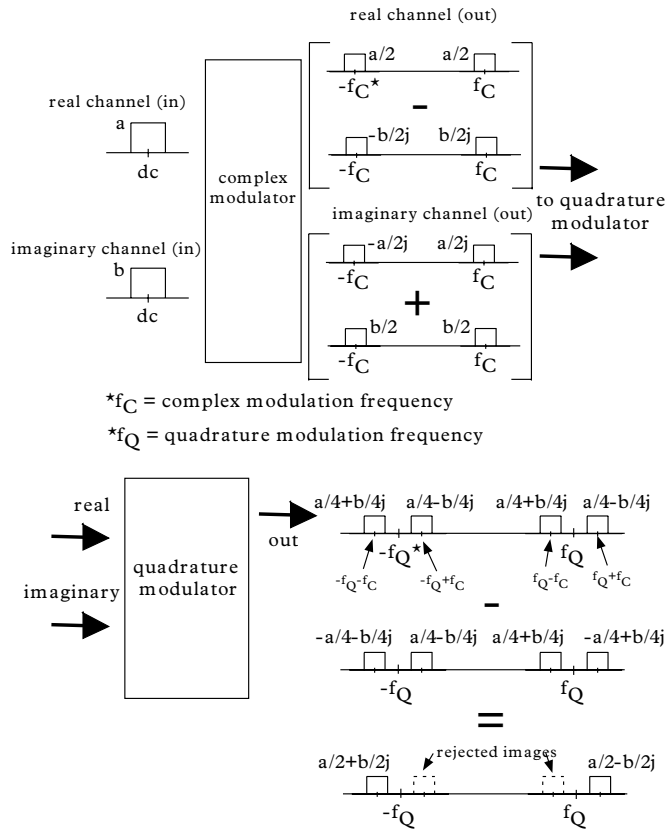

Figure 18. Two Stage Upconversion and Resulting Image Rejection

AD9777 input channels. In fact, image rejection will still occur with either one or both of the AD9777 input channels active. Note that by changing the sign of the sinusoidal multiplying term in the complex modulator, the upper sideband image could have been suppressed while passing the lower one. This is easily done in the AD9777 by selecting the $e^{+j\omega t}$ bit (register 01h, bit 1).

In purely complex terms, figure 19 represents the two stage upconversion from complex baseband to carrier. In this example, ω_C and ω_Q represent the modulation frequencies of the digital complex modulator and the quadrature modulator.

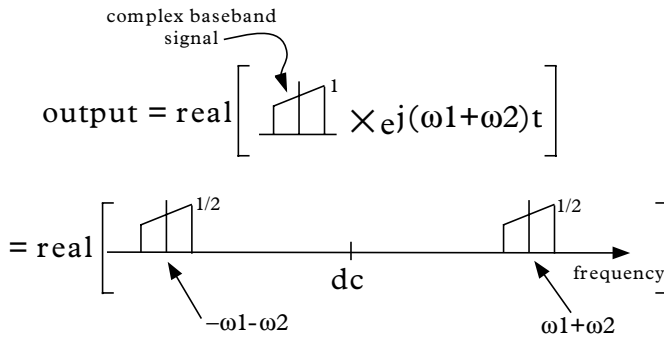

Figure 19. Two Stage Complex Upconversion

IMAGE REJECTION AND SIDEBAND SUPPRESSION OF MODULATED CARRIERS

As described in Figure 18, image rejection can be achieved by applying baseband data to the AD9777 and following the AD9777 with a quadrature modulator. To process multiple carriers, while still maintaining image reject capability, a digital complex modulator must be added in the signal chain. As Figure 20 shows, a single or multiple modulators can be used to synthesize complex carriers. These complex carriers are then summed and applied to the real and imaginary inputs of the AD9777. A system in which multiple baseband signals are complex modulated and then applied to the AD9777 real and imaginary inputs, followed by a quadrature modulator, is shown in Figure 21, which also describes the transfer function of this system and the spectral output. Note the similarity of the transfer functions given in Figure 21 and Figure 19. Figure 21 adds an additional complex modulator stage for the purpose of summing multiple carriers at the AD9777 inputs. Also, as in Figure 18, the image rejection is not dependent on the real or imaginary baseband data on any channel. Image rejection on a channel will occur if either the real or imaginary data, or both, is present on the baseband channel.

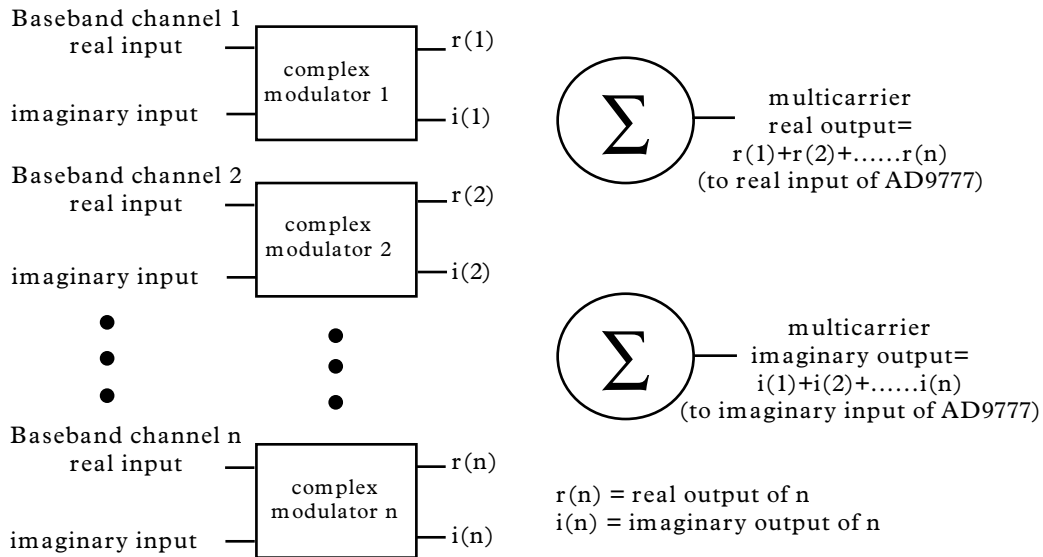

Figure 20. Synthesis of Multicarrier Complex Signal

AD9777

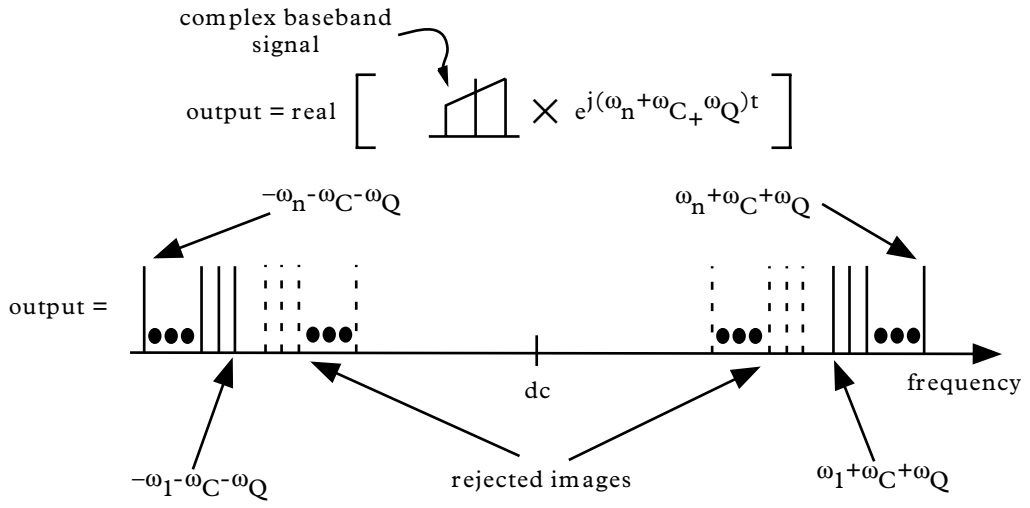
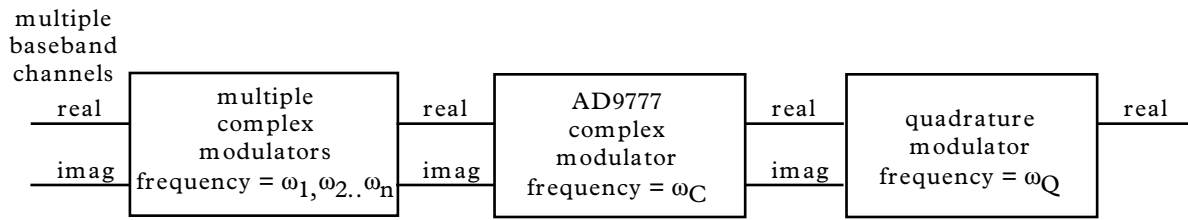

Figure 21. Image Rejection with Multicarrier Signals

ST-80A
80-Lead Thin Plastic Quad Flatpack - 1.4mm Thick [LQFP]

