

### FEATURES

**Dual 8-Bit, 40 MSPS, 80 MSPS, and 100 MSPS ADC**  
**Low Power: 90 mW at 100 MSPS per Channel**  
**On-Chip Reference and Track/Holds**  
**475 MHz Analog Bandwidth Each Channel**  
**SNR = 47 dB @ 41 MHz**  
**1 V p-p Analog Input Range Each Channel**  
**Single 3.0 V Supply Operation (2.7 V to 3.6 V)**  
**Standby Mode for Single Channel Operation**  
**Two's Complement or Offset Binary Output Mode**  
**Output Data Alignment Mode**  
**Pin-Compatible 10-Bit Upgrade Available**

### APPLICATIONS

**Battery-Powered Instruments**  
**Hand-Held Scopemeters**  
**Low Cost Digital Oscilloscopes**  
**I and Q Communications**

### GENERAL DESCRIPTION

The AD9288 is a dual 8-bit monolithic sampling analog-to-digital converter with on-chip track-and-hold circuits and is optimized for low cost, low power, small size, and ease of use. The product operates at a 100 MSPS conversion rate with outstanding dynamic performance over its full operating range. Each channel can be operated independently.

The ADC requires only a single 3.0 V (2.7 V to 3.6 V) power supply and an encode clock for full-performance operation. No external reference or driver components are required for many applications. The digital outputs are TTL/CMOS-compatible and a separate output power supply pin supports interfacing with 3.3 V or 2.5 V logic.

### FUNCTIONAL BLOCK DIAGRAM

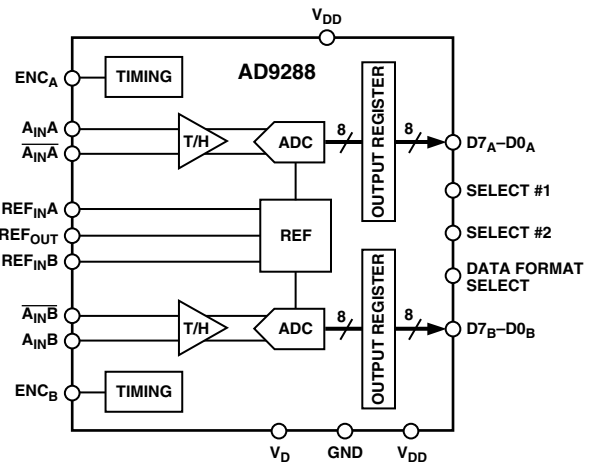

The encode input is TTL/CMOS-compatible and the 8-bit digital outputs can be operated from 3.0 V (2.5 V to 3.6 V) supplies. User-selectable options are available to offer a combination of standby modes, digital data formats and digital data timing schemes. In standby mode, the digital outputs are driven to a high impedance state.

Fabricated on an advanced CMOS process, the AD9288 is available in a 48-lead surface mount plastic package (7 × 7 mm, 1.4 mm LQFP) specified over the industrial temperature range (−40°C to +85°C). The AD9288 is pin-compatible with the 10-bit AD9218, facilitating future system migrations.

### REV. A

Information furnished by Analog Devices is believed to be accurate and reliable. However, no responsibility is assumed by Analog Devices for its use, nor for any infringements of patents or other rights of third parties which may result from its use. No license is granted by implication or otherwise under any patent or patent rights of Analog Devices.

# AD9288—SPECIFICATIONS ( $V_{DD} = 3.0\text{ V}$ ; $V_D = 3.0\text{ V}$ , Differential Input; External reference unless otherwise noted.)

Parameter	Temp	Test Level	AD9288BST-100			AD9288BST-80			AD9288BST-40			Unit
			Min	Typ	Max	Min	Typ	Max	Min	Typ	Max	
RESOLUTION			8			8			8			Bits
DC ACCURACY												
Differential Nonlinearity	25°C	I		±0.5	+1.25		±0.5	+1.25		±0.5	+1.25	LSB
	Full	VI			1.50			1.50			1.50	LSB
Integral Nonlinearity	25°C	I		±0.50	+1.25		±0.50	+1.25		±0.50	+1.25	LSB
	Full	VI			1.50			1.50			1.50	LSB
No Missing Codes	Full	VI	Guaranteed			Guaranteed			Guaranteed			
Gain Error <sup>1</sup>	25°C	I	-6	±2.5	+6	-6	±2.5	+6	-6	±2.5	+6	% FS
	Full	VI	-8		+8	-8		+8	-8		+8	% FS
Gain Tempco <sup>1</sup>	Full	VI		80			80			80		ppm/°C
Gain Matching	25°C	V		±1.5			±1.5			±1.5		% FS
Voltage Matching	25°C	V		±15			±15			±15		mV
ANALOG INPUT												
Input Voltage Range (With Respect to $\overline{A_{IN}}$ )	Full	V		±512			±512			±512		mV p-p
Common-Mode Voltage	Full	V	$0.3 \times V_D$ -0.2	$0.3 \times V_D$	$0.3 \times V_D$ +0.2	$0.3 \times V_D$ -0.2	$0.3 \times V_D$	$0.3 \times V_D$ +0.2	$0.3 \times V_D$ -0.2	$0.3 \times V_D$	$0.3 \times V_D$ +0.2	V
Input Offset Voltage	25°C	I	-35	±10	+35	-35	±10	+35	-35	±10	+35	mV
	Full	VI	-40		+40	-40		+40	-40		+40	mV
Reference Voltage	Full	VI	1.2	1.25	1.3	1.2	1.25	1.3	1.2	1.25	1.3	V
Reference Tempco	Full	VI		±130			±130			±130		ppm/°C
Input Resistance	25°C	I	7	10	13	7	10	13	7	10	13	kΩ
	Full	VI	5		16	5		16	5		16	kΩ
Input Capacitance	25°C	V		2			2			2		pF
Analog Bandwidth, Full Power	25°C	V		475			475			475		MHz
SWITCHING PERFORMANCE												
Maximum Conversion Rate	Full	VI	100			80			40			MSPS
Minimum Conversion Rate	25°C	IV		1			1			1		MSPS
Encode Pulsewidth High ( $t_{EH}$ )	25°C	IV	4.3		1000	5.0		1000	8.0		1000	ns
Encode Pulsewidth Low ( $t_{EL}$ )	25°C	IV	4.3		1000	5.0		1000	8.0		1000	ns
Aperture Delay ( $t_A$ )	25°C	V		300			300			300		ps
Aperture Uncertainty (Jitter)	25°C	V		5			5			5		ps rms
Output Valid Time ( $t_V$ ) <sup>2</sup>	Full	VI	2	3.0		2	3.0		2	3.0		ns
Output Propagation Delay ( $t_{PD}$ ) <sup>2</sup>	Full	VI		4.5	6.0		4.5	6.0		4.5	6.0	ns
DIGITAL INPUTS												
Logic "1" Voltage	Full	VI	2.0			2.0			2.0			V
Logic "0" Voltage	Full	VI			0.8			0.8			0.8	V
Logic "1" Current	Full	VI			±1			±1			±1	μA
Logic "0" Current	Full	VI			±1			±1			±1	μA
Input Capacitance	25°C	V		2.0			2.0			2.0		pF
DIGITAL OUTPUTS <sup>3</sup>												
Logic "1" Voltage	Full	VI	2.45			2.45			2.45			V
Logic "0" Voltage	Full	VI			0.05			0.05			0.05	V
POWER SUPPLY												
Power Dissipation <sup>4</sup>	Full	VI		180	218		171	207		156	189	mW
Standby Dissipation <sup>4,5</sup>	Full	VI		6	11		6	11		6	11	mW
Power Supply Rejection Ratio (PSRR)	25°C	I		8	20		8	20		8	20	mV/V
DYNAMIC PERFORMANCE <sup>6</sup>												
Transient Response	25°C	V		2			2			2		ns
Overvoltage Recovery Time	25°C	V		2			2			2		ns
Signal-to-Noise Ratio (SNR) (Without Harmonics)												
$f_N = 10.3\text{ MHz}$	25°C	I		47.5			47.5		44	47.5		dB
$f_N = 26\text{ MHz}$	25°C	I		47.5		44	47					dB
$f_N = 41\text{ MHz}$	25°C	I	44	47.0								dB

Parameter	Temp	Test Level	AD9288BST-100			AD9288BST-80			AD9288BST-40			Unit
			Min	Typ	Max	Min	Typ	Max	Min	Typ	Max	
DYNAMIC PERFORMANCE <sup>6</sup> (Continued)												
Signal-to-Noise Ratio (SINAD) (With Harmonics)												
$f_{IN} = 10.3$ MHz	25°C	I		47		47		44	47			dB
$f_{IN} = 26$ MHz	25°C	I		47		47	44	47				dB
$f_{IN} = 41$ MHz	25°C	I	44	47		47						dB
Effective Number of Bits												
$f_{IN} = 10.3$ MHz	25°C	I		7.5		7.5		7.0	7.5			Bits
$f_{IN} = 26$ MHz	25°C	I		7.5		7.5	7.0	7.5				Bits
$f_{IN} = 41$ MHz	25°C	I	7.0	7.5		7.5						Bits
2nd Harmonic Distortion												
$f_{IN} = 10.3$ MHz	25°C	I		70		70		55	70			dBc
$f_{IN} = 26$ MHz	25°C	I		70		70	55	70				dBc
$f_{IN} = 41$ MHz	25°C	I	55	70		70						dBc
3rd Harmonic Distortion												
$f_{IN} = 10.3$ MHz	25°C	I		60		60		55	60			dBc
$f_{IN} = 26$ MHz	25°C	I		60		60	55	60				dBc
$f_{IN} = 41$ MHz	25°C	I	52	60		60						dBc
Two-Tone Intermod Distortion (IMD)												
$f_{IN} = 10.3$ MHz	25°C	V		60		60			60			dBc

## NOTES

<sup>1</sup>Gain error and gain temperature coefficient are based on the ADC only (with a fixed 1.25 V external reference).

<sup>2</sup> $t_{V}$  and  $t_{PD}$  are measured from the 1.5 V level of the ENCODE input to the 10%/90% levels of the digital outputs swing. The digital output load during test is not to exceed an ac load of 10 pF or a dc current of  $\pm 40$   $\mu$ A.

<sup>3</sup>Digital supply current based on  $V_{DD} = 3.0$  V output drive with <10 pF loading under dynamic test conditions.

<sup>4</sup>Power dissipation measured under the following conditions:  $f_S = 100$  MSPS, analog input is  $-0.7$  dBFS, both channels in operation.

<sup>5</sup>Standby dissipation calculated with encode clock in operation.

<sup>6</sup>SNR/harmonics based on an analog input voltage of  $-0.7$  dBFS referenced to a 1.024 V full-scale input range.

Specifications subject to change without notice.

## ABSOLUTE MAXIMUM RATINGS\*

$V_D, V_{DD}$	4 V
Analog Inputs	$-0.5$ V to $V_D + 0.5$ V
Digital Inputs	$-0.5$ V to $V_{DD} + 0.5$ V
VREF IN	$-0.5$ V to $V_D + 0.5$ V
Digital Output Current	20 mA
Operating Temperature	$-55^\circ\text{C}$ to $+125^\circ\text{C}$
Storage Temperature	$-65^\circ\text{C}$ to $+150^\circ\text{C}$
Maximum Junction Temperature	$175^\circ\text{C}$
Maximum Case Temperature	$150^\circ\text{C}$

\*Stresses above those listed under Absolute Maximum Ratings may cause permanent damage to the device. This is a stress rating only; functional operation of the device at these or any other conditions outside of those indicated in the operation sections of this specification is not implied. Exposure to absolute maximum ratings for extended periods may affect device reliability.

## EXPLANATION OF TEST LEVELS

## Test Level

- I 100% production tested.
- II 100% production tested at 25°C and sample tested at specified temperatures.
- III Sample tested only.
- IV Parameter is guaranteed by design and characterization testing.
- V Parameter is a typical value only.
- VI 100% production tested at 25°C; guaranteed by design and characterization testing for industrial temperature range; 100% production tested at temperature extremes for military devices.

## ORDERING GUIDE

Model	Temperature Ranges	Package Options
AD9288BST		
-40, -80, -100	$-40^\circ\text{C}$ to $+85^\circ\text{C}$	ST-48*
AD9288/PCB	25°C	Evaluation Board

\*ST = Thin Plastic Quad Flatpack (1.4 mm thick, 7 × 7 mm: LQFP).

Table I. User Select Options

S1	S2	User Select Options
0	0	Standby Both Channels A and B.
0	1	Standby Channel B Only.
1	0	Normal Operation (Data Align Disabled).
1	1	Data align enabled (data from both channels available on rising edge of Clock A. Channel B data is delayed a 1/2 clock cycle).

## CAUTION

ESD (electrostatic discharge) sensitive device. Electrostatic charges as high as 4000 V readily accumulate on the human body and test equipment and can discharge without detection. Although the AD9288 features proprietary ESD protection circuitry, permanent damage may occur on devices subjected to high-energy electrostatic discharges. Therefore, proper ESD precautions are recommended to avoid performance degradation or loss of functionality.



# AD9288

## PIN CONFIGURATION

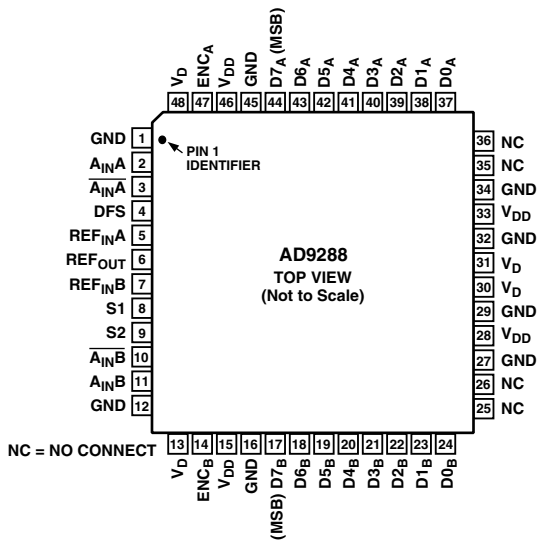

## PIN FUNCTION DESCRIPTIONS

Pin No.	Name	Description
1, 12, 16, 27, 29, 32, 34, 45	GND	Ground.
2	$A_{INA}$	Analog Input for Channel A.
3	$\overline{A}_{INA}$	Analog Input for Channel A (Complementary).
4	DFS	Data Format Select: (Offset binary output available if set low. Twos complement output available if set high).
5	$REF_{INA}$	Reference Voltage Input for Channel A.
6	$REF_{OUT}$	Internal Reference Voltage.
7	$REF_{INB}$	Reference Voltage Input for Channel B.
8	S1	User Select #1 (Refer to Table I), Tied with Respect to $V_D$ .
9	S2	User Select #2 (Refer to Table I), Tied with Respect to $V_D$ .
10	$\overline{A}_{INB}$	Analog Input for Channel B (Complementary).
11	$A_{INB}$	Analog Input for Channel B.
13, 30, 31, 48	$V_D$	Analog Supply (3 V).
14	$ENC_B$	Clock Input for Channel B.
15, 28, 33, 46	$V_{DD}$	Digital Supply (3 V).
17–24	$D7_B-D0_B$	Digital Output for Channel B.
25, 26, 35, 36	NC	Do Not Connect.
37–44	$D0_A-D7_A$	Digital Output for Channel A.
47	$ENC_A$	Clock Input for Channel A.

## DEFINITION OF SPECIFICATIONS

### Analog Bandwidth (Small Signal)

The analog input frequency at which the spectral power of the fundamental frequency (as determined by the FFT analysis) is reduced by 3 dB.

### Aperture Delay

The delay between a differential crossing of ENCODE and ENCODE and the instant at which the analog input is sampled.

### Aperture Uncertainty (Jitter)

The sample-to-sample variation in aperture delay.

### Differential Nonlinearity

The deviation of any code from an ideal 1 LSB step.

### Encode Pulsewidth/Duty Cycle

Pulsewidth high is the minimum amount of time that the ENCODE pulse should be left in Logic “1” state to achieve rated performance; pulsewidth low is the minimum time ENCODE pulse should be left in low state. At a given clock rate, these specs define an acceptable Encode duty cycle.

### Integral Nonlinearity

The deviation of the transfer function from a reference line measured in fractions of 1 LSB using a “best straight line” determined by a least square curve fit.

### Minimum Conversion Rate

The encode rate at which the SNR of the lowest analog signal frequency drops by no more than 3 dB below the guaranteed limit.

### Maximum Conversion Rate

The encode rate at which parametric testing is performed.

### Output Propagation Delay

The delay between a differential crossing of ENCODE and ENCODE and the time when all output data bits are within valid logic levels.

### Power Supply Rejection Ratio

The ratio of a change in input offset voltage to a change in power supply voltage.

### Signal-to-Noise-and-Distortion (SINAD)

The ratio of the rms signal amplitude (set at 1 dB below full scale) to the rms value of the sum of all other spectral components, including harmonics but excluding dc.

### Signal-to-Noise Ratio (SNR)

The ratio of the rms signal amplitude (set at 1 dB below full scale) to the rms value of the sum of all other spectral components, excluding the first five harmonics and dc.

### Spurious-Free Dynamic Range (SFDR)

The ratio of the rms signal amplitude to the rms value of the peak spurious spectral component. The peak spurious component may or may not be a harmonic. May be reported in dBc (i.e., degrades as signal levels is lowered), or in dBFS (always related back to converter full scale).

### Two-Tone Intermodulation Distortion Rejection

The ratio of the rms value of either input tone to the rms value of the worst third order intermodulation product; reported in dBc.

### Two-Tone SFDR

The ratio of the rms value of either input tone to the rms value of the peak spurious component. The peak spurious component may or may not be an IMD product. May be reported in dBc (i.e., degrades as signal levels is lowered), or in dBFS (always related back to converter full scale).

### Worst Harmonic

The ratio of the rms signal amplitude to the rms value of the worst harmonic component, reported in dBc.

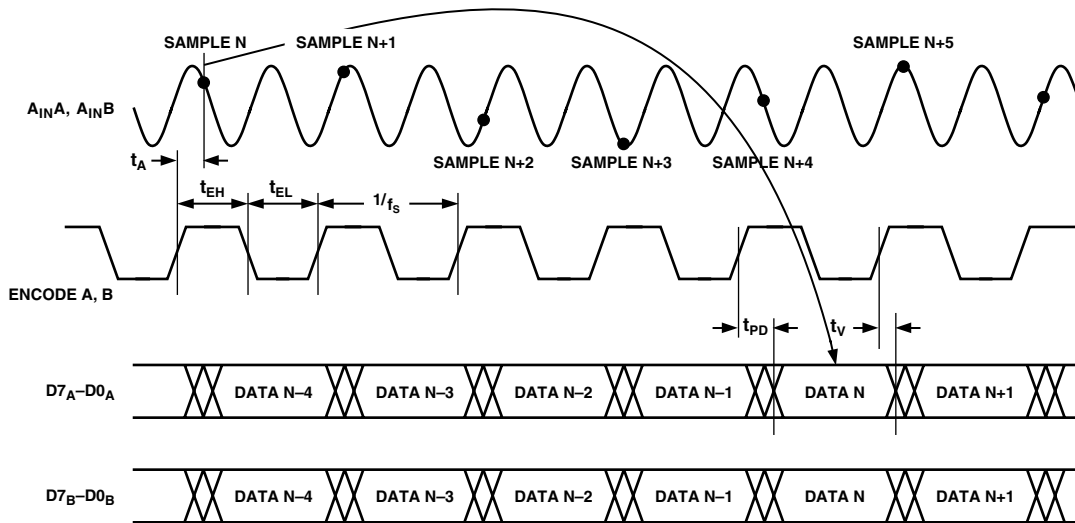

Figure 1. Normal Operation, Same Clock ( $S1 = 1, S2 = 0$ ) Channel Timing

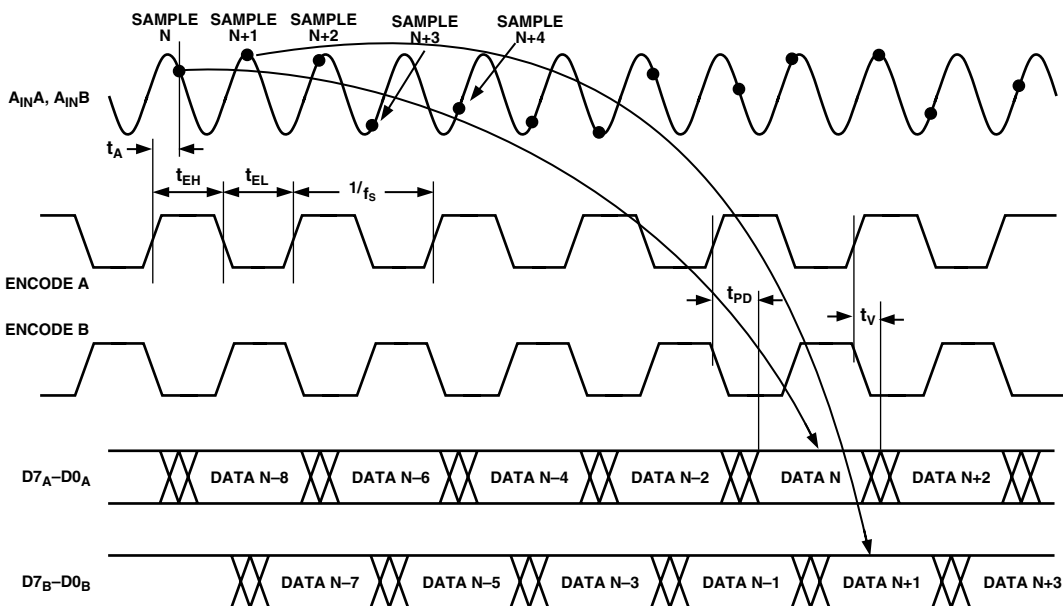

Figure 2. Normal Operation with Two Clock Sources ( $S1 = 1, S2 = 0$ ) Channel Timing

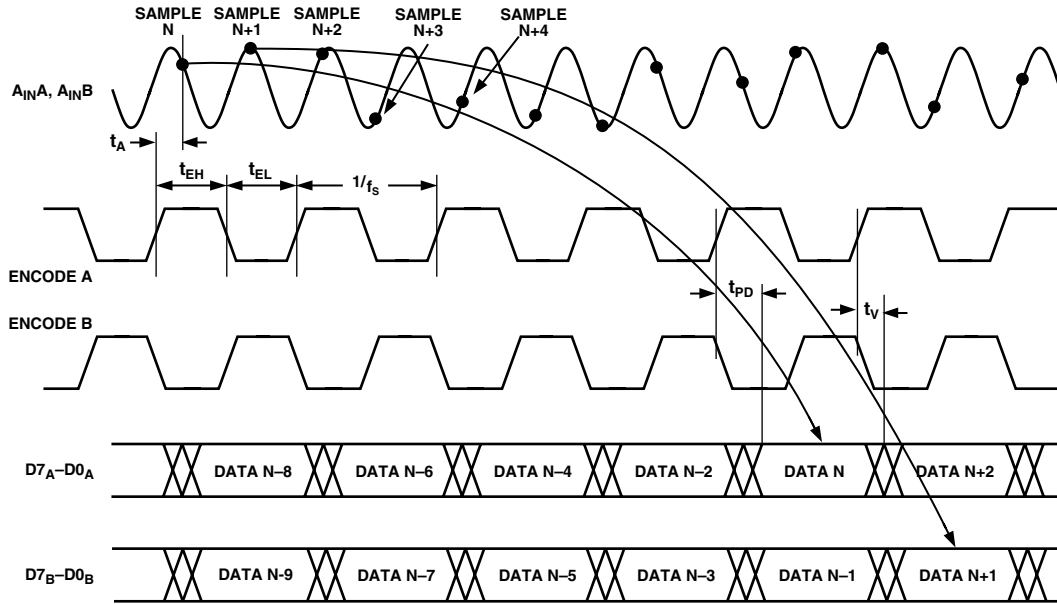
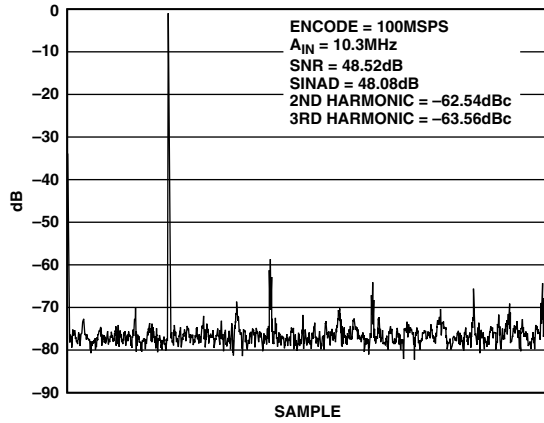
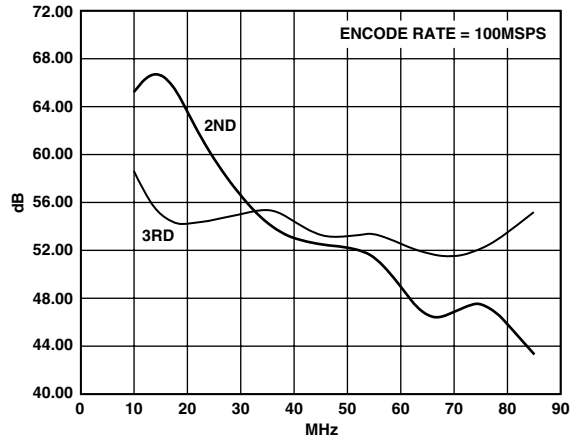

Figure 3. Data Align with Two Clock Sources ( $S1 = 1, S2 = 1$ ) Channel Timing

# Typical Performance Characteristics—AD9288



TPC 1. Spectrum:  $f_S = 100\text{ MSPS}$ ,  $f_{IN} = 10\text{ MHz}$ , Single-Ended Input



TPC 4. Harmonic Distortion vs.  $A_{IN}$  Frequency

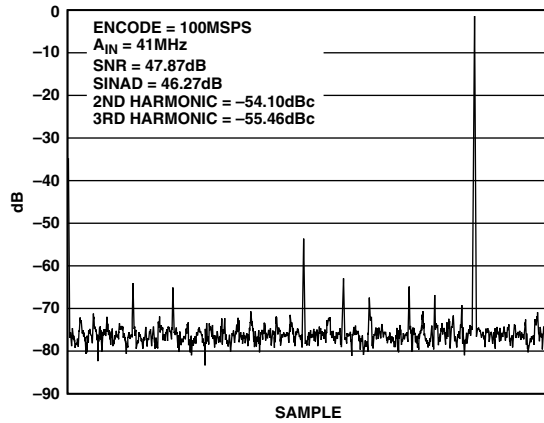

TPC 2. Spectrum:  $f_S = 100\text{ MSPS}$ ,  $f_{IN} = 41\text{ MHz}$ , Single-Ended Input

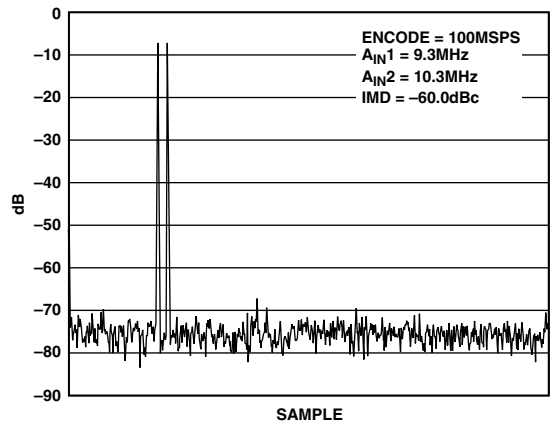

TPC 5. Two-Tone Intermodulation Distortion

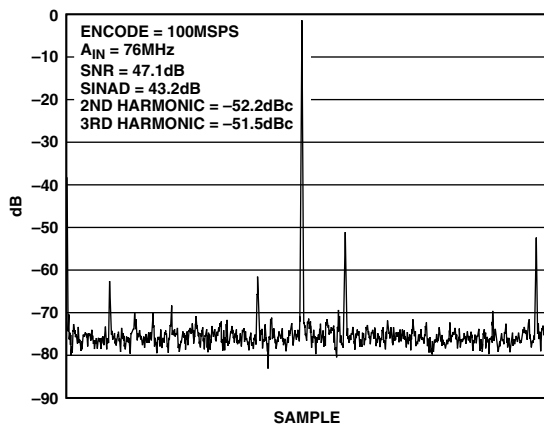

TPC 3. Spectrum:  $f_S = 100\text{ MSPS}$ ,  $f_{IN} = 76\text{ MHz}$ , Single-Ended Input

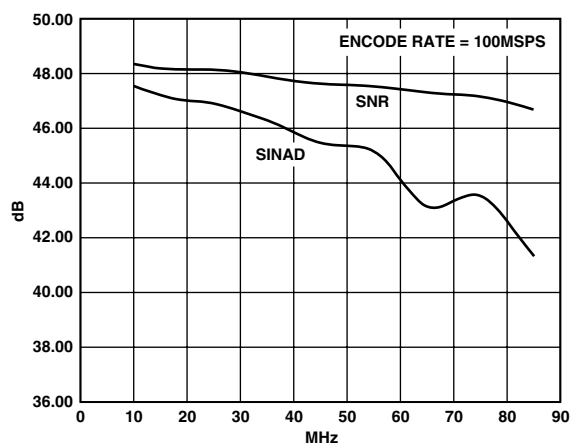

TPC 6. SINAD/SNR vs.  $A_{IN}$  Frequency

# AD9288

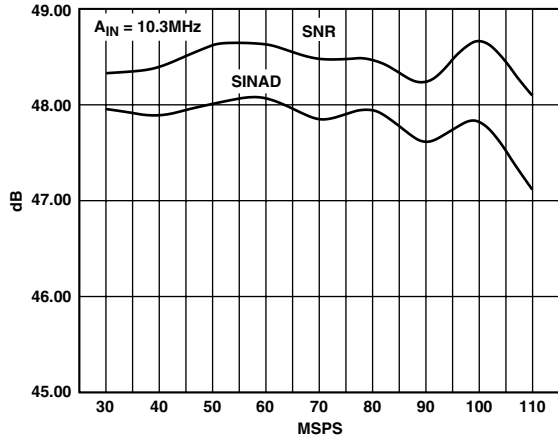

TPC 7. SINAD/SNR vs. Encode Rate

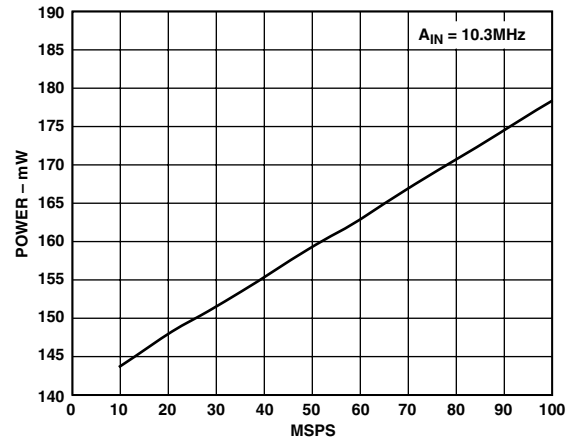

TPC 10. Analog Power Dissipation vs. Encode Rate

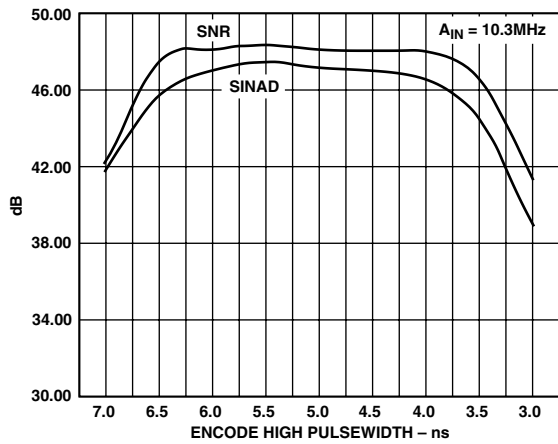

TPC 8. SINAD/SNR vs. Encode Pulsewidth High

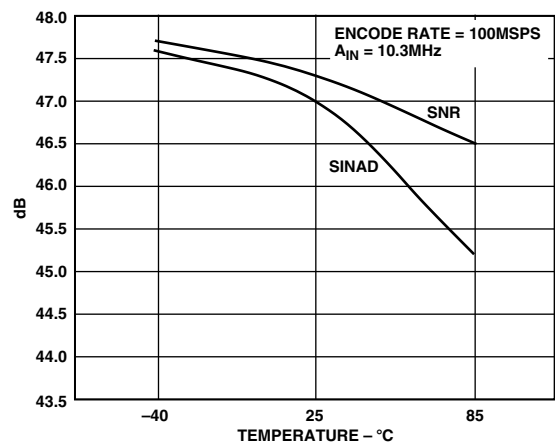

TPC 11. SINAD/SNR vs. Temperature

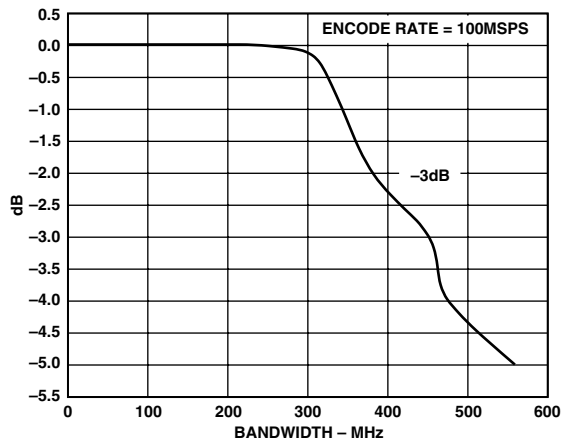

TPC 9. ADC Frequency Response:  $f_s = 100$  MSPS

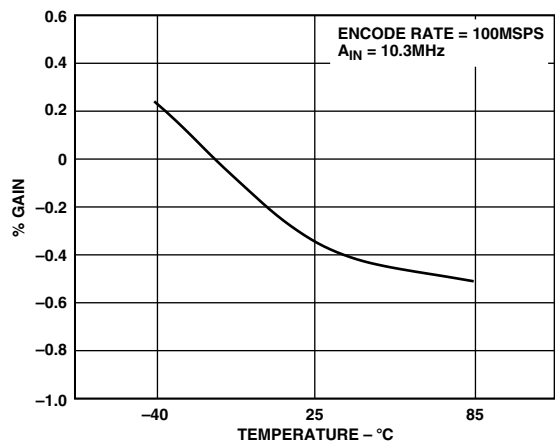

TPC 12. ADC Gain vs. Temperature (with External 1.25 V Reference)



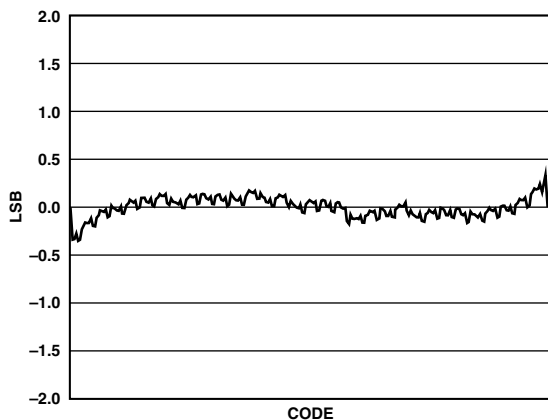

TPC 13. Integral Nonlinearity

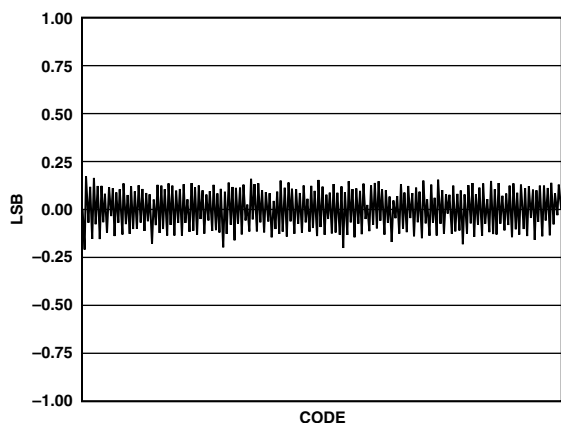

TPC 14. Differential Nonlinearity

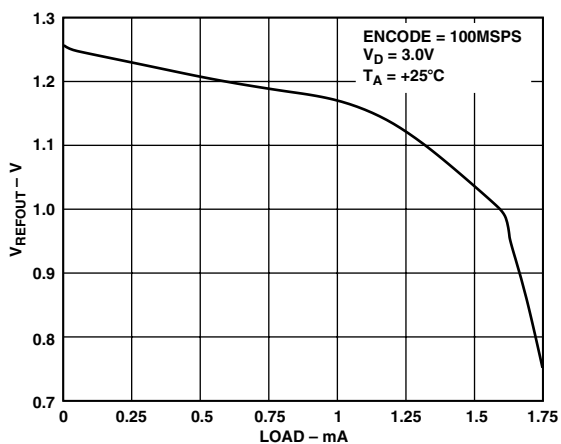

TPC 15. Voltage Reference Out vs. Current Load

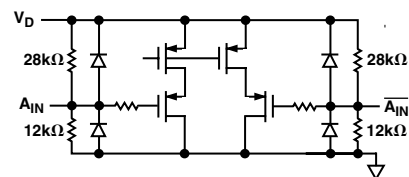

TPC 16. Equivalent Analog Input Circuit

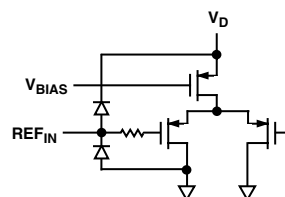

TPC 17. Equivalent Reference Input Circuit

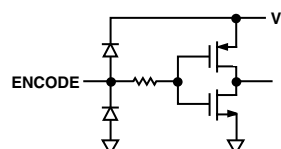

TPC 18. Equivalent Encode Input Circuit

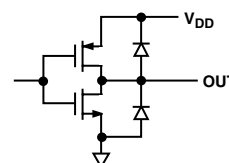

TPC 19. Equivalent Digital Output Circuit

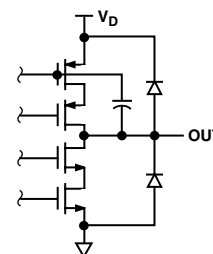

TPC 20. Equivalent Reference Output Circuit

# AD9288

## APPLICATION NOTES

### THEORY OF OPERATION

The AD9288 ADC architecture is a bit-per-stage pipeline-type converter utilizing switch capacitor techniques. These stages determine the 5 MSBs and drive a 3-bit flash. Each stage provides sufficient overlap and error correction allowing optimization of comparator accuracy. The input buffers are differential and both sets of inputs are internally biased. This allows the most flexible use of ac or dc and differential or single-ended input modes. The output staging block aligns the data, carries out the error correction and feeds the data to output buffers. The set of output buffers are powered from a separate supply, allowing adjustment of the output voltage swing. There is no discernible difference in performance between the two channels.

### USING THE AD9288

Good high speed design practices must be followed when using the AD9288. To obtain maximum benefit, decoupling capacitors should be physically as close to the chip as possible, minimizing trace and via inductance between chip pins and capacitor (0603 surface mount caps are used on the AD9288/PCB evaluation board). It is recommended to place a 0.1  $\mu\text{F}$  capacitor at each power-ground pin pair for high frequency decoupling, and include one 10  $\mu\text{F}$  capacitor for local low frequency decoupling. The VREF IN pin should also be decoupled by a 0.1  $\mu\text{F}$  capacitor. It is also recommended to use a split power plane and contiguous ground plane (see evaluation board section). Data output traces should be short (<1 inch), minimizing on-chip noise at switching.

### ENCODE Input

Any high speed A/D converter is extremely sensitive to the quality of the sampling clock provided by the user. A track/hold circuit is essentially a mixer. Any noise, distortion or timing jitter on the clock will be combined with the desired signal at the A/D output. For that reason, considerable care has been taken in the design of the ENCODE input of the AD9288, and the user is advised to give commensurate thought to the clock source. The ENCODE input is fully TTL/CMOS compatible.

### Digital Outputs

The digital outputs are TTL/CMOS compatible for lower power consumption. During standby, the output buffers transition to a high impedance state. A data format selection option supports either twos complement (set high) or offset binary output (set low) formats.

### Analog Input

The analog input to the AD9288 is a differential buffer. For best dynamic performance, impedance at  $A_{\text{IN}}$  and  $\overline{A}_{\text{IN}}$  should match. Special care was taken in the design of the analog input stage of the AD9288 to prevent damage and corruption of data when the input is overdriven. The nominal input range is 1.024 V p-p centered at  $V_{\text{D}} \times 0.3$ .

### Voltage Reference

A stable and accurate 1.25 V voltage reference is built into the AD9288 ( $\text{REF}_{\text{OUT}}$ ). In normal operation, the internal reference is used by strapping Pins 5 ( $\text{REF}_{\text{INA}}$ ) and 7 ( $\text{REF}_{\text{INB}}$ ) to Pin 6 ( $\text{REF}_{\text{OUT}}$ ). The input range can be adjusted by varying the reference voltage applied to the AD9288. No appreciable degradation in performance occurs when the reference is adjusted  $\pm 5\%$ . The full-scale range of the ADC tracks reference voltage, which changes linearly.

### Timing

The AD9288 provides latched data outputs, with four pipeline delays. Data outputs are available one propagation delay ( $t_{\text{PD}}$ ) after the rising edge of the encode command (see Figures 1, 2 and 3). The length of the output data lines and loads placed on them should be minimized to reduce transients within the AD9288. These transients can detract from the converter's dynamic performance.

The minimum guaranteed conversion rate of the AD9288 is 1 MSPS. At clock rates below 1 MSPS, dynamic performance will degrade. Typical power-up recovery time after standby mode is 15 clock cycles.

### User Select Options

Two pins are available for a combination of operational modes. These options allow the user to place both channels in standby, excluding the reference, or just the B channel. Both modes place the output buffers and clock inputs in high impedance states.

The other option allows the user to skew the B channel output data by 1/2 a clock cycle. In other words, if two clocks are fed to the AD9288 and are 180° out of phase, enabling the data align will allow Channel B output data to be available at the rising edge of Clock A. If the same encode clock is provided to both channels and the data align pin is enabled, then output data from Channel B will be 180° out of phase with respect to Channel A. If the same encode clock is provided to both channels and the data align pin is disabled, then both outputs are delivered on the same rising edge of the clock.

### EVALUATION BOARD

The AD9288 evaluation board offers an easy way to test the AD9288. It provides a means to drive the analog inputs single-endedly or differentially. The two encode clocks are easily accessible at on-board SMB connectors J2, J7. These clocks are buffered on the board to provide the clocks for an on-board DAC and latches. The digital outputs and output clocks are available at a standard 37-pin connector, P2. The board has several different modes of operation, and is shipped in the following configuration:

- Single-Ended Analog Input
- Normal Operation Timing Mode
- Internal Voltage Reference

### Power Connector

Power is supplied to the board via a detachable 6-pin power strip, P1.

VREFA	– Optional External Reference Input	(1.25 V/1 $\mu\text{A}$ )
VREFB	– Optional External Reference Input	(1.25 V/1 $\mu\text{A}$ )
VDL	– Supply for Support Logic and DAC	(3 V/215 mA)
VDD	– Supply for ADC Outputs	(3 V/15 mA)
VD	– Supply for ADC Analog	(3 V/30 mA)

### Analog Inputs

The evaluation board accepts a 1 V analog input signal centered at ground at each analog input. These can be single-ended signals using SMB connectors J5 (channel A) and J1 (Channel B). In this mode use jumpers E4–E5 and E6–E7. (E1–E2 and E9–E10 jumpers should be lifted.)

Differential analog inputs use SMB connectors J4 and J6. Input is 1 V centered at ground. The single-ended input is converted

to differential by transformers T1, T2—allowing the ADC performance for differential inputs to be measured using a single-ended source. In this mode use jumpers E1–E2, E3–E4, E7–E8 and E9–E10. (E4–E5 and E6–E7 jumpers should be lifted.)

Each analog input is terminated on the board with  $50\ \Omega$  to ground. Each input is ac-coupled on the board through a  $0.1\ \mu\text{F}$  capacitor to an on-chip resistor divider that provides dc bias. Note that the inverting analog inputs are terminated on the board with  $25\ \Omega$  (optimized for single-ended operation). When driving the board differentially these resistors can be changed to  $50\ \Omega$  to provide balanced inputs.

#### Encode

The encode clock for channel A uses SMB connector J7. Channel B encode is at SMB connector J2. Each clock input is terminated on the board with  $50\ \Omega$  to ground. The input clocks are fed directly to the ADC and to buffers U5, U6 which drive the DAC and latches. The clock inputs are TTL compatible, but should be limited to a maximum of  $V_D$ .

#### Voltage Reference

The AD9288 has an internal  $1.25\ \text{V}$  voltage reference. An external reference for each channel may be employed instead. The evaluation board is configured for the internal reference (use jumpers E18–E41 and E17–E19. To use external references, connect to VREFA and VREFB pins on the power connector P1 and use jumpers E20–E18 and E21–E19.

#### Normal Operation Mode

In this mode both converters are clocked by the same encode clock; latency is four clock cycles (see timing diagram). Signal S1 (Pin 8) is held high and signal S2 (Pin 9) is held low. This is set at jumpers E22–E29 and E26–E23.

#### Data Align Mode

In this mode channel B output is delayed an additional  $1/2$  cycle. Signal S1 (Pin 8) and signal S2 (Pin 9) are both held high. This is set at jumpers E22–E29 and E26–E28.

#### Data Format Select

Data Format Select sets the output data format that the ADC outputs. Setting DFS (Pin 4) low at E30–E27 sets the output format to be offset binary; setting DFS high at E30–E25 sets the output to be twos complement.

#### Data Outputs

The ADC digital outputs are latched on the board by two 574s, the latch outputs are available at the 37-pin connector at Pins 22–29 (Channel A) and Pins 30–37 (Channel B). A latch output clock (data ready) is available at Pin 2 or 21 on the output connector. The data ready signal can be aligned with clock A input by connecting E31–E32 or aligned with clock B input by connecting E31–E33.

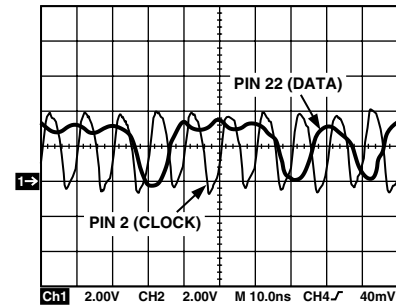

Figure 4. Data Output and Clock at 37-Pin Connector

#### DAC Outputs

Each channel is reconstructed by an on-board dual channel DAC, an AD9763. This DAC is intended to assist in debug—it should not be used to measure the performance of the ADC. It is a current output DAC with on-board  $50\ \Omega$  termination resistors. Figure 5 is representative of the DAC output with a full-scale analog input. The scope setting was low bandwidth,  $50\ \Omega$  termination. Note that both Encode A and Encode B need to be running to use the DAC.

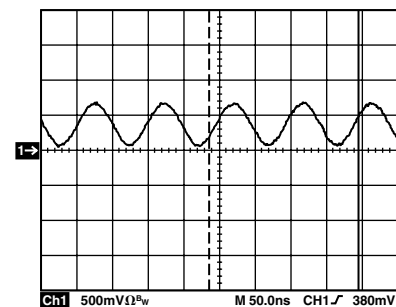

Figure 5. AD9763 Reconstruction DAC Output

#### Troubleshooting

If the board does not seem to be working correctly, try the following:

- Verify power at IC pins.
- Check that all jumpers are in the correct position for the desired mode of operation.
- Verify VREF is at  $1.25\ \text{V}$
- Try running encode clock and analog inputs at low speeds ( $10\ \text{MSPS}/1\ \text{MHz}$ ) and monitor 574 outputs, DAC outputs, and ADC outputs for toggling.

The AD9288 Evaluation Board is provided as a design example for customers of Analog Devices, Inc. ADI makes no warranties, express, statutory, or implied, regarding merchantability or fitness for a particular purpose.

# AD9288

## BILL OF MATERIALS

#	QTY	REFDES	DEVICE	PACKAGE	VALUE
1	22	C1-C15, C20-C25, C27	Ceramic Cap	0603	0.1 $\mu$ F
2	5	C16-C19, C26	Tantalum Cap	TAJD	10 $\mu$ F
3	43	E1-E43	W-HOLE	W-HOLE	
4	8	J1-J8	SMBPN	SMBP	
5	1	P1	TB6	TB6	
6	1	P2	37DRFP	C37DRFP	
7	10	R1, R3, R5-R7, R10-R14	Resistor	R1206	50 $\Omega$
8	2	R2, R4	Resistor	R1206	25 $\Omega$
9	2	R8, R9	Resistor	R1206	2 k $\Omega$
10	2	R15, R16	Resistor	R1206	0 $\Omega$
11	2	T1, T2	Transformer	T1-1T	
12	1	U1	AD9288BST-100	LQFP48	
13	1	U2	AD9763	LQFP48	
14	2	U3, U4	74ACQ574	DIP20\SOL	
15	2	U5, U6	SN74LCX86	SO14	

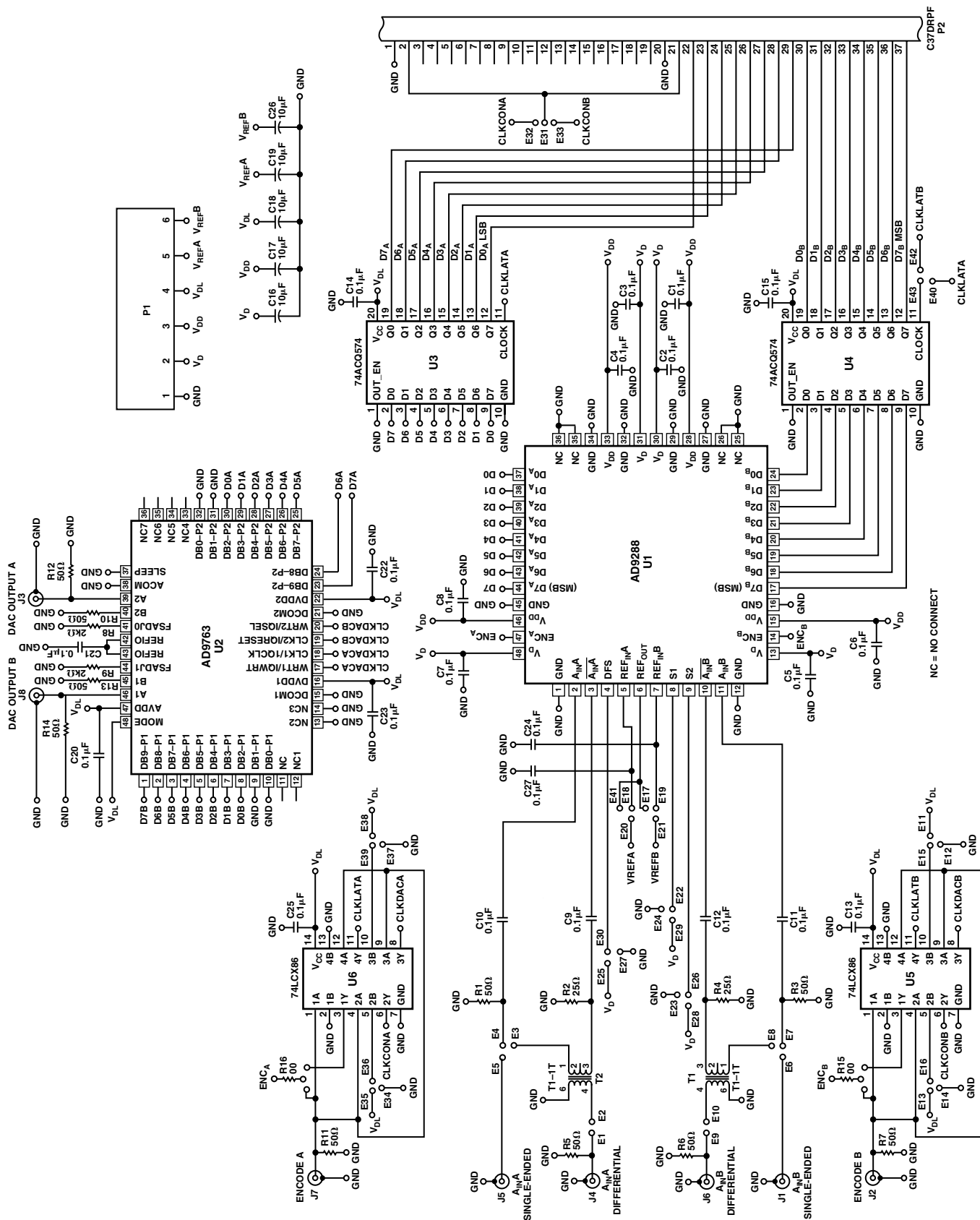

Figure 6. Dual Evaluation Board Schematic

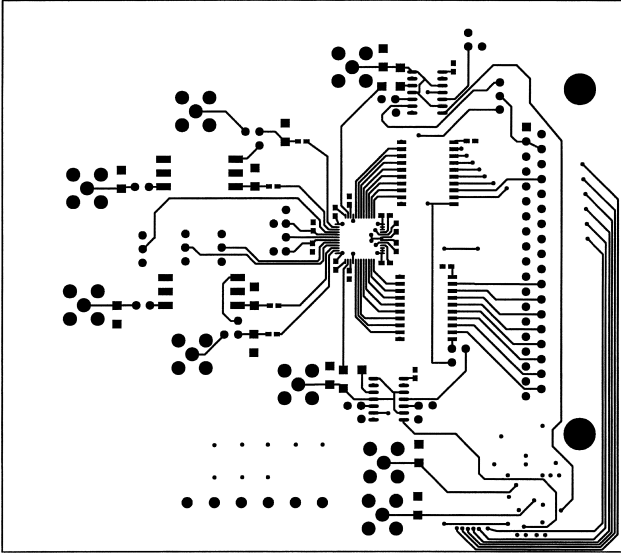

Figure 7. Printed Circuit Board Top Side Copper

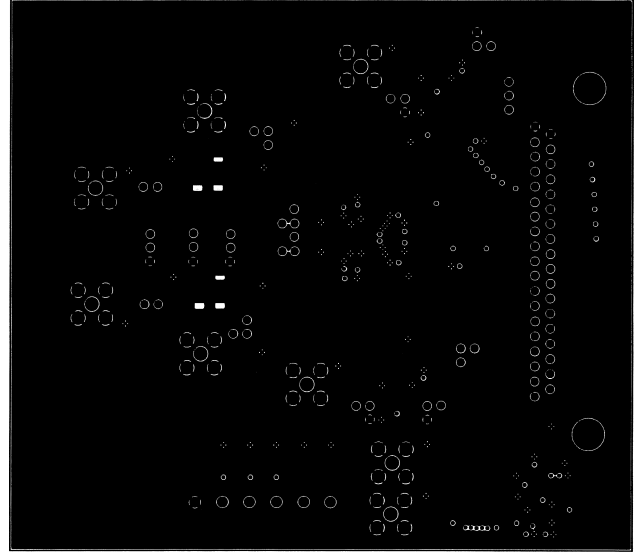

Figure 9. Printed Circuit Board Ground Layer

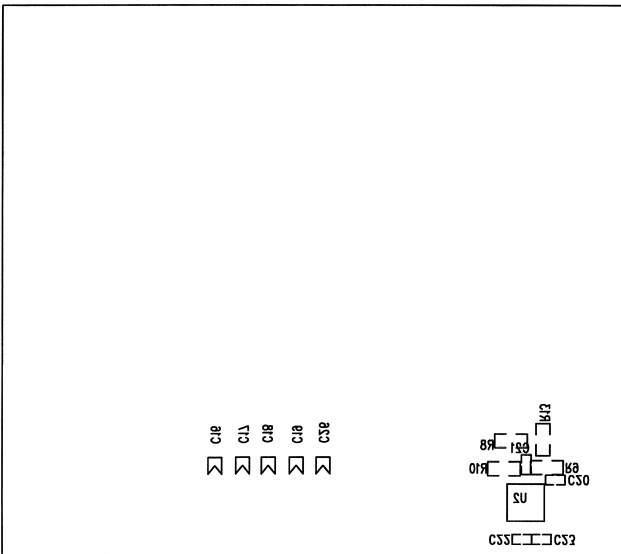

Figure 8. Printed Circuit Board Bottom Side Silkscreen

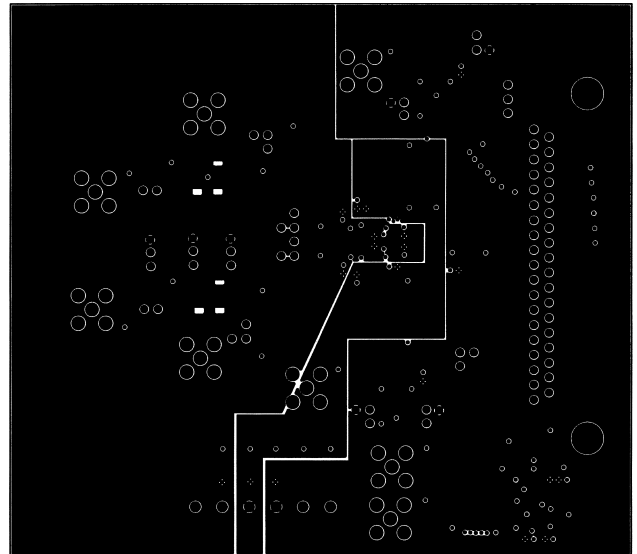

Figure 10. Printed Circuit Board "Split" Power Layer



