



## DM9300 / DM8300 (9300-51/9300-59) four-bit shift register

### general description

The DM9300/DM8300 is a four-bit multi-function shift register designed to work at typical speeds of 25 MHz.

It features a common asynchronous Reset input which resets the register independent of any other input. In addition, the J and  $\bar{K}$  inputs to the first flip flop enable greater flexibility in the operation of the register. (See truth table.)

The  $\bar{PE}$  (Parallel Enable) control allows information to be entered from the parallel inputs or be

shifted right. When the  $\bar{PE}$  input is in the logical "0" state, the information on the parallel inputs will be entered into the flip flops on the subsequent clock pulse. A logical "1" level on the PE control will allow shifting to the right.

The outputs change state on the positive-going transition of the clock input.

This register is completely compatible with Series 54/74 and CCSL devices. Input diode clamps are provided for additional system reliability.

### connection diagram

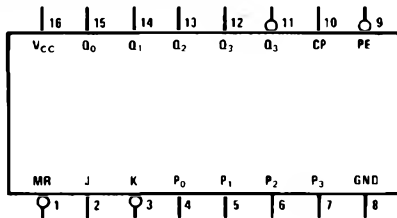

### truth table

J	$\bar{K}$	$Q_0$ at $t_{n+1}$
0	0	0
0	1	$Q_0$ at $t_n$ (no change)
1	0	$\bar{Q}_0$ at $t_n$ (toggle)
1	1	1

( $\bar{PE}$  = logical "1",  $\bar{MR}$  = logical "1")

### typical application

#### Eight Bit Left/Right Shift Register

This register shifts left or right on each shift clock, depending upon the condition of the LS/RS select input. If this input is high, right shift occurs and if low, left shift occurs.

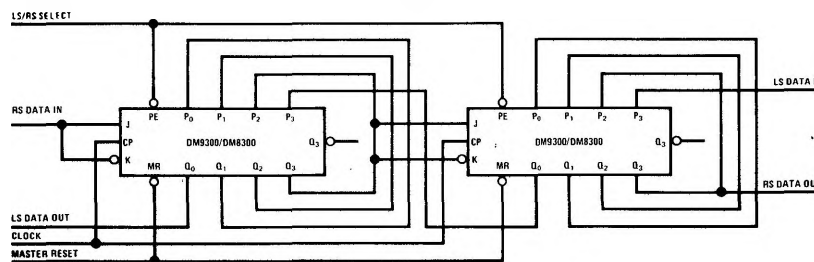

### equivalent circuits

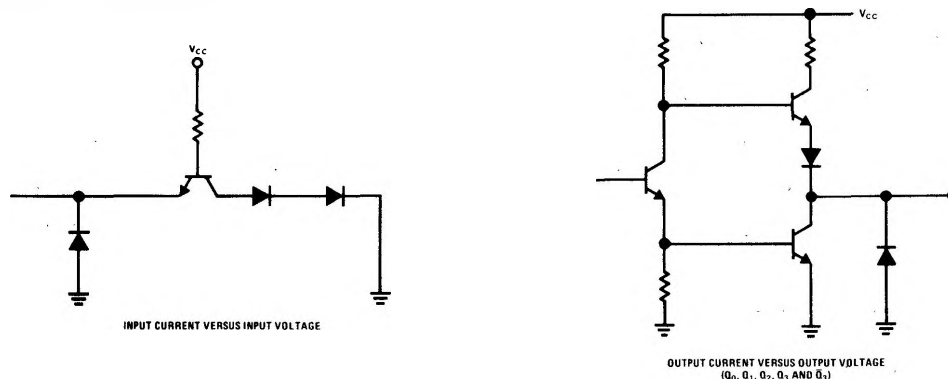

**absolute maximum ratings**

$V_{CC}$ Voltage Range	-5V to 7V
Input Voltage Range	-5V to 5.5V
Output Voltage (Logical "1" state)	5.5V
Operating Temperature Range	DM9300(9300-51) -55°C to +125°C
	DM8300(9300-59) 0°C to 75°C
Storage Temperature Range	-65°C to +150°C
Lead Temperature (Soldering, 10 sec)	300°C

**electrical characteristics** ( $T_A = -55^\circ\text{C}$  to  $+125^\circ\text{C}$ ,  $V_{CC} = 5.0\text{V} \pm 10\%$ )

SYMBOL	CHARACTERISTICS	LIMITS						UNITS	CONDITIONS & COMMENTS	
		-55°C		+25°C			+125°C			
		MIN	MAX	MIN	TYP	MAX	MIN			MAX
$V_{OH}$	Output High Voltage	2.4		2.4	2.7		2.4		Volts	$V_{CC} = 4.5\text{V}$ , $I_{OH} = -0.36\text{ mA}$
$V_{OL}$	Output Low Voltage		0.4		0.2	0.4		0.4	Volts	$V_{CC} = 5.5\text{V}$ , $I_{OL} = 9.6\text{ mA}$ $V_{CC} = 4.5\text{V}$ , $I_{OL} = 7.44\text{ mA}$
$V_H$	Input High Voltage	2.0		1.7			1.4		Volts	Guaranteed input high threshold for all inputs
$V_L$	Input Low Voltage		0.8			0.9		0.8	Volts	Guaranteed input low threshold for all inputs
$I_F$	Input Load Current	-1.6		-1.10	-1.6		-1.6		mA	$V_{CC} = 5.5\text{V}$
	J, K, MR, P <sub>0</sub> , P <sub>1</sub> , P <sub>2</sub> & P <sub>3</sub>	-1.24		-0.97	-1.24		-1.24		mA	$V_{CC} = 4.5\text{V}$ $V_F = 0.4\text{V}$
$I_R$	Input Leakage Current			15	60		60		μA	$V_{CC} = 5.5\text{V}$ , $V_R = 4.5\text{V}$
	J, K, MR, P <sub>0</sub> , P <sub>1</sub> , P <sub>2</sub> & P <sub>3</sub>									

**electrical characteristics** ( $T_A = 0^\circ\text{C}$  to  $+75^\circ\text{C}$ ,  $V_{CC} = 5.0\text{V} \pm 5\%$ )

SYMBOL	CHARACTERISTICS	LIMITS						UNITS	CONDITIONS & COMMENTS	
		0°C		+25°C			+75°C			
		MIN	MAX	MIN	TYP	MAX	MIN			MAX
$V_{OH}$	Output High Voltage	2.4		2.4	3.0		2.4		Volts	$V_{CC} = 4.75\text{V}$ , $I_{OH} = -0.36\text{ mA}$
$V_{OL}$	Output Low Voltage		0.45		0.2	0.45		0.45	Volts	$V_{CC} = 5.25\text{V}$ , $I_{OL} = 9.6\text{ mA}$
$V_H$	Input High Voltage	1.9		1.8			1.6		Volts	$V_{CC} = 4.75\text{V}$ , $I_{OL} = 8.5\text{ mA}$ Guaranteed input high threshold for all inputs
$V_L$	Input Low Voltage		0.85			0.85		0.85	Volts	Guaranteed input low threshold for all inputs
$I_F$	Input Load Current	-1.6		-1.0	-1.6		-1.6		mA	$V_{CC} = 5.25\text{V}$
	J, K, MR, P <sub>0</sub> , P <sub>1</sub> , P <sub>2</sub> & P <sub>3</sub>	-1.41		-0.9	-1.41		-1.41		mA	$V_{CC} = 4.75\text{V}$ , $V_F = 0.45\text{V}$
$I_R$	Input Leakage Current			15	60		60		μA	$V_{CC} = 5.25\text{V}$ , $V_R = 4.5\text{V}$
	J, K, MR, P <sub>0</sub> , P <sub>1</sub> , P <sub>2</sub> & P <sub>3</sub>									

**switching characteristics** ( $T_A = 25^\circ\text{C}$ )

SYMBOL	CHARACTERISTIC	MIN	TYP	MAX	UNITS	CONDITIONS & COMMENTS
$t_{pd+}$	Turn Off Delay		17	35	ns	$V_{CC} = 5.0\text{V}$ , $C_L = 15\text{ pF}$
$t_{pd-}$	Turn On Delay		22	45	ns	(See Figs. 1 & 2a)
$f_{sr}$	Shift Right Frequency	15	30		MHz	$V_{CC} = 5.0\text{V}$ , $C_L = 15\text{ pF}$ (See Figs. 1 & 2c)
$CP_{pw}$	Clock Pulse Width	35	15		ns	
$t_s$	Set-up Time	35	10		ns	$V_{CC} = 5.0\text{V}$
$t_r$	Release Time		10	0	ns	$C_L = 15\text{ pF}$
$t_s(\overline{PE})$	Set-up Time for $\overline{PE}$	45	20		ns	(See Figs. 2a & 2b)
$t_r(\overline{PE})$	Release Time for $\overline{PE}$		17	10	ns	
$t_{pd-}(\overline{MR})$	Reset Time for $\overline{MR}$		28		ns	
$t_{rec}(\overline{MR})$	Recovery Time for $\overline{MR}$		13		ns	
$MR_{pw}$	Min Reset Pulse Width		15		ns	

**SET UP TIME:**  $t_s$  is defined as the minimum time required for the logic level to be present at the logic input prior to the clock transition from low to high in order for the flip flop(s) to respond.

**RELEASE TIME:**  $t_r$  is defined as the maximum time allowed for the logic level to be present at the logic input prior to the clock transition from low to high in order for the flip flop(s) not to respond.

**RECOVERY TIME FOR  $\overline{MR}$ :**  $t_{rec}(\overline{MR})$  is defined as the minimum time required between the end of the reset pulse and the clock transition from low to high in order for the flip flop(s) to respond to the clock.

typical performance characteristics

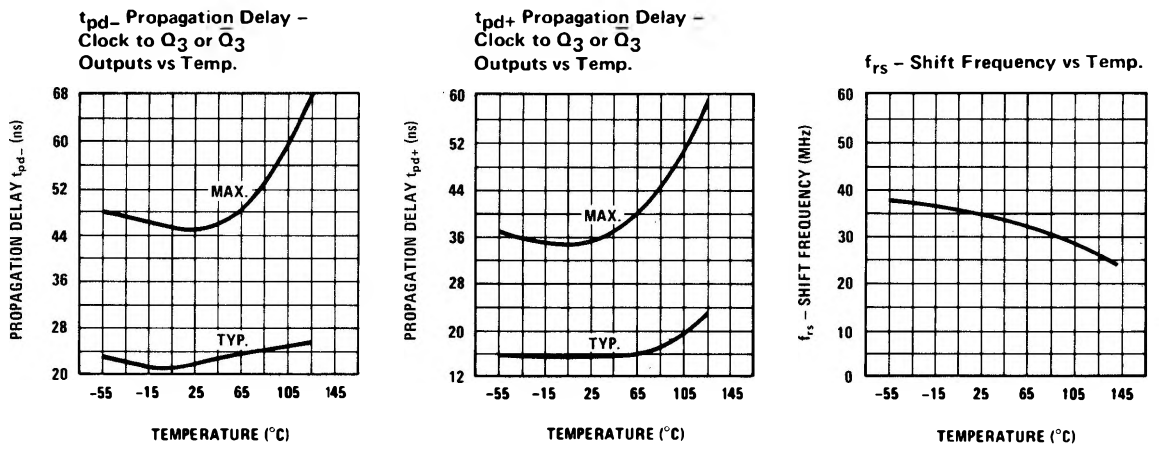
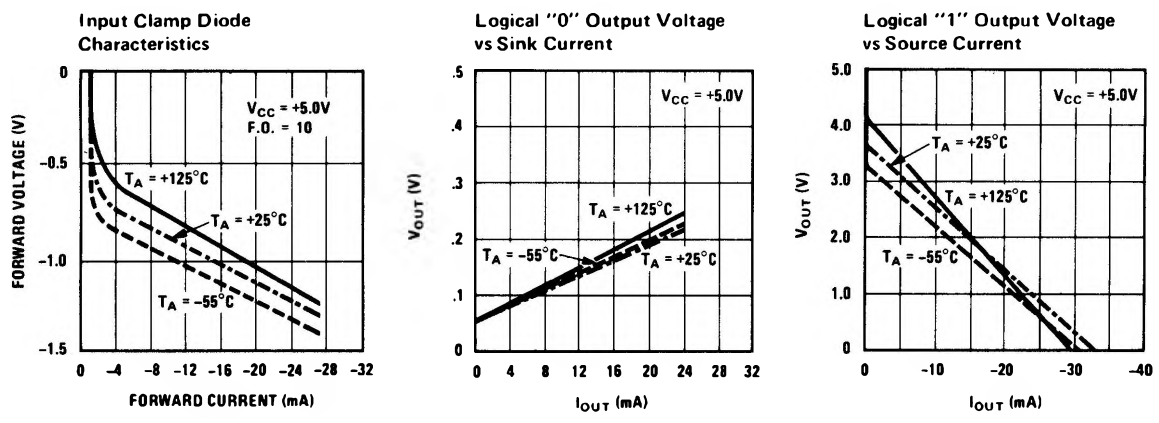

ac test circuit

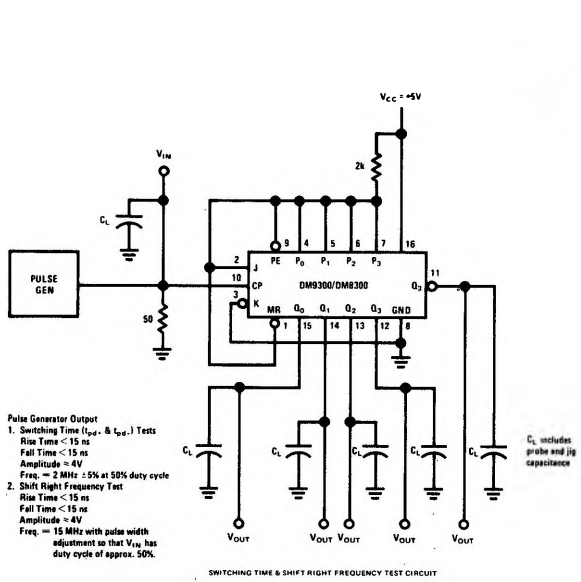

Figure 1

switching time waveforms

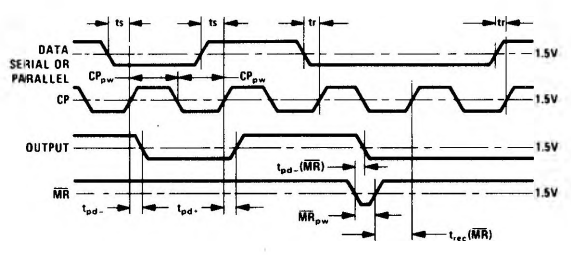

Figure 2a

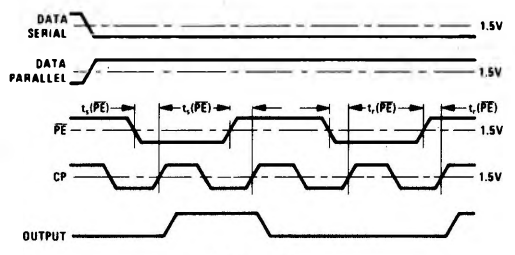

Figure 2b

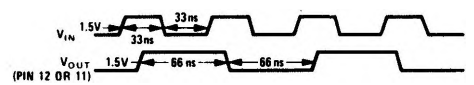

Figure 2c