

## 9005 • 9008 9006

### EXTENDABLE AND-OR-INVERT GATES EXTENDER (9006)

#### CONNECTION DIAGRAMS PINOUT A

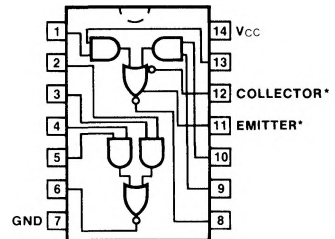

\*Four extenders (9006) may be tied to these terminals

Vcc = Pin 14  
GND = Pin 7

#### PINOUT B

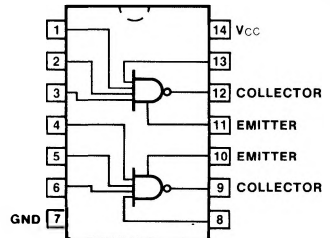

Vcc = Pin 14  
GND = Pin 7

#### PINOUT C

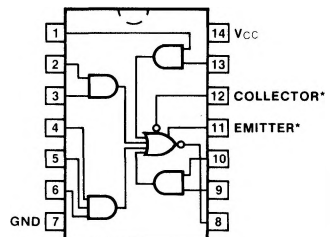

\*Four extender (9006) may be tied to these terminals

Vcc = Pin 14  
GND = Pin 7

**DESCRIPTION:** — The 9005 and 9008 are AND-OR-INVERT gates which may be OR extended with the use of the 9006.

**ORDERING CODE:** See Section 9

PKGS	PIN OUT	COMMERCIAL GRADE	MILITARY GRADE	PKG TYPE
		V <sub>CC</sub> = +5.0 V ±5%, T <sub>A</sub> = 0°C to +75°C	V <sub>CC</sub> = +5.0 V ±10%, T <sub>A</sub> = -55°C to +125°C	
Ceramic DIP (D)	A	9005DC	9005DM	6A
	B	9006DC	9006DM	
	C	9008DC	9008DM	
Flatpak (F)	A	9005FC	9005FM	3I
	B	9006FC	9006FM	
	C	9008FC	9008FM	

**INPUT LOADING/FAN-OUT:** See Section 3 for U.L. definitions

PINS	9005 (U.L.) HIGH/LOW	9006 (U.L.) HIGH/LOW	9008 (U.L.) HIGH/LOW
Non-extendable Gate Inputs	1.5/1.0		
Extendable Gate Inputs	2.25/1.5		
All Inputs		2.25/1.5	2.25/1.5
Outputs	30/8.8 (33)/(8.5)	*	30/8.8 (33)/(8.5)

\*Outputs on 9006 have open-emitter and collector

# 9XXX Series

## DC AND AC CHARACTERISTICS OVER COMMERCIAL TEMPERATURE RANGE: $V_{CC} = +5.0\text{ V} \pm 5\%$

SYMBOL	PARAMETER	0°C		25°C		75°C		UNITS	CONDITIONS		
		Min	Max	Min	Max	Min	Max				
$V_{IH}$	Input HIGH Voltage	1.9		1.8		1.6		V	Guaranteed Input HIGH Threshold Voltage		
$V_{IL}$	Input LOW Voltage	0.85		0.85		0.85		V	Guaranteed Input LOW Threshold Voltage		
$V_{OL}$	Output LOW Voltage	0.45		0.45		0.45		V	$V_{CC} = 5.25\text{ V}$ , $I_{OL} = 16\text{ mA}$ ,		
		0.45		0.45		0.45		V	$V_{CC} = 4.75\text{ V}$ , $I_{OL} = 14.1\text{ mA}$		
$I_{IL}$	Input LOW Current 9005 Non-Extendable Gate	-1.6		-1.6		-1.6		mA	$V_{IN} = .45\text{ V}$ 5.25 V on Other Inputs		
		-1.41		-1.41		-1.41					
	Input LOW Current Extendable Gates and Extender	-2.4		-2.4		-2.4		mA			
		-2.12		-2.12		-2.12					
$I_{CC}$	Power Supply Current, ON 9005 Non-Extendable Gate	7.7		7.7		7.7		mA	All Inputs Open		
	9005 Extendable Gate	13.6		13.6		13.6					
	9008	17.7		17.7		17.7					
	Power Supply Current, OFF 9005 Non-Extendable Gate	3.4		3.4		3.4				mA	All Inputs Except Extender Inputs Gnd
	9005 Extendable Gate	5.1		5.1		5.1					
	9008	10.2		10.2		10.2					
Extra Current Drain when one 9006 Extender is attached to a 9005 Gate ON	2.05		2.05		2.05		mA	All Inputs HIGH			
Extra Current Drain when one 9006 Extender is attached to a 9005 gate OFF	2.54		2.54		2.54		mA	All Inputs Gnd			

## DC AND AC CHARACTERISTICS OVER MILITARY TEMPERATURE RANGE: $V_{CC} = +5.0\text{ V} \pm 10\%$

SYMBOL	PARAMETER	-55°C		25°C		125°C		UNITS	CONDITIONS
		Min	Max	Min	Max	Min	Max		
$V_{IH}$	Input HIGH Voltage	2.0		1.7		1.4		V	Guaranteed Input HIGH Threshold Voltage
$V_{IL}$	Input LOW Voltage	0.8		0.9		0.8		V	Guaranteed Input LOW Threshold Voltage
$V_{OL}$	Output LOW Voltage	0.4		0.4		0.4		V	$V_{CC} = 5.5\text{ V}$ , $I_{OL} = 17.6\text{ mA}$
		0.4		0.4		0.4		V	$V_{CC} = 4.5\text{ V}$ , $I_{OL} = 13.6\text{ mA}$
$I_{IL}$	Input LOW Current 9005 Non-extendable Gate	-1.6		-1.6		-1.6		mA	$V_{IN} = .4\text{ V}$ 5.5 V on Other Inputs
		-1.24		-1.24		-1.24			
	Input LOW Current Extendable Gate and Extender	-2.4		-2.4		-2.4		mA	
		-1.86		-1.86		-1.86			

### NOTE:

Output characteristics above apply to a 9005 (both gates) or a 9008.

Input characteristics above apply to a 9005 (both gates) or a 9008 using either the internal gates or an external 9006 extender.

## DC AND AC CHARACTERISTICS OVER MILITARY TEMPERATURE RANGE: $V_{CC} = +5.0\text{ V} \pm 10\%$ (Cont'd)

SYMBOL	PARAMETER	-55°C		25°C		125°C		UNITS	CONDITIONS
		Min	Max	Min	Max	Min	Max		
$I_{CC}$	Power Supply Current, ON								
	9005 Non-extendable Gate		6.5		6.5		6.5	mA	All Inputs Open
	9005 Extendable Gate		11.3		11.3		11.3		
	9008		12.5		12.5		12.5		
	Power Supply Current, OFF								
	9005 Non-extendable Gate		3.1		3.1		3.1	mA	All Inputs Except Extender Inputs Gnd
9005 Extendable Gate		4.7		4.7		4.7			
9008		9.4		9.4		9.4			
$\Delta I_{CC}$	Extra Current Drain from one 9006 Extender Gate ON		1.61		1.61		1.61	mA	All Inputs HIGH
	Extra Current Drain from one 9006 Extender Gate OFF		2.35		2.35		2.35	mA	All Inputs Gnd 9006 Attached to a 9005

### NOTE:

Output characteristics apply to a 9005 (both gates) or a 9008.

Input characteristics apply to a 9005 (both gates) or a 9008 using either the internal gates or an external 9006 extender.

### SWITCHING CHARACTERISTICS ( $T_A = 25^\circ\text{C}$ )

SYMBOL	LIMITS		UNITS	TEST CONDITIONS
	Min	Max		
$t_{PLH}$	3.0	12	ns	$V_{CC} = 5.0\text{ V}$ , $C_L = 15\text{ pF}$ 9005 Non-extendable Gate Only, See Figure a
$t_{PHL}$	3.0	14		
$t_{PLH}$	3.0	15	ns	$V_{CC} = 5.0\text{ V}$ , $C_L = 15\text{ pF}$ , $C_N = 5.0\text{ pF}$ 9005 Extendable Gate and 9008, See Figure b
$t_{PHL}$	3.0	12		
$\Delta t_{PLH}$	-2.0	4.0	ns	9006 Only  The 9006 is tested by measuring its propagation time through the 9005. The delay readings shall not exceed the 9005 readings by the specified amount. See Figure c
$\Delta t_{PHL}$	-2.0	4.0		

### SWITCHING CHARACTERISTICS TEST CIRCUITS

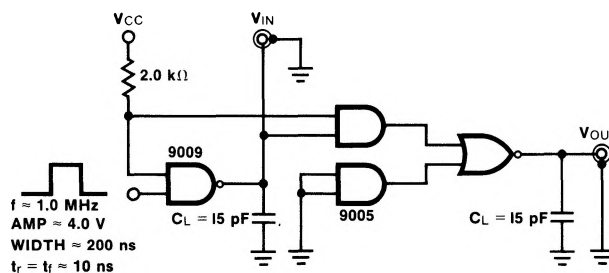

Note: Capacitance includes probe and jig capacitance

Fig. a 9005 Non-Extendable Gate

# 9XXX Series

## SWITCHING CHARACTERISTICS (Cont'd) TEST CIRCUITS

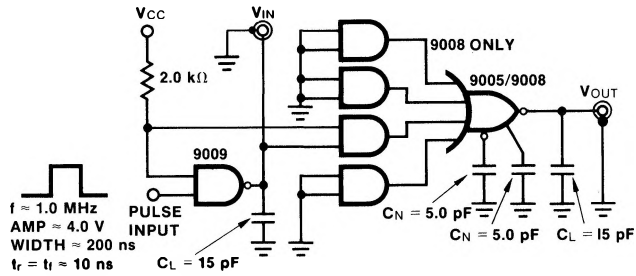

Note: Capacitance includes probe and jig capacitance

**Fig. b 9005 or 9008 Extensible Gate**

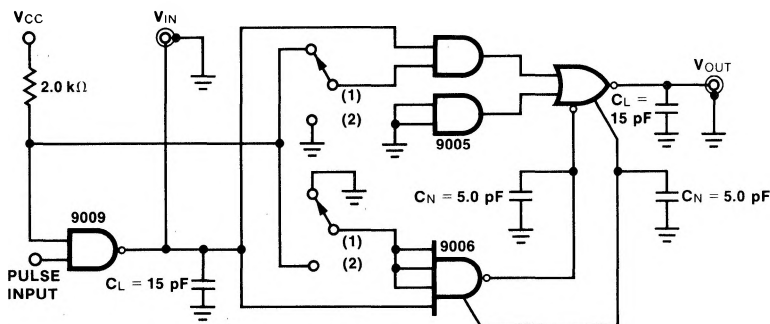

Note: Capacitance includes probe and jig capacitance

**Fig. c 9006 Extender**

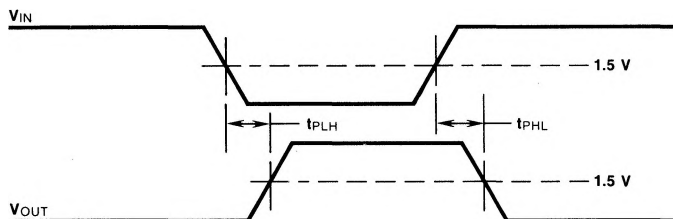

### NOTES:

With switch in position (1) measure delay of 9005. With switch in position (2) measure delay (9005) +  $\Delta$  delay (9006). Capacitances include probe and jig capacitances.

**Fig. d Switching Waveform**