

74LVT16373 • 74LVTH16373

Low Voltage 16-Bit Transparent Latch with 3-STATE Outputs

General Description

The LVT16373 and LVTH16373 contain sixteen non-inverting latches with 3-STATE outputs and is intended for bus oriented applications. The device is byte controlled. The flip-flops appear transparent to the data when the Latch Enable (LE) is HIGH. When LE is LOW, the data that meets the setup time is latched. Data appears on the bus when the Output Enable (\overline{OE}) is LOW. When \overline{OE} is HIGH, the outputs are in a high impedance state.

The LVTH16373 data inputs include bushold, eliminating the need for external pull-up resistors to hold unused inputs.

These latches are designed for low-voltage (3.3V) V_{CC} applications, but with the capability to provide a TTL interface to a 5V environment. The LVT16373 and LVTH16373 are fabricated with an advanced BiCMOS technology to

achieve high speed operation similar to 5V ABT while maintaining a low power dissipation.

Features

- Input and output interface capability to systems at 5V V_{CC}
- Bushold data inputs eliminate the need for external pull-up resistors to hold unused inputs (74LVTH16373), also available without bushold feature (74LVT16373).
- Live insertion/extraction permitted
- Power Up/Down high impedance provides glitch-free bus loading
- Outputs source/sink -32 mA/+64 mA
- Functionally compatible with the 74 series 16373
- Latch-up performance exceeds 500 mA

Ordering Code:

Order Number	Package Number	Package Description
74LVT16373MEA	MS48A	48-Lead Small Shrink Outline Package (SSOP), JEDEC MO-118, 0.300" Wide
74LVT16373MTD	MTD48	48-Lead Thin Shrink Small Outline Package (TSSOP), JEDEC MO-153, 6.1mm Wide
74LVTH16373MEA	MS48A	48-Lead Small Shrink Outline Package (SSOP), JEDEC MO-118, 0.300" Wide
74LVTH16373MTD	MTD48	48-Lead Thin Shrink Small Outline Package (TSSOP), JEDEC MO-153, 6.1mm Wide

Device also available in Tape and Reel. Specify by appending suffix letter "X" to the ordering code.

Logic Symbol

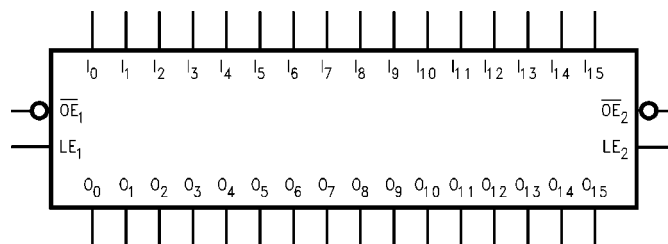

Connection Diagram

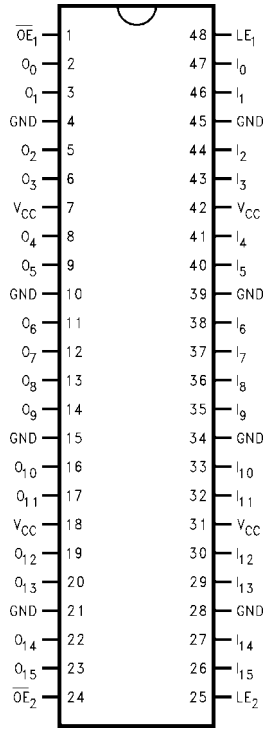

Pin Descriptions

Pin Names	Description
\overline{OE}_n	Output Enable Input (Active LOW)
LE_n	Latch Enable Input
I_0-I_{15}	Inputs
O_0-O_{15}	3-STATE Outputs

Truth Tables

Inputs			Outputs
LE_1	\overline{OE}_1	I_0-I_7	O_0-O_7
X	H	X	Z
H	L	L	L
H	L	H	H
L	L	X	O_0

Inputs			Outputs
LE_2	\overline{OE}_2	I_8-I_{15}	O_8-O_{15}
X	H	X	Z
H	L	L	L
H	L	H	H
L	L	X	O_0

H = HIGH Voltage Level
 L = LOW Voltage Level
 X = Immaterial
 Z = HIGH Impedance
 O_0 = Previous output prior to HIGH to LOW transition of LE

Functional Description

The LVT16373 and LVTH16373 contain sixteen D-type latches with 3-STATE standard outputs. The device is byte controlled with each byte functioning identically, but independent of the other. Control pins can be shorted together to obtain full 16-bit operation. The following description applies to each byte. When the Latch Enable (LE_n) input is HIGH, data on the D_n enters the latches. In this condition the latches are transparent, i.e., a latch output will change states each time its D input changes. When LE_n is LOW, the latches store information that was present on the D inputs a setup time preceding the HIGH-to-LOW transition of LE_n . The 3-STATE standard outputs are controlled by the Output Enable (\overline{OE}_n) input. When \overline{OE}_n is LOW, the standard outputs are in the 2-state mode. When \overline{OE}_n is HIGH, the standard outputs are in the high impedance mode but this does not interfere with entering new data into the latches.

Logic Diagrams

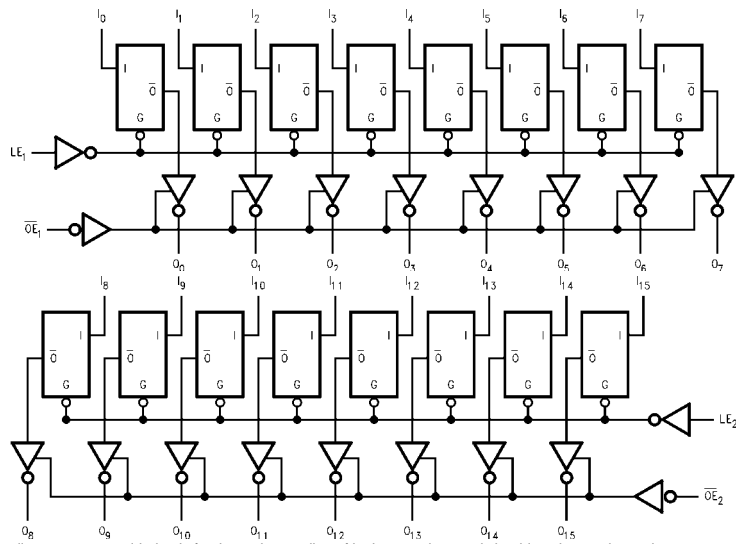

Please note that these diagrams are provided only for the understanding of logic operations and should not be used to estimate propagation delays.

Absolute Maximum Ratings (Note 1)				
Symbol	Parameter	Value	Conditions	Units
V_{CC}	Supply Voltage	-0.5 to +4.6		V
V_I	DC Input Voltage	-0.5 to +7.0		V
V_O	DC Output Voltage	-0.5 to +7.0	Output in 3-STATE	V
		-0.5 to +7.0	Output in HIGH or LOW State (Note 2)	
I_{IK}	DC Input Diode Current	-50	$V_I < \text{GND}$	mA
I_{OK}	DC Output Diode Current	-50	$V_O < \text{GND}$	mA
I_O	DC Output Current	64	$V_O > V_{CC}$ Output at HIGH State	mA
		128	$V_O > V_{CC}$ Output at LOW State	
I_{CC}	DC Supply Current per Supply Pin	± 64		mA
I_{GND}	DC Ground Current per Ground Pin	± 128		mA
T_{STG}	Storage Temperature	-65 to +150		$^{\circ}\text{C}$

Recommended Operating Conditions				
Symbol	Parameter	Min	Max	Units
V_{CC}	Supply Voltage	2.7	3.6	V
V_I	Input Voltage	0	5.5	V
I_{OH}	HIGH Level Output Current		-32	mA
I_{OL}	LOW Level Output Current		64	mA
T_A	Free-Air Operating Temperature	-40	85	$^{\circ}\text{C}$
$\Delta t/\Delta V$	Input Edge Rate, $V_{IN} = 0.8\text{V}-2.0\text{V}$, $V_{CC} = 3.0\text{V}$	0	10	ns/V

Note 1: Absolute Maximum continuous ratings are those values beyond which damage to the device may occur. Exposure to these conditions or conditions beyond those indicated may adversely affect device reliability. Functional operation under absolute maximum rated conditions is not implied.

Note 2: I_O Absolute Maximum Rating must be observed.

DC Electrical Characteristics

Symbol	Parameter	V_{CC} (V)	$T_A = -40^{\circ}\text{C}$ to $+85^{\circ}\text{C}$			Units	Conditions	
			Min	Typ (Note 3)	Max			
V_{IK}	Input Clamp Diode Voltage	2.7			-1.2	V	$I_I = -18\text{ mA}$	
V_{IH}	Input HIGH Voltage	2.7-3.6	2.0			V	$V_O \leq 0.1\text{V}$ or $V_O \geq V_{CC} - 0.1\text{V}$	
V_{IL}	Input LOW Voltage	2.7-3.6			0.8	V		
V_{OH}	Output HIGH Voltage	2.7-3.6	$V_{CC} - 0.2$			V	$I_{OH} = -100\ \mu\text{A}$	
		2.7	2.4				$I_{OH} = -8\text{ mA}$	
		3.0	2.0				$I_{OH} = -32\text{ mA}$	
V_{OL}	Output LOW Voltage	2.7			0.2	V	$I_{OL} = 100\ \mu\text{A}$	
		2.7			0.5		$I_{OL} = 24\text{ mA}$	
		3.0			0.4		$I_{OL} = 16\text{ mA}$	
		3.0			0.5		$I_{OL} = 32\text{ mA}$	
		3.0			0.55		$I_{OL} = 64\text{ mA}$	
$I_{I(HOLD)}$ (Note 4)	Bushold Input Minimum Drive	3.0	75			μA	$V_I = 0.8\text{V}$	
			-75				$V_I = 2.0\text{V}$	
$I_{I(OD)}$ (Note 4)	Bushold Input Over-Drive Current to Change State	3.0	500			μA	(Note 5)	
			-500				(Note 6)	
I_I	Input Current	3.6			10	μA	$V_I = 5.5\text{V}$	
			Control Pins	3.6		± 1	$V_I = 0\text{V}$ or V_{CC}	
			Data Pins	3.6		-5	$V_I = 0\text{V}$	
						1	$V_I = V_{CC}$	
I_{OFF}	Power Off Leakage Current	0			± 100	μA	$0\text{V} \leq V_I$ or $V_O \leq 5.5\text{V}$	
$I_{PU/PD}$	Power up/down 3-STATE	0-1.5V				± 100	μA	$V_O = 0.5\text{V}$ to 3.0V
	Output Current							$V_I = \text{GND}$ or V_{CC}
I_{OZL}	3-STATE Output Leakage Current	3.6			-5	μA	$V_O = 0.5\text{V}$	
I_{OZH}	3-STATE Output Leakage Current	3.6			5	μA	$V_O = 3.0\text{V}$	

DC Electrical Characteristics (Continued)

Symbol	Parameter	V _{CC} (V)	T _A = -40°C to +85°C			Units	Conditions
			Min	Typ (Note 3)	Max		
I _{OZH} ⁺	3-STATE Output Leakage Current	3.6			10	μA	V _{CC} < V _O ≤ 5.5V
I _{CCH}	Power Supply Current	3.6			0.19	mA	Outputs HIGH
I _{CCL}	Power Supply Current	3.6			5	mA	Outputs LOW
I _{CCZ}	Power Supply Current	3.6			0.19	mA	Outputs Disabled
I _{CCZ} ⁺	Power Supply Current	3.6			0.19	mA	V _{CC} ≤ V _O ≤ 5.5V, Outputs Disabled
ΔI _{CC}	Increase in Power Supply Current (Note 7)	3.6			0.2	mA	One Input at V _{CC} - 0.6V Other Inputs at V _{CC} or GND

Note 3: All typical values are at V_{CC} = 3.3V, T_A = 25°C.

Note 4: Applies to bushold versions only (74LVTH16373).

Note 5: An external driver must source at least the specified current to switch from LOW to HIGH.

Note 6: An external driver must sink at least the specified current to switch from HIGH to LOW.

Note 7: This is the increase in supply current for each input that is at the specified voltage level rather than V_{CC} or GND.

Dynamic Switching Characteristics (Note 8)

Symbol	Parameter	V _{CC} (V)	T _A = 25°C			Units	Conditions C _L = 50 pF, R _L = 500Ω
			Min	Typ	Max		
V _{OLP}	Quiet Output Maximum Dynamic V _{OL}	3.3		0.8		V	(Note 9)
V _{OLV}	Quiet Output Minimum Dynamic V _{OL}	3.3		-0.8		V	(Note 9)

Note 8: Characterized in SSOP package. Guaranteed parameter, but not tested.

Note 9: Max number of outputs defined as (n). n-1 data inputs are driven 0V to 3V. Output under test held LOW.

AC Electrical Characteristics

Symbol	Parameter	T _A = -40°C to +85°C, C _L = 50pF, R _L = 500Ω					Units
		V _{CC} = 3.3V ±0.3V			V _{CC} = 2.7V		
		Min	Typ (Note 10)	Max	Min	Max	
t _{PHL}	Propagation Delay	1.5		3.9	1.5	4.3	ns
t _{PLH}	D _n to O _n	1.5		3.8	1.5	4.2	
t _{PHL}	Propagation Delay	1.9		4.2	1.9	4.4	ns
t _{PLH}	LE to O _n	1.6		4.3	1.6	4.8	
t _{PZL}	Output Enable Time	1.3		4.3	1.3	4.9	ns
t _{PZH}		1.0		4.3	1.0	5.1	
t _{PLZ}	Output Disable Time	1.5		4.7	1.5	4.8	ns
t _{PHZ}		2.0		5.0	2.0	5.4	
t _S	Setup Time, D _n to LE	1.0			0.8		ns
t _H	Hold Time, D _n to LE	1.0			1.1		ns
t _W	LE Pulse Width	3.0			3.0		ns
t _{OSSL}	Output to Output Skew (Note 11)			1.0		1.0	ns
t _{OSLH}				1.0		1.0	

Note 10: All typical values are at V_{CC} = 3.3V, T_A = 25°C.

Note 11: Skew is defined as the absolute value of the difference between the actual propagation delay for any two separate outputs of the same device. The specification applies to any outputs switching in the same direction, either HIGH to LOW (t_{OSSL}) or LOW to HIGH (t_{OSLH}).

Capacitance (Note 12)

Symbol	Parameter	Conditions	Typical	Units
C _{IN}	Input Capacitance	V _{CC} = Open, V _I = 0V or V _{CC}	4	pF
C _{OUT}	Output Capacitance	V _{CC} = 3.0V, V _O = 0V or V _{CC}	8	pF

Note 12: Capacitance is measured at frequency f = 1 MHz, per MIL-STD-883, Method 3012.

Physical Dimensions inches (millimeters) unless otherwise noted

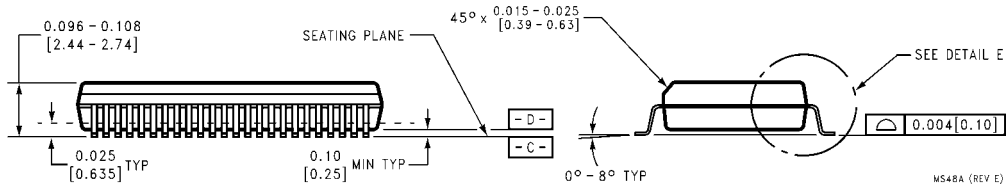
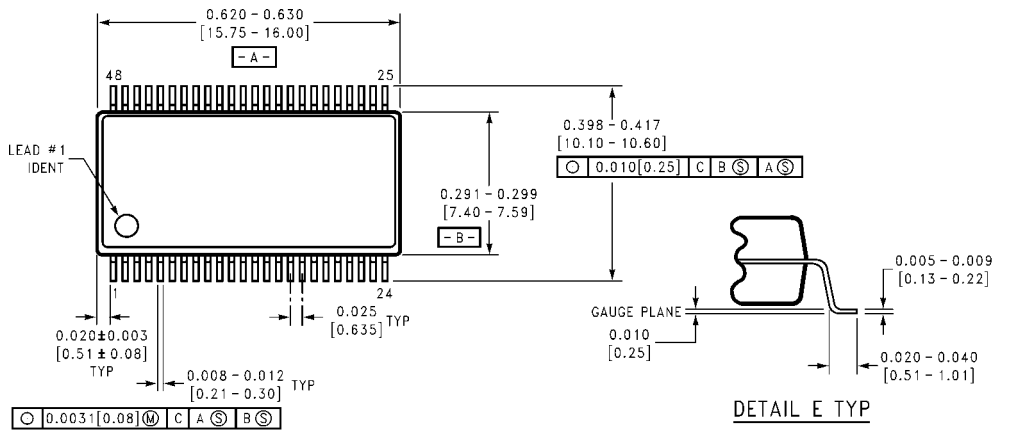

48-Lead Small Shrink Outline Package (SSOP), JEDEC MO-118, 0.300" Wide
Package Number MS48A

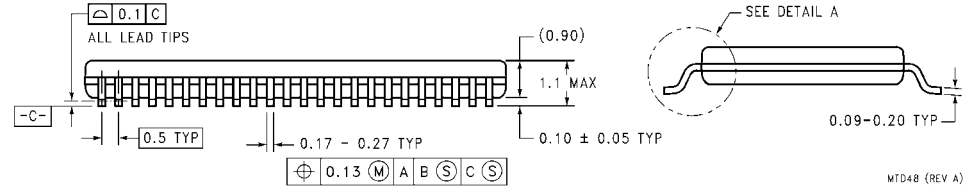
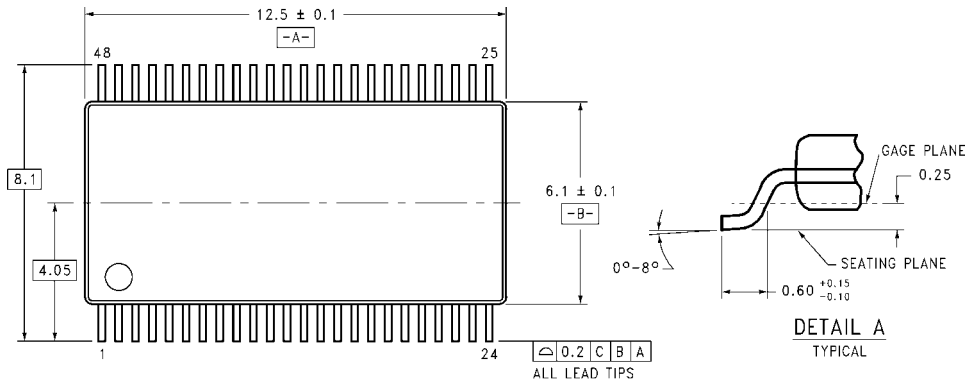

48-Lead Thin Shrink Small Outline Package (TSSOP), JEDEC MO-153, 6.1mm Wide
Package Number MTD48

LIFE SUPPORT POLICY

FAIRCHILD'S PRODUCTS ARE NOT AUTHORIZED FOR USE AS CRITICAL COMPONENTS IN LIFE SUPPORT DEVICES OR SYSTEMS WITHOUT THE EXPRESS WRITTEN APPROVAL OF THE PRESIDENT OF FAIRCHILD SEMICONDUCTOR CORPORATION. As used herein:

1. Life support devices or systems are devices or systems which, (a) are intended for surgical implant into the body, or (b) support or sustain life, and (c) whose failure to perform when properly used in accordance with instructions for use provided in the labeling, can be reasonably expected to result in a significant injury to the user.
2. A critical component in any component of a life support device or system whose failure to perform can be reasonably expected to cause the failure of the life support device or system, or to affect its safety or effectiveness.

www.fairchildsemi.com