

54AC153,54ACT153

54AC153 54ACT153 Dual 4-Input Multiplexer



Literature Number: SNOS088

54AC153 • 54ACT153 Dual 4-Input Multiplexer

General Description

The 'AC/ACT153 is a high-speed dual 4-input multiplexer with common select inputs and individual enable inputs for each section. It can select two lines of data from four sources. The two buffered outputs present data in the true (non-inverted) form. In addition to multiplexer operation, the 'AC/ACT153 can act as a function generator and generate any two functions of three variables.

Features

- I_{CC} reduced by 50%
- Outputs source/sink 24 mA
- 'ACT153 has TTL-compatible inputs
- Standard Microcircuit Drawings (SMD)
 - 'AC153: 5962-87625
 - 'ACT153: 5962-87698

Logic Symbols

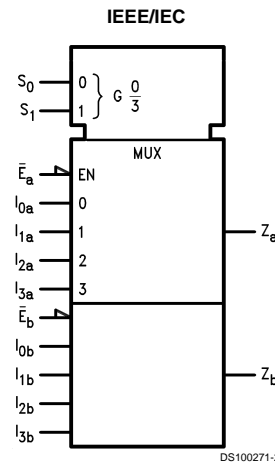
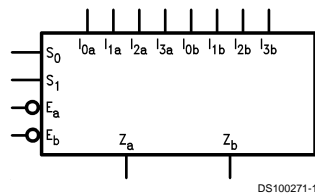

Pin Names	Description
I_{0a} – I_{3a}	Side A Data Inputs
I_{0b} – I_{3b}	Side B Data Inputs
S_0, S_1	Common Select Inputs
\bar{E}_a	Side A Enable Input
\bar{E}_b	Side B Enable Input
Z_a	Side A Output
Z_b	Side B Output

FACT® is a registered trademark of Fairchild Semiconductor Corporation.

Connection Diagrams

Pin Assignment
for DIP and Flatpak

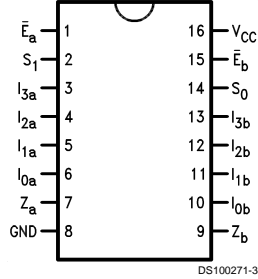

Pin Assignment
for LCC

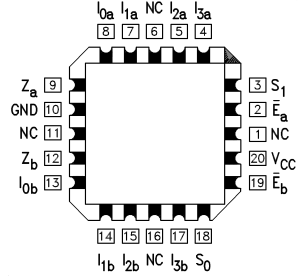

Functional Description

The 'AC/ACT153 is a dual 4-input multiplexer. It can select two bits of data from up to four sources under the control of the common Select inputs (S_0 , S_1). The two 4-input multiplexer circuits have individual active-LOW Enables (\bar{E}_a , \bar{E}_b) which can be used to strobe the outputs independently. When the Enables (\bar{E}_a , \bar{E}_b) are HIGH, the corresponding outputs Z_a , Z_b) are forced LOW. The 'AC/ACT153 is the logic implementation of a 2-pole, 4-position switch, where the position of the switch is determined by the logic levels supplied to the Select inputs. The logic equations for the outputs are shown below.

$$Z_a = \bar{E}_a \cdot (I_{0a} \cdot \bar{S}_1 \cdot \bar{S}_0 + I_{1a} \cdot \bar{S}_1 \cdot S_0 + I_{2a} \cdot S_1 \cdot \bar{S}_0 + I_{3a} \cdot S_1 \cdot S_0)$$

$$Z_b = \bar{E}_b \cdot (I_{0b} \cdot \bar{S}_1 \cdot \bar{S}_0 + I_{1b} \cdot \bar{S}_1 \cdot S_0 + I_{2b} \cdot S_1 \cdot \bar{S}_0 + I_{3b} \cdot S_1 \cdot S_0)$$

Truth Table

Select Inputs		Inputs (a or b)					Output
S_0	S_1	\bar{E}	I_0	I_1	I_2	I_3	Z
X	X	H	X	X	X	X	L
L	L	L	L	X	X	X	L
L	L	L	H	X	X	X	H
H	L	L	X	L	X	X	L
H	L	L	X	H	X	X	H
L	H	L	X	X	L	X	L
L	H	L	X	X	H	X	H
H	H	L	X	X	X	L	L
H	H	L	X	X	X	H	H

H = HIGH Voltage Level
L = LOW Voltage Level
X = Immaterial

Logic Diagram

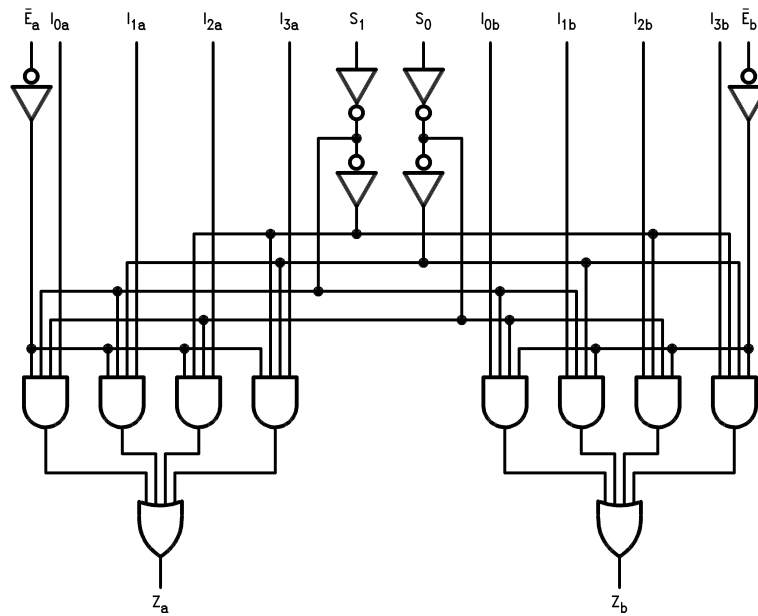

DS100271-5

Please note that this diagram is provided only for the understanding of logic operations and should not be used to estimate propagation delays.

Absolute Maximum Ratings (Note 1)

If Military/Aerospace specified devices are required, please contact the National Semiconductor Sales Office/Distributors for availability and specifications.

Supply Voltage (V_{CC})	-0.5V to +7.0V
DC Input Diode Current (I_{IK})	
$V_I = -0.5V$	-20 mA
$V_I = V_{CC} + 0.5V$	+20 mA
DC Input Voltage (V_I)	-0.5V to $V_{CC} + 0.5V$
DC Output Diode Current (I_{OK})	
$V_O = -0.5V$	-20 mA
$V_O = V_{CC} + 0.5V$	+20 mA
DC Output Voltage (V_O)	-0.5V to $V_{CC} + 0.5V$
DC Output Source or Sink Current (I_O)	±50 mA
DC V_{CC} or Ground Current per Output Pin (I_{CC} or I_{GND})	±50 mA
Storage Temperature (T_{STG})	-65°C to +150°C
Junction Temperature (T_J)	
CDIP	175°C

Recommended Operating Conditions

Supply Voltage (V_{CC})	
'AC	2.0V to 6.0V
'ACT	4.5V to 5.5V
Input Voltage (V_I)	0V to V_{CC}
Output Voltage (V_O)	0V to V_{CC}
Operating Temperature (T_A)	
54AC/ACT	-55°C to +125°C
Minimum Input Edge Rate ($\Delta V/\Delta t$)	
'AC Devices	
V_{IN} from 30% to 70% of V_{CC}	
V_{CC} @ 3.3V, 4.5V, 5.5V	125 mV/ns
Minimum Input Edge Rate ($\Delta V/\Delta t$)	
'ACT Devices	
V_{IN} from 0.8V to 2.0V	
V_{CC} @ 4.5V, 5.5V	125 mV/ns

Note 1: Absolute maximum ratings are those values beyond which damage to the device may occur. The databook specifications should be met, without exception, to ensure that the system design is reliable over its power supply, temperature, and output/input loading variables. National does not recommend operation of FACT® circuits outside databook specifications.

DC Characteristics for 'AC Family Devices

Symbol	Parameter	V_{CC} (V)	54AC	Units	Conditions	
			$T_A =$ -55°C to +125°C			
			Guaranteed Limits			
V_{IH}	Minimum High Level Input Voltage	3.0	2.1	V	$V_{OUT} = 0.1V$ or $V_{CC} - 0.1V$	
		4.5	3.15			
		5.5	3.85			
V_{IL}	Maximum Low Level Input Voltage	3.0	0.9	V	$V_{OUT} = 0.1V$ or $V_{CC} - 0.1V$	
		4.5	1.35			
		5.5	1.65			
V_{OH}	Minimum High Level Output Voltage	3.0	2.9	V	$I_{OUT} = -50 \mu A$	
		4.5	4.4			
		5.5	5.4			
			3.0	2.4	V	(Note 2) $V_{IN} = V_{IL}$ or V_{IH} $I_{OH} = -12 \text{ mA}$ $I_{OH} = -24 \text{ mA}$ $I_{OH} = -24 \text{ mA}$
			4.5	3.7		
			5.5	4.7		
V_{OL}	Maximum Low Level Output Voltage	3.0	0.1	V	$I_{OUT} = 50 \mu A$	
		4.5	0.1			
		5.5	0.1			
			3.0	0.50	V	(Note 2) $V_{IN} = V_{IL}$ or V_{IH} $I_{OL} = 12 \text{ mA}$ $I_{OL} = 24 \text{ mA}$ $I_{OL} = 24 \text{ mA}$
			4.5	0.50		
			5.5	0.50		
I_{IN}	Maximum Input Leakage Current	5.5	±1.0	µA	$V_I = V_{CC}, GND$	
I_{OLD}	Minimum Dynamic Output Current (Note 3)	5.5	50	mA	$V_{OLD} = 1.65V \text{ Max}$	
I_{OHD}		5.5	-50	mA	$V_{OHD} = 3.85V \text{ Min}$	

DC Characteristics for 'AC Family Devices (Continued)

Symbol	Parameter	V _{CC} (V)	54AC	Units	Conditions
			T _A = -55°C to +125°C		
			Guaranteed Limits		
I _{CC}	Maximum Quiescent Supply Current	5.5	80.0	μA	V _{IN} = V _{CC} or GND

Note 2: All outputs loaded; thresholds on input associated with output under test.

Note 3: Maximum test duration 2.0 ms, one output loaded at a time.

Note 4: I_{IN} and I_{CC} @ 3.0V are guaranteed to be less than or equal to the respective limit @ 5.5V V_{CC}.

I_{CC} for 54AC @ 25°C is identical to 74AC @ 25°C.

DC Characteristics for 'ACT Family Devices

Symbol	Parameter	V _{CC} (V)	54ACT	Units	Conditions
			T _A = -55°C to +125°C		
			Guaranteed Limits		
V _{IH}	Minimum High Level Input Voltage	4.5	2.0	V	V _{OUT} = 0.1V or V _{CC} - 0.1V
		5.5	2.0		
V _{IL}	Maximum Low Level Input Voltage	4.5	0.8	V	V _{OUT} = 0.1V or V _{CC} - 0.1V
		5.5	0.8		
V _{OH}	Minimum High Level Output Voltage	4.5	4.4	V	I _{OUT} = -50 μA
		5.5	5.4		
		4.5	3.70	V	(Note 5) V _{IN} = V _{IL} or V _{IH} I _{OH} = -24 mA I _{OH} = -24 mA
		5.5	4.70		
V _{OL}	Maximum Low Level Output Voltage	4.5	0.1	V	I _{OUT} = 50 μA
		5.5	0.1		
		4.5	0.50	V	(Note 5) V _{IN} = V _{IL} or V _{IH} I _{OL} = 24 mA I _{OL} = 24 mA
		5.5	0.50		
I _{IN}	Maximum Input Leakage Current	5.5	±1.0	μA	V _I = V _{CC} , GND
I _{CCT}	Maximum I _{CC} /Input	5.5	1.6	mA	V _I = V _{CC} - 2.1V
I _{OLD}	Minimum Dynamic Output Current (Note 6)	5.5	50	mA	V _{OLD} = 1.65V Max
I _{OHD}		5.5	-50	mA	V _{OHD} = 3.85V Min
I _{CC}	Maximum Quiescent Supply Current	5.5	80.0	μA	V _{IN} = V _{CC} or GND

Note 5: All outputs loaded; thresholds on input associated with output under test.

Note 6: Maximum test duration 2.0 ms, one output loaded at a time.

Note 7: I_{CC} for 54ACT @ 25°C is identical to 74ACT @ 25°C.

AC Electrical Characteristics

Symbol	Parameter	V _{CC} (V) (Note 8)	54AC		Units
			T _A = -55°C to +125°C C _L = 50 pF		
			Min	Max	
t _{PLH}	Propagation Delay S _n to Z _n	3.3	1.0	19.5	ns
		5.0	1.0	14.0	
t _{PHL}	Propagation Delay S _n to Z _n	3.3	1.0	18.0	ns
		5.0	1.0	13.5	
t _{PLH}	Propagation Delay Ē to Z _n	3.3	1.0	16.5	ns
		5.0	1.0	12.5	
t _{PHL}	Propagation Delay Ē to Z _n	3.3	1.0	14.0	ns
		5.0	1.0	10.0	
t _{PLH}	Propagation Delay I _n to Z _n	3.3	1.0	16.0	ns
		5.0	1.0	11.5	
t _{PHL}	Propagation Delay I _n to Z _n	3.3	1.0	14.5	ns
		5.0	1.0	10.5	

Note 8: Voltage Range 3.3 is 3.3V ±0.3V
Voltage Range 5.0 is 5.0V ±0.5V

AC Electrical Characteristics

Symbol	Parameter	V _{CC} (V) (Note 9)	54ACT		Units
			T _A = -55°C to +125°C C _L = 50 pF		
			Min	Max	
t _{PLH}	Propagation Delay S _n to Z _n	5.0	1.0	15.0	ns
t _{PHL}	Propagation Delay S _n to Z _n	5.0	1.0	14.5	ns
t _{PLH}	Propagation Delay Ē _n to Z _n	5.0	1.0	13.5	ns
t _{PHL}	Propagation Delay Ē _n to Z _n	5.0	1.0	11.5	ns
t _{PLH}	Propagation Delay I _n to Z _n	5.0	1.0	12.5	ns
t _{PHL}	Propagation Delay I _n to Z _n	5.0	1.0	12.0	ns

Note 9: Voltage Range 5.0 is 5.0V ±0.5V

Capacitance

Symbol	Parameter	Typ	Units	Conditions
C _{IN}	Input Capacitance	4.5	pF	V _{CC} = OPEN
C _{PD}	Power Dissipation Capacitance	65.0	pF	V _{CC} = 5.0V

Physical Dimensions inches (millimeters) unless otherwise noted

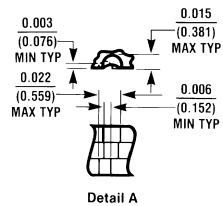
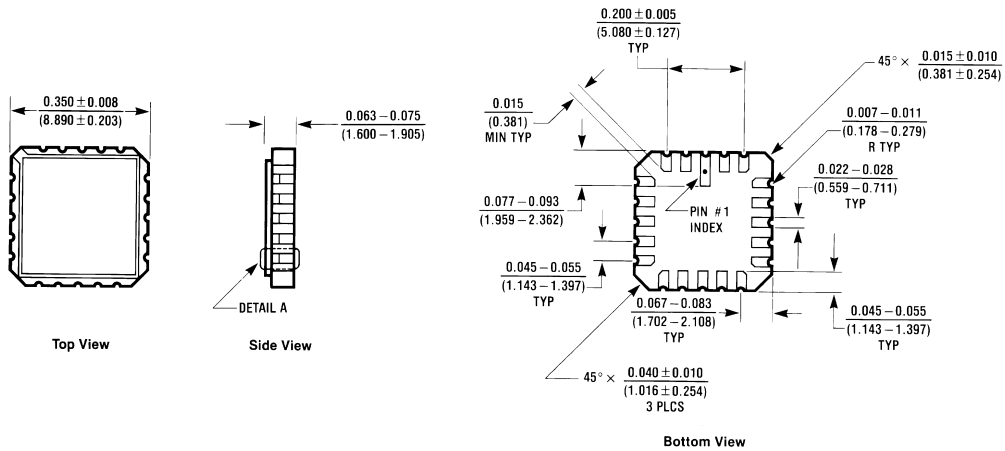

20 Terminal Ceramic Leadless Chip Carrier (L)
 NS Package Number E20A

E20A (REV D)

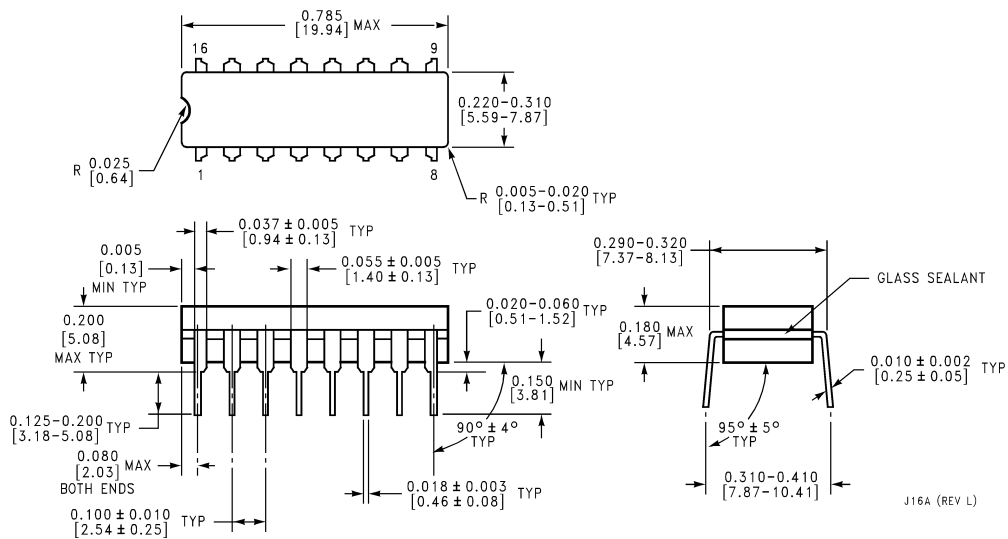

16-Lead Ceramic Dual-In-Line Package (D)
 NS Package Number J16A

J16A (REV L)

Physical Dimensions inches (millimeters) unless otherwise noted (Continued)

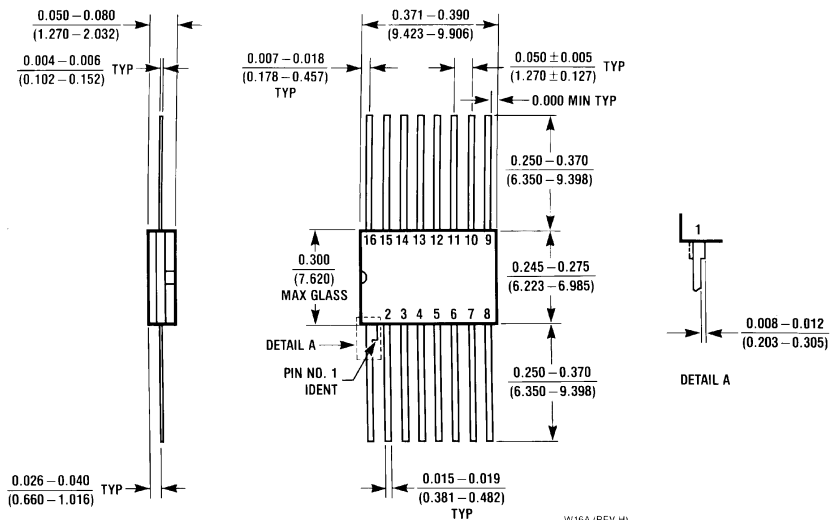

**16-Lead Ceramic Flatpak (F)
NS Package Number W16A**

LIFE SUPPORT POLICY

NATIONAL'S PRODUCTS ARE NOT AUTHORIZED FOR USE AS CRITICAL COMPONENTS IN LIFE SUPPORT DEVICES OR SYSTEMS WITHOUT THE EXPRESS WRITTEN APPROVAL OF THE PRESIDENT OF NATIONAL SEMICONDUCTOR CORPORATION. As used herein:

1. Life support devices or systems are devices or systems which, (a) are intended for surgical implant into the body, or (b) support or sustain life, and whose failure to perform when properly used in accordance with instructions for use provided in the labeling, can be reasonably expected to result in a significant injury to the user.
2. A critical component in any component of a life support device or system whose failure to perform can be reasonably expected to cause the failure of the life support device or system, or to affect its safety or effectiveness.



National Semiconductor Corporation
Americas
Tel: 1-800-272-9959
Fax: 1-800-737-7018
Email: support@nsc.com

National Semiconductor Europe
Fax: +49 (0) 1 80-530 85 86
Email: europe.support@nsc.com
Deutsch Tel: +49 (0) 1 80-530 85 85
English Tel: +49 (0) 1 80-532 78 32
Français Tel: +49 (0) 1 80-532 93 58
Italiano Tel: +49 (0) 1 80-534 16 80

National Semiconductor Asia Pacific Customer Response Group
Tel: 65-2544466
Fax: 65-2504466
Email: sea.support@nsc.com

National Semiconductor Japan Ltd.
Tel: 81-3-5620-6175
Fax: 81-3-5620-6179

www.national.com

IMPORTANT NOTICE

Texas Instruments Incorporated and its subsidiaries (TI) reserve the right to make corrections, modifications, enhancements, improvements, and other changes to its products and services at any time and to discontinue any product or service without notice. Customers should obtain the latest relevant information before placing orders and should verify that such information is current and complete. All products are sold subject to TI's terms and conditions of sale supplied at the time of order acknowledgment.

TI warrants performance of its hardware products to the specifications applicable at the time of sale in accordance with TI's standard warranty. Testing and other quality control techniques are used to the extent TI deems necessary to support this warranty. Except where mandated by government requirements, testing of all parameters of each product is not necessarily performed.

TI assumes no liability for applications assistance or customer product design. Customers are responsible for their products and applications using TI components. To minimize the risks associated with customer products and applications, customers should provide adequate design and operating safeguards.

TI does not warrant or represent that any license, either express or implied, is granted under any TI patent right, copyright, mask work right, or other TI intellectual property right relating to any combination, machine, or process in which TI products or services are used. Information published by TI regarding third-party products or services does not constitute a license from TI to use such products or services or a warranty or endorsement thereof. Use of such information may require a license from a third party under the patents or other intellectual property of the third party, or a license from TI under the patents or other intellectual property of TI.

Reproduction of TI information in TI data books or data sheets is permissible only if reproduction is without alteration and is accompanied by all associated warranties, conditions, limitations, and notices. Reproduction of this information with alteration is an unfair and deceptive business practice. TI is not responsible or liable for such altered documentation. Information of third parties may be subject to additional restrictions.

Resale of TI products or services with statements different from or beyond the parameters stated by TI for that product or service voids all express and any implied warranties for the associated TI product or service and is an unfair and deceptive business practice. TI is not responsible or liable for any such statements.

TI products are not authorized for use in safety-critical applications (such as life support) where a failure of the TI product would reasonably be expected to cause severe personal injury or death, unless officers of the parties have executed an agreement specifically governing such use. Buyers represent that they have all necessary expertise in the safety and regulatory ramifications of their applications, and acknowledge and agree that they are solely responsible for all legal, regulatory and safety-related requirements concerning their products and any use of TI products in such safety-critical applications, notwithstanding any applications-related information or support that may be provided by TI. Further, Buyers must fully indemnify TI and its representatives against any damages arising out of the use of TI products in such safety-critical applications.

TI products are neither designed nor intended for use in military/aerospace applications or environments unless the TI products are specifically designated by TI as military-grade or "enhanced plastic." Only products designated by TI as military-grade meet military specifications. Buyers acknowledge and agree that any such use of TI products which TI has not designated as military-grade is solely at the Buyer's risk, and that they are solely responsible for compliance with all legal and regulatory requirements in connection with such use.

TI products are neither designed nor intended for use in automotive applications or environments unless the specific TI products are designated by TI as compliant with ISO/TS 16949 requirements. Buyers acknowledge and agree that, if they use any non-designated products in automotive applications, TI will not be responsible for any failure to meet such requirements.

Following are URLs where you can obtain information on other Texas Instruments products and application solutions:

Products

Audio	www.ti.com/audio
Amplifiers	amplifier.ti.com
Data Converters	dataconverter.ti.com
DLP® Products	www.dlp.com
DSP	dsp.ti.com
Clocks and Timers	www.ti.com/clocks
Interface	interface.ti.com
Logic	logic.ti.com
Power Mgmt	power.ti.com
Microcontrollers	microcontroller.ti.com
RFID	www.ti-rfid.com
OMAP Mobile Processors	www.ti.com/omap
Wireless Connectivity	www.ti.com/wirelessconnectivity

Applications

Communications and Telecom	www.ti.com/communications
Computers and Peripherals	www.ti.com/computers
Consumer Electronics	www.ti.com/consumer-apps
Energy and Lighting	www.ti.com/energy
Industrial	www.ti.com/industrial
Medical	www.ti.com/medical
Security	www.ti.com/security
Space, Avionics and Defense	www.ti.com/space-avionics-defense
Transportation and Automotive	www.ti.com/automotive
Video and Imaging	www.ti.com/video

TI E2E Community Home Page

e2e.ti.com

Mailing Address: Texas Instruments, Post Office Box 655303, Dallas, Texas 75265
Copyright © 2011, Texas Instruments Incorporated