

54ABT646

Octal Transceivers and Registers with TRI-STATE® Outputs

General Description

The 54ABT646 consists of bus transceiver circuits with TRI-STATE, D-type flip-flops, and control circuitry arranged for multiplexed transmission of data directly from the input bus or from the internal registers. Data on the A or B bus will be clocked into the registers as the appropriate clock pin goes to a high logic level. Control \overline{OE} and direction pins are provided to control the transceiver function. In the transceiver mode, data present at the high impedance port may be stored in either the A or the B register or in both. The select controls can multiplex stored and real-time (transparent mode) data. The direction control determines which bus will receive data when the enable control \overline{OE} is Active LOW. In the isolation mode (control \overline{OE} HIGH), A data may be stored in the B register and/or B data may be stored in the A register.

Features

- Independent registers for A and B buses
- Multiplexed real-time and stored data
- A and B output sink capability of 48 mA, source capability of 24 mA
- Guaranteed multiple output switching specifications
- Output switching specified for both 50 pF and 250 pF loads
- Guaranteed simultaneous switching noise level and dynamic threshold performance
- Guaranteed latchup protection
- High impedance glitch free bus loading during entire power up and power down cycle
- Nondestructive hot insertion capability
- Standard Microcircuit Drawing (SMD) 5962-9457701

Ordering Code

Military	Package Number	Package Description
54ABT646J-QML	J24A	24-Lead Ceramic Dual-In-Line
54ABT646W-QML	W24C	24-Lead Cerpack
54ABT646E-QML	E28A	28-Lead Ceramic Leadless Chip Carrier, Type C

TRI-STATE® is a registered trademark of National Semiconductor Corporation.

Connection Diagrams

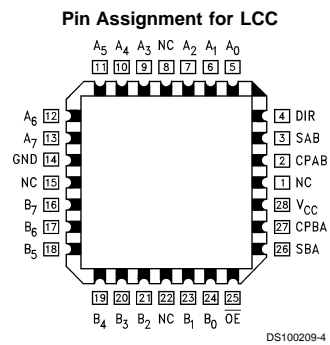
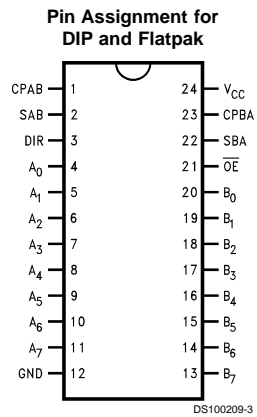

Pin Descriptions

Pin Names	Description
A_0 – A_7	Data Register A Inputs/ TRI-STATE Outputs
B_0 – B_7	Data Register B Inputs/ TRI-STATE Outputs
CPAB, CPBA	Clock Pulse Inputs
SAB, SBA	Select Inputs
\overline{OE}	Output Enable Input
DIR	Direction Control Input

Connection Diagrams (Continued)

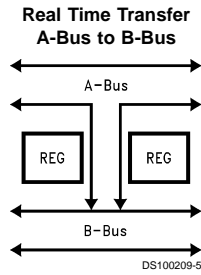

FIGURE 1.

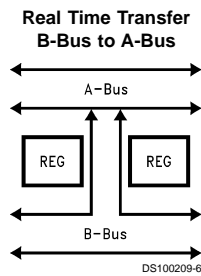

FIGURE 2.

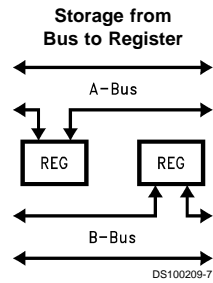

FIGURE 3.

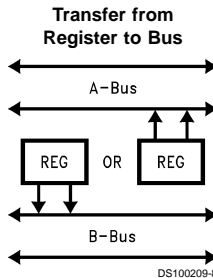

FIGURE 4.

Inputs						Data I/O (Note 1)		Function
O \overline{E}	DIR	CPAB	CPBA	SAB	SBA	A $_0$ -A $_7$	B $_0$ -B $_7$	
H	X	H or L	H or L	X	X			Isolation
H	X	↗	X	X	X	Input	Input	Clock A $_n$ Data into A Register Clock B $_n$ Data into B Register
H	X	X	↗	X	X			
L	H	X	X	L	X	Input	Output	A $_n$ to B $_n$ — Real Time (Transparent Mode) Clock A $_n$ Data into A Register
L	H	↗	X	L	X			Clock A $_n$ Data into A Register
L	H	H or L	X	H	X			A Register to B $_n$ (Stored Mode)
L	H	↗	X	H	X			Clock A $_n$ Data into A Register and Output to B $_n$
L	L	X	X	X	L	Output	Input	B $_n$ to A $_n$ — Real Time (Transparent Mode) Clock B $_n$ Data into B Register
L	L	X	↗	X	L			Clock B $_n$ Data into B Register
L	L	X	H or L	X	H			B Register to A $_n$ (Stored Mode)
L	L	X	↗	X	H			Clock B $_n$ Data into B Register and Output to A $_n$

H = HIGH Voltage Level
L = LOW Voltage Level
X = Immaterial
↗ = LOW-to-HIGH Transition

Note 1: The data output functions may be enabled or disabled by various signals at the $\overline{O\overline{E}}$ and DIR inputs. Data input functions are always enabled; i.e., data at the bus pins will be stored on every LOW-to-HIGH transition of the appropriate clock inputs.

Logic Diagram

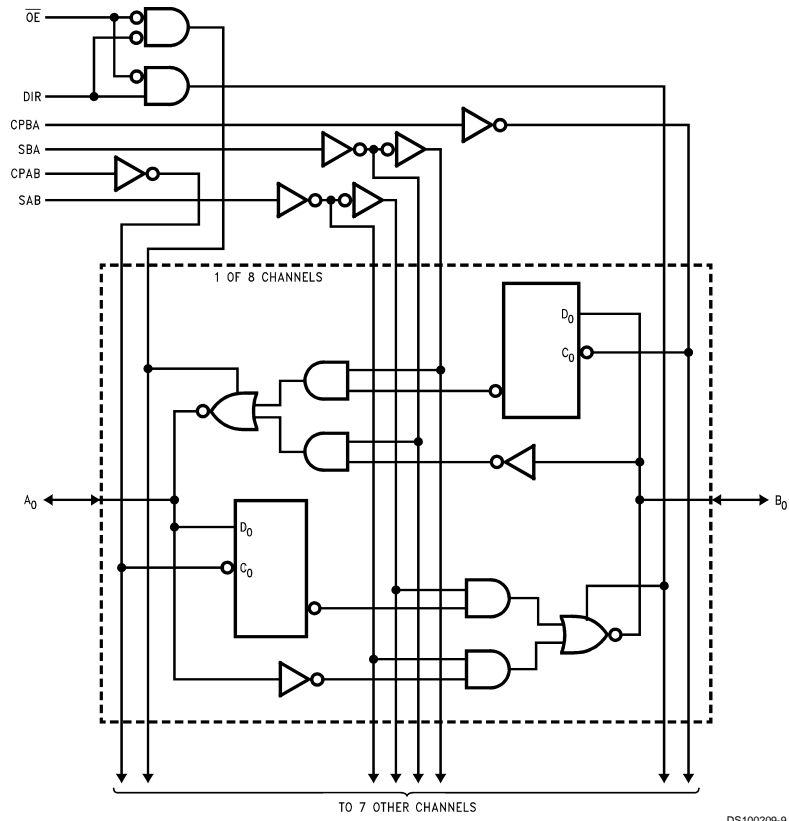

DS100209-9

Please note that this diagram is provided only for the understanding of logic operations and should not be used to estimate propagation delays.

Absolute Maximum Ratings (Note 2)

If Military/Aerospace specified devices are required, please contact the National Semiconductor Sales Office/Distributors for availability and specifications.

Storage Temperature	-65°C to +150°C
Ambient Temperature under Bias	-55°C to +125°C
Junction Temperature under Bias	
Ceramic	-55°C to +175°C
V _{CC} Pin Potential to Ground Pin	-0.5V to +7.0V
Input Voltage (Note 3)	-0.5V to +7.0V
Input Current (Note 3)	-30 mA to +5.0 mA
Voltage Applied to Any Output in the Disable or Power-Off State	-0.5V to +5.5V
in the HIGH State	-0.5V to V _{CC}
Current Applied to Output in LOW State (Max)	twice the rated I _{OL} (mA)
DC Latchup Source Current	-500 mA

Over Voltage Latchup (I/O)

10V

Recommended Operating Conditions

Free Air Ambient Temperature	
Military	-55°C to +125°C
Supply Voltage	
Military	+4.5V to +5.5V
Minimum Input Edge Rate	(ΔV/Δt)
Data Input	50 mV/ns
Enable Input	20 mV/ns
Clock Input	100 mV/ns

Note 2: Absolute maximum ratings are values beyond which the device may be damaged or have its useful life impaired. Functional operation under these conditions is not implied.

Note 3: Either voltage limit or current limit is sufficient to protect inputs.

DC Electrical Characteristics

Symbol	Parameter	ABT646			Units	V _{CC}	Conditions
		Min	Typ	Max			
V _{IH}	Input HIGH Voltage	2.0			V		Recognized HIGH Signal
V _{IL}	Input LOW Voltage		0.8		V		Recognized LOW Signal
V _{CD}	Input Clamp Diode Voltage			-1.2	V	Min	I _{IN} = -18 mA (Non I/O Pins)
V _{OH}	Output HIGH Voltage	2.5			V		I _{OH} = -3 mA, (A _n , B _n)
	54ABT	2.0				Min	I _{OH} = -24 mA, (A _n , B _n)
V _{OL}	Output LOW Voltage		0.55		V	Min	I _{OL} = 48 mA, (A _n , B _n)
V _{ID}	Input Leakage Test	4.75			V	0.0	I _{ID} = 1.9 μA, (Non-I/O Pins) All Other Pins Grounded
I _{IH}	Input HIGH Current		5		μA	Max	V _{IN} = 2.7V (Non-I/O Pins) (Note 5)
			5				V _{IN} = V _{CC} (Non-I/O Pins)
I _{BVI}	Input HIGH Current Breakdown Test		7		μA	Max	V _{IN} = 7.0V (Non-I/O Pins)
I _{BVIT}	Input HIGH Current Breakdown Test (I/O)		100		μA	Max	V _{IN} = 5.5V (A _n , B _n)
I _{IL}	Input LOW Current		-5		μA	Max	V _{IN} = 0.5V (Non-I/O Pins) (Note 5)
			-5				V _{IN} = 0.0V (Non-I/O Pins)
I _{IH} + I _{OZH}	Output Leakage Current		50		μA	0V-5.5V	V _{OUT} = 2.7V (A _n , B _n); \overline{OE} = 2.0V
I _{IL} + I _{OZL}	Output Leakage Current		-50		μA	0V-5.5V	V _{OUT} = 0.5V (A _n , B _n); \overline{OE} = 2.0V
I _{OS}	Output Short-Circuit Current	-100	-275		mA	Max	V _{OUT} = 0V (A _n , B _n)
I _{CEX}	Output HIGH Leakage Current		50		μA	Max	V _{OUT} = V _{CC} (A _n , B _n)
I _{ZZ}	Bus Drainage Test		100		μA	0.0V	V _{OUT} = 5.5V (A _n , B _n); All Others GND
I _{CCH}	Power Supply Current		250		μA	Max	All Outputs HIGH
I _{CCL}	Power Supply Current		30		mA	Max	All Outputs LOW
I _{CCZ}	Power Supply Current		50		μA	Max	Outputs TRI-STATE; All Others GND
I _{CCT}	Additional I _{CC} /Input		2.5		mA	Max	V _I = V _{CC} - 2.1V All Other Outputs at V _{CC} or GND
I _{CCD}	Dynamic I _{CC} (Note 5)	No Load	0.18		mA/MHz	Max	Outputs Open OE and DIR = GND, Non-I/O = GND or V _{CC} (Note 4) One Bit toggling, 50% duty cycle

DC Electrical Characteristics (Continued)

Note 4: For 8-bit toggling, $I_{CCD} < 1.4$ mA/MHz.

Note 5: Guaranteed but not tested.

AC Electrical Characteristics

Symbol	Parameter	54ABT		Units	Fig. No.
		$T_A = -55^\circ\text{C to } +125^\circ\text{C}$ $V_{CC} = 4.5\text{V} - 5.5\text{V}$ $C_L = 50$ pF			
		Min	Max		
f_{max}	Max Clock Frequency	125		MHz	
t_{PLH}	Propagation Delay	2.2	8.8	ns	Figure 8
t_{PHL}	Clock to Bus	1.7	8.8		
t_{PLH}	Propagation Delay	1.5	7.9	ns	Figure 8
t_{PHL}	Bus to Bus	1.5	7.9		
t_{PLH}	Propagation Delay	1.5	8.1	ns	Figure 8
t_{PHL}	SBA or SAB to A_n to B_n	1.5	8.9		
t_{PZH}	Enable Time	1.0	7.3	ns	Figure 10
t_{PZL}	\overline{OE} to A_n or B_n	1.9	8.8		
t_{PHZ}	Disable Time	1.5	9.3	ns	Figure 10
t_{PLZ}	\overline{OE} to A_n or B_n	1.5	9.3		
t_{PZH}	Enable Time	1.0	7.7	ns	Figure 10
t_{PZL}	DIR to A_n or B_n	2.2	9.5		
t_{PHZ}	Disable Time	1.5	8.7	ns	Figure 10
t_{PLZ}	DIR to A_n or B_n	1.5	9.2		

AC Operating Requirements

Symbol	Parameter	54ABT		Units	Fig. No.
		$T_A = -55^\circ\text{C to } +125^\circ\text{C}$ $V_{CC} = 4.5\text{V} - 5.5\text{V}$ $C_L = 50$ pF			
		Min	Max		
$t_S(H)$	Setup Time, HIGH	3.5		ns	Figure 11
$t_S(L)$	or LOW Bus to Clock				
$t_H(H)$	Hold Time, HIGH	1.0		ns	Figure 11
$t_H(L)$	or LOW Bus to Clock				
$t_W(H)$	Pulse Width, HIGH	4.0		ns	Figure 9
$t_W(L)$	HIGH or LOW				

Capacitance

Symbol	Parameter	Typ	Units	Conditions $T_A = 25^\circ\text{C}$
C_{IN}	Input Capacitance	5	pF	$V_{CC} = 0\text{V}$ (non I/O pins)
$C_{I/O}$ (Note 6)	Output Capacitance	11	pF	$V_{CC} = 5.0\text{V}$ (A_n , B_n)

Note 6: $C_{I/O}$ is measured at frequency, $f = 1$ MHz, per MIL-STD-883B, Method 3012.

Capacitance (Continued)

t_{PLH} vs Temperature (T_A)
 $C_L = 50$ pF, 1 Output Switching
 Clock to Bus

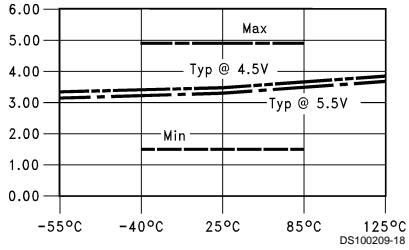

t_{PHL} vs Temperature (T_A)
 $C_L = 50$ pF, 1 Output Switching
 Clock to Bus

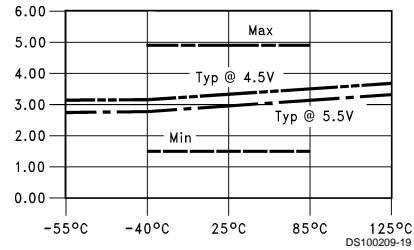

t_{PLH} vs Load Capacitance
 1 Output Switching, $T_A = 25^\circ\text{C}$
 Clock to Bus

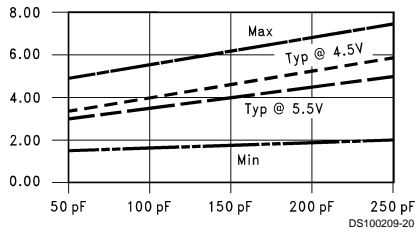

t_{PHL} vs Load Capacitance
 1 Output Switching, $T_A = 25^\circ\text{C}$
 Clock to Bus

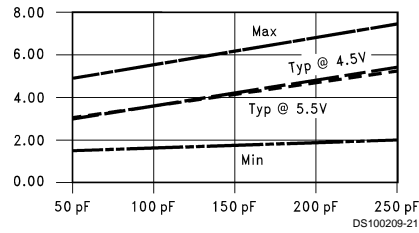

t_{PLH} vs Load Capacitance
 8 Outputs Switching, $T_A = 25^\circ\text{C}$
 Clock to Bus

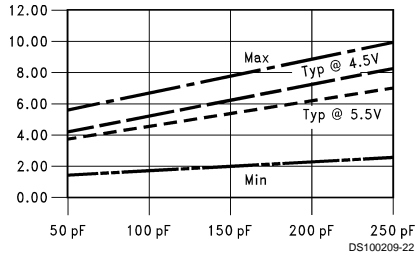

t_{PHL} vs Load Capacitance
 8 Outputs Switching, $T_A = 25^\circ\text{C}$
 Clock to Bus

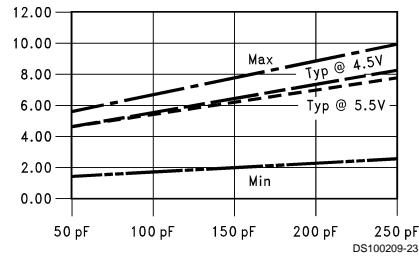

Dashed lines represent design characteristics; for specified guarantees, refer to AC Characteristics Tables.

Capacitance (Continued)

t_{PZL} vs Temperature (T_A)
 $C_L = 50$ pF, 1 Output Switching
 OE to Bus

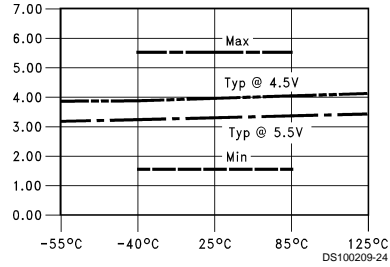

t_{PLZ} vs Temperature (T_A)
 $C_L = 50$ pF, 1 Output Switching
 OE to Bus

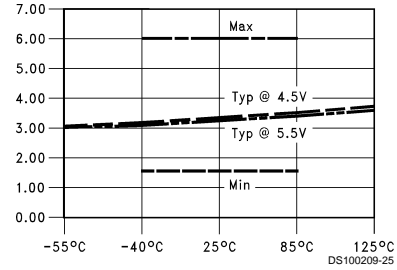

t_{PZH} vs Temperature (T_A)
 $C_L = 50$ pF, 1 Output Switching

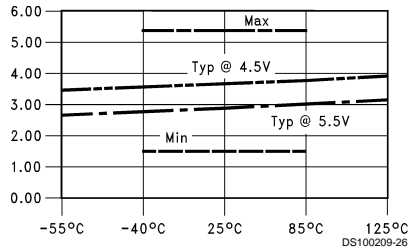

t_{PHZ} vs Temperature (T_A)
 $C_L = 50$ pF, 1 Output Switching
 OE to Bus

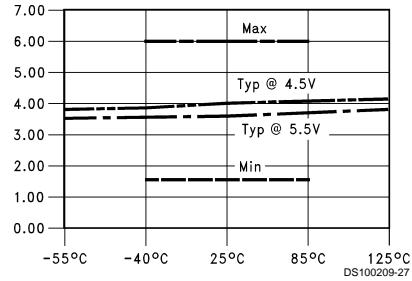

t_{PZH} vs Temperature (T_A)
 $C_L = 50$ pF, 8 Outputs Switching
 OE to Bus

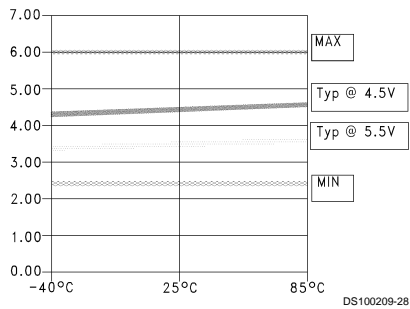

t_{PHZ} vs Temperature (T_A)
 $C_L = 50$ pF, 8 Outputs Switching
 OE to Bus

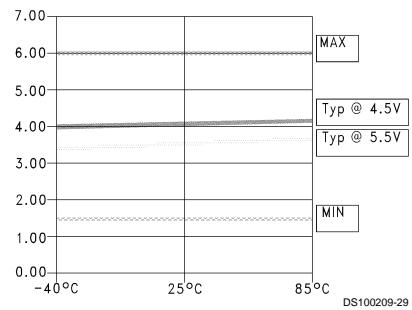

Dashed lines represent design characteristics; for specified guarantees, refer to AC Characteristics Tables.

Capacitance (Continued)

t_{PZL} vs Temperature (T_A)
 $C_L = 50$ pF, 8 Outputs Switching
 OE to Bus

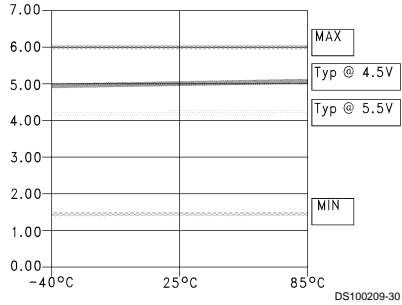

t_{PLZ} vs Temperature (T_A)
 $C_L = 50$ pF, 8 Outputs Switching
 OE to Bus

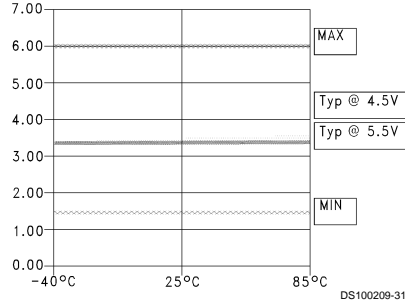

t_{PZL} vs Load Capacitance
 8 Outputs Switching, $T_A = 25^\circ\text{C}$
 OE to Bus

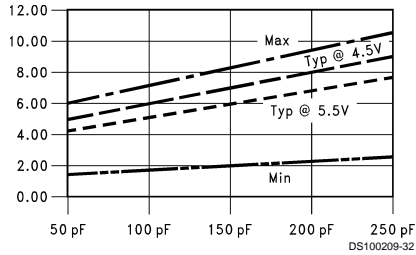

t_{PZH} vs Load Capacitance
 8 Outputs Switching, $T_A = 25^\circ\text{C}$
 OE to Bus

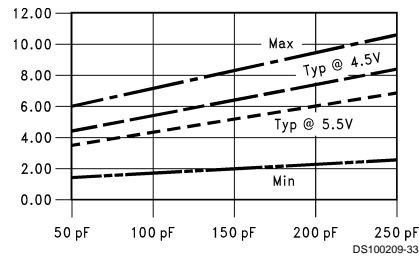

t_{PLH} and t_{PHL} vs Number Output Switching
 $V_{CC} = 5.0\text{V}$, $T_A = 25^\circ\text{C}$
 $C_L = 50$ pF, Clock to Bus

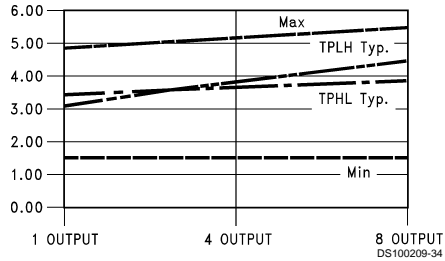

Dashed lines represent design characteristics; for specified guarantees, refer to AC Characteristics Tables.

Capacitance (Continued)

I_{CC} vs Frequency, Average,
 $T_A = 25^\circ\text{C}$, $V_{CC} = 5.5\text{V}$
 All Outputs Unloaded/Unterminated;
 All Outputs Switching in phase @50% Duty Cycle

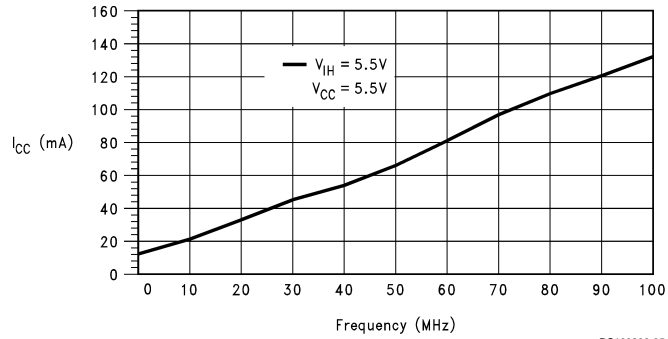

DS100209-35

t_{SET} LOW vs Temperature (T_A)
 $C_L = 50\text{ pF}$, 1 Output Switching
 Bus to Clock

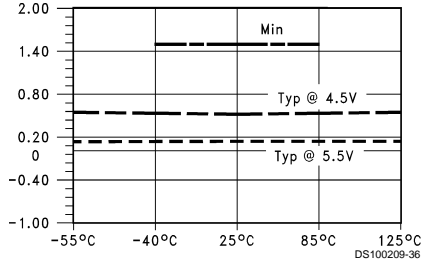

DS100209-36

t_{SET} HIGH vs Temperature (T_A)
 $C_L = 50\text{ pF}$, 1 Output Switching
 Bus to Clock

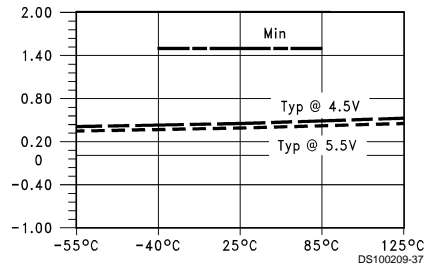

DS100209-37

t_{HOLD} LOW vs Temperature (T_A)
 $C_L = 50\text{ pF}$, 1 Output Switching
 Bus to Clock

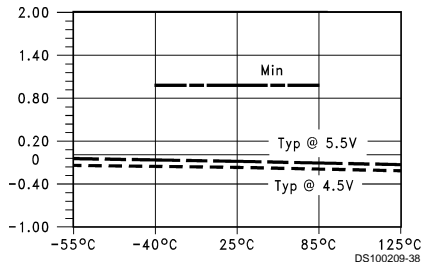

DS100209-38

t_{HOLD} HIGH vs Temperature (T_A)
 $C_L = 50\text{ pF}$, 1 Output Switching
 Bus to Clock

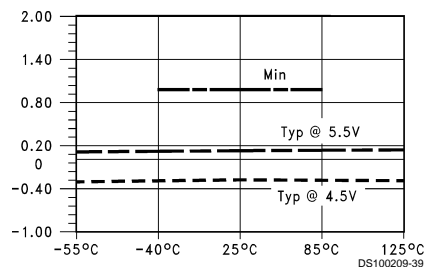

DS100209-39

Dashed lines represent design characteristics; for specified guarantees, refer to AC Characteristics Tables.

AC Loading

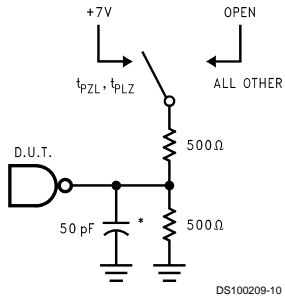

*Includes jig and probe capacitance

FIGURE 5. Standard AC Test Load

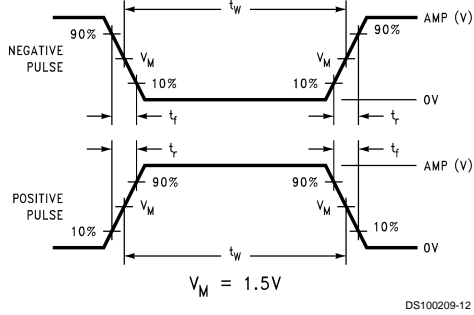

FIGURE 6. Test Input Signal Levels
Input Pulse Requirements

Amplitude	Rep. Rate	t_w	t_r	t_f
3.0V	1 MHz	500 ns	2.5 ns	2.5 ns

FIGURE 7. Test Input Signal Requirements

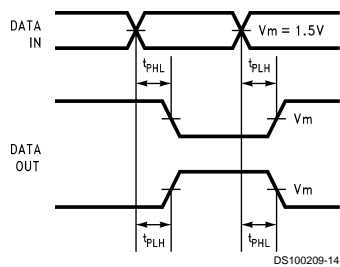

FIGURE 8. Propagation Delay Waveforms for Inverting and Non-Inverting Functions

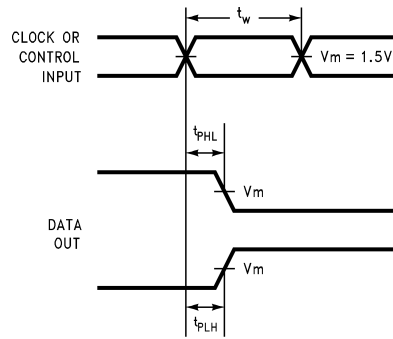

FIGURE 9. Propagation Delay,
Pulse Width Waveforms

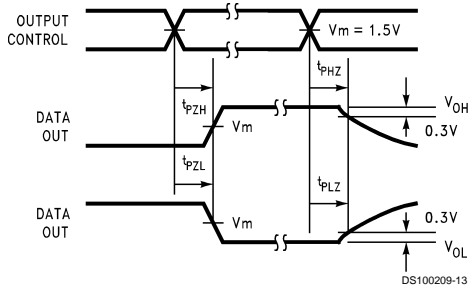

FIGURE 10. TRI-STATE Output HIGH
and LOW Enable and Disable Times

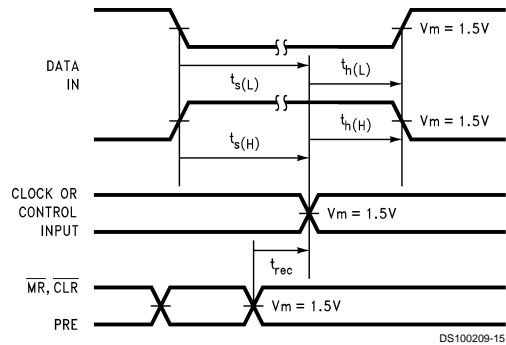
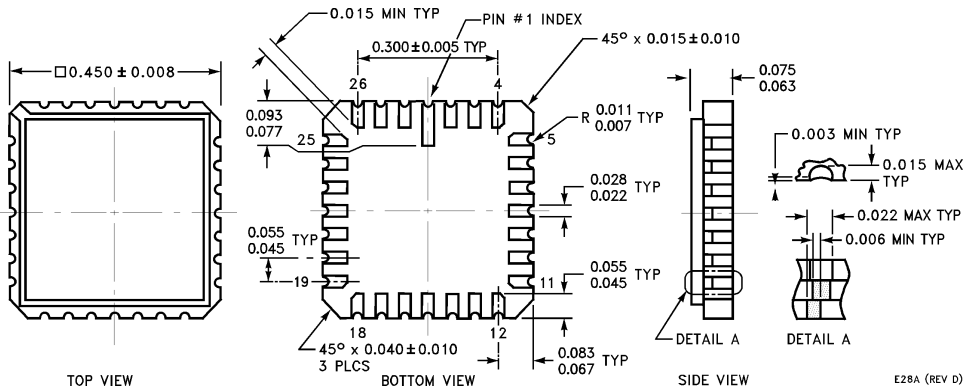

FIGURE 11. Setup Time, Hold Time
and Recovery Time Waveforms



Physical Dimensions inches (millimeters) unless otherwise noted



28-Lead Ceramic Leadless Chip Carrier (L)
NS Package Number E28A

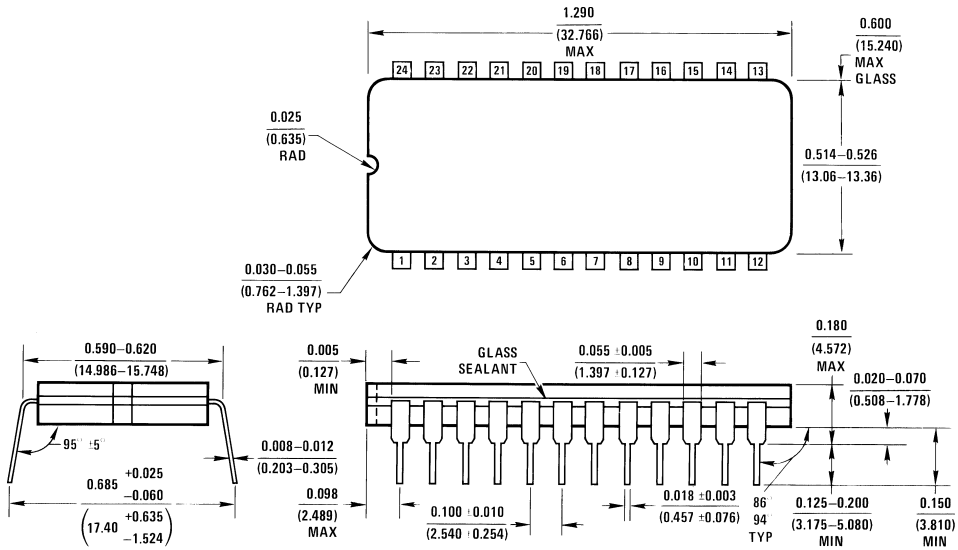

24-Lead Ceramic Dual-in-Line Package (D)
NS Package Number J24A

Physical Dimensions inches (millimeters) unless otherwise noted (Continued)

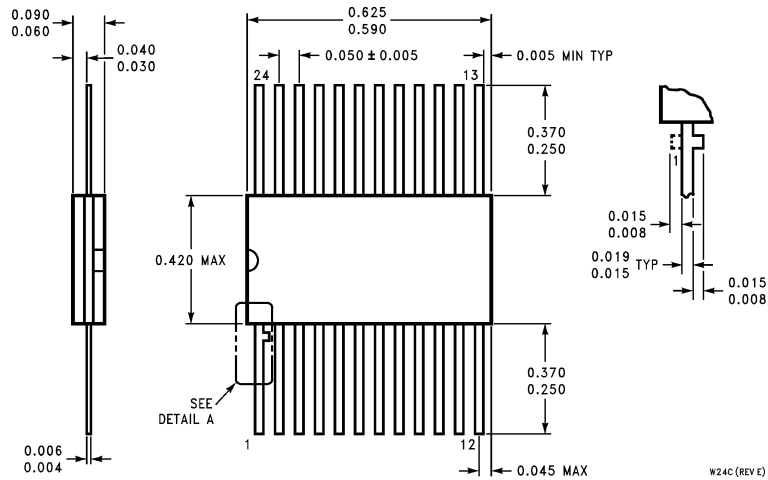

24-Lead Ceramic Flatpak Package (F)
NS Package Number W24C

LIFE SUPPORT POLICY

NATIONAL'S PRODUCTS ARE NOT AUTHORIZED FOR USE AS CRITICAL COMPONENTS IN LIFE SUPPORT DEVICES OR SYSTEMS WITHOUT THE EXPRESS WRITTEN APPROVAL OF THE PRESIDENT OF NATIONAL SEMICONDUCTOR CORPORATION. As used herein:

1. Life support devices or systems are devices or systems which, (a) are intended for surgical implant into the body, or (b) support or sustain life, and whose failure to perform when properly used in accordance with instructions for use provided in the labeling, can be reasonably expected to result in a significant injury to the user.
2. A critical component in any component of a life support device or system whose failure to perform can be reasonably expected to cause the failure of the life support device or system, or to affect its safety or effectiveness.



National Semiconductor Corporation
 Americas
 Tel: 1-800-272-9959
 Fax: 1-800-737-7018
 Email: support@nsc.com

National Semiconductor Europe
 Fax: +49 (0) 1 80-530 85 86
 Email: europe.support@nsc.com
 Deutsch Tel: +49 (0) 1 80-530 85 85
 English Tel: +49 (0) 1 80-532 78 32
 Français Tel: +49 (0) 1 80-532 93 58
 Italiano Tel: +49 (0) 1 80-534 16 80

National Semiconductor Asia Pacific Customer Response Group
 Tel: 65-2544466
 Fax: 65-2504466
 Email: sea.support@nsc.com

National Semiconductor Japan Ltd.
 Tel: 81-3-5620-6175
 Fax: 81-3-5620-6179

www.national.com