

54ABT573

54ABT573 Octal D-Type Latch with TRI-STATE Outputs



Literature Number: SNOS048

54ABT573

Octal D-Type Latch with TRI-STATE® Outputs

General Description

The 'ABT573 is an octal latch with buffered common Latch Enable (LE) and buffered common Output Enable (\overline{OE}) inputs.

This device is functionally identical to the 'ABT373 but has different pinouts.

Features

- Inputs and outputs on opposite sides of package allow easy interface with microprocessors
- Useful as input or output port for microprocessors

- Functionally identical to 'ABT373
- TRI-STATE outputs for bus interfacing
- Output sink capability of 48 mA, source capability of 24 mA
- Output switching specified for both 50 pF and 250 pF loads
- Guaranteed latchup protection
- High impedance glitch-free bus loading during entire power up and power down
- Nondestructive hot insertion capability
- Standard Microcircuit Drawing (SMD) 5962-9321901

Ordering Code

Military	Package Number	Package Description
54ABT573J-QML	J20A	20-Lead Ceramic Dual-In-Line
54ABT573W-QML	W20A	20-Lead Cerpack
54ABT573E-QML	E20A	20-Lead Ceramic Leadless Chip Carrier, Type C

Connection Diagram

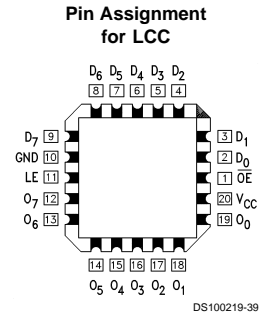
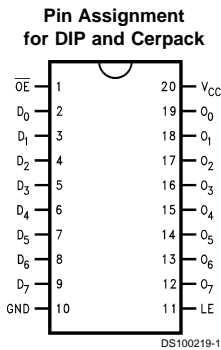

Pin Names	Description
D ₀ -D ₇	Data Inputs
LE	Latch Enable Input (Active HIGH)
\overline{OE}	TRI-STATE Output Enable Input (Active LOW)
O ₀ -O ₇	TRI-STATE Latch Outputs

TRI-STATE® is a registered trademark of National Semiconductor Corporation.

Functional Description

The 'ABT573 contains eight D-type latches with TRI-STATE output buffers. When the Latch Enable (LE) input is HIGH, data on the D_n inputs enters the latches. In this condition the latches are transparent, i.e., a latch output will change state each time its D input changes. When LE is LOW the latches store the information that was present on the D inputs a setup time preceding the HIGH-to-LOW transition of LE. The TRI-STATE buffers are controlled by the Output Enable (\overline{OE}) input. When \overline{OE} is LOW, the buffers are in the bi-state mode. When \overline{OE} is HIGH the buffers are in the high impedance mode but this does not interfere with entering new data into the latches.

Function Table

Inputs			Outputs
\overline{OE}	LE	D	O
L	H	H	H
L	H	L	L
L	L	X	O_0
H	X	X	Z

H = HIGH Voltage Level
 L = LOW Voltage Level
 X = Immaterial
 O_0 = Value stored from previous clock cycle

Logic Diagram

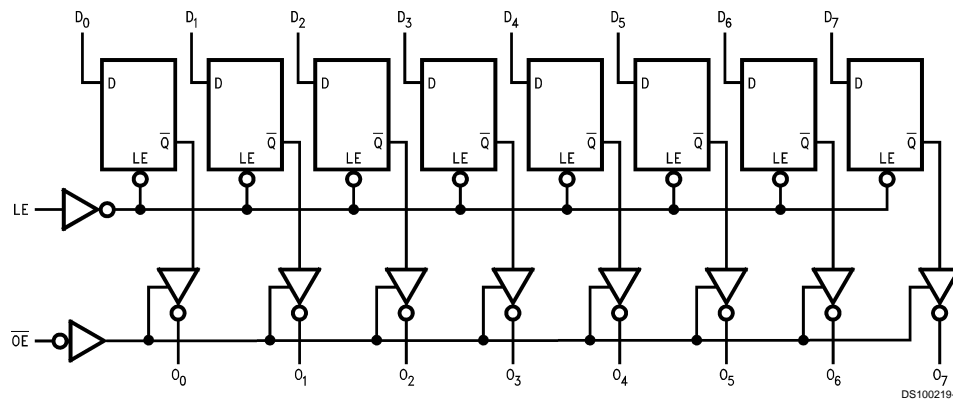

Please note that this diagram is provided only for the understanding of logic operations and should not be used to estimate propagation delays.

DS100219-3

Absolute Maximum Ratings (Note 1)

Storage Temperature	-65°C to +150°C
Ambient Temperature under Bias	-55°C to +125°C
Junction Temperature under Bias	
Ceramic	-55°C to +175°C
V _{CC} Pin Potential to Ground Pin	-0.5V to +7.0V
Input Voltage (Note 2)	-0.5V to +7.0V
Input Current (Note 2)	-30 mA to +5.0 mA
Voltage Applied to Any Output in the Disabled or Power-Off State in the HIGH State	-0.5V to +5.5V -0.5V to V _{CC}
Current Applied to Output in LOW State (Max)	Twice the rated I _{OL} (mA)
DC Latchup Source Current	-500 mA

Over Voltage Latchup (I/O)

10V

Recommended Operating Conditions

Free Air Ambient Temperature	
Military	-55°C to +125°C
Supply Voltage	
Military	+4.5V to +5.5V
Minimum Input Edge Rate	(ΔV/Δt)
Data Input	50 mV/ns
Enable Input	20 mV/ns

Note 1: Absolute maximum ratings are values beyond which the device may be damaged or have its useful life impaired. Functional operation under these conditions is not implied.

Note 2: Either voltage limit or current limit is sufficient to protect inputs.

DC Electrical Characteristics

Symbol	Parameter	ABT573			Units	V _{CC}	Conditions
		Min	Typ	Max			
V _{IH}	Input HIGH Voltage	2.0			V		Recognized HIGH Signal
V _{IL}	Input LOW Voltage		0.8		V		Recognized LOW Signal
V _{CD}	Input Clamp Diode Voltage			-1.2	V	Min	I _{IN} = -18 mA
V _{OH}	Output HIGH Voltage	54ABT	2.5		V	Min	I _{OH} = -3 mA
		54ABT	2.0				I _{OH} = -24 mA
V _{OL}	Output LOW Voltage	54ABT		0.55	V	Min	I _{OL} = 48 mA
I _{IH}	Input HIGH Current			5	μA	Max	V _{IN} = 2.7V (Note 4)
				5			V _{IN} = V _{CC}
I _{BVI}	Input HIGH Current Breakdown Test			7	μA	Max	V _{IN} = 7.0V
I _{IL}	Input LOW Current			-5	μA	Max	V _{IN} = 0.5V (Note 4)
				-5			V _{IN} = 0.0V
V _{ID}	Input Leakage Test	4.75			V	0.0	I _{ID} = 1.9 μA All Other Pins Grounded
I _{OZH}	Output Leakage Current			50	μA	0 - 5.5V	V _{OUT} = 2.7V; \overline{OE} = 2.0V
I _{OZL}	Output Leakage Current			-50	μA	0 - 5.5V	V _{OUT} = 0.5V; \overline{OE} = 2.0V
I _{OS}	Output Short-Circuit Current	-100		-275	mA	Max	V _{OUT} = 0.0V
I _{CEX}	Output High Leakage Current			50	μA	Max	V _{OUT} = V _{CC}
I _{ZZ}	Bus Drainage Test			100	μA	0.0	V _{OUT} = 5.5V; All Others GND
I _{CCH}	Power Supply Current			50	μA	Max	All Outputs HIGH
I _{CCL}	Power Supply Current			30	mA	Max	All Outputs LOW
I _{CCZ}	Power Supply Current			50	μA	Max	\overline{OE} = V _{CC} All Others at V _{CC} or GND
I _{CCT}	Additional I _{CC} /Input	Outputs Enabled		2.5	mA		V _I = V _{CC} - 2.1V
		Outputs TRI-STATE		2.5	mA	Max	Enable Input V _I = V _{CC} - 2.1V
		Outputs TRI-STATE		2.5	mA		Data Input V _I = V _{CC} - 2.1V All Others at V _{CC} or GND
I _{CCD}	Dynamic I _{CC} (Note 4)	No Load			mA/ MHz	Max	Outputs Open \overline{OE} = GND, LE = V _{CC} (Note 3) One Bit Toggling, 50% Duty Cycle

Note 3: For 8 bits toggling, I_{CCD} < 0.8 mA/MHz.

Note 4: Guaranteed but not tested.

DC Electrical Characteristics

Symbol	Parameter	Min	Max	Units	V _{CC}	Conditions C _L = 50 pF, R _L = 500Ω
V _{OLP}	Quiet Output Maximum Dynamic V _{OL}		0.9	V	5.0	T _A = 25°C (Note 5)
V _{OLV}	Quiet Output Minimum Dynamic V _{OL}		-1.7	V	5.0	T _A = 25°C (Note 5)

Note 5: Max number of outputs defined as (n). n – 1 data inputs are driven 0V to 3V. One output at LOW. Guaranteed, but not tested.

AC Electrical Characteristics

Symbol	Parameter	54ABT		Units	Fig. No.
		T _A = –55°C to +125°C V _{CC} = 4.5V to 5.5V C _L = 50 pF			
		Min	Max		
t _{PLH}	Propagation Delay	1.0	6.4	ns	Figure 4
t _{PHL}	D _n to O _n	1.5	6.7		
t _{PLH}	Propagation Delay	1.0	7.1	ns	Figure 4
t _{PHL}	LE to O _n	1.5	7.5		
t _{PZH}	Output Enable Time	0.8	6.5	ns	Figure 6
t _{PZL}		1.5	7.2		
t _{PHZ}	Output Disable Time	1.5	7.7	ns	Figure 6
t _{PLZ}	Time	1.0	7.0		

AC Operating Requirements

Symbol	Parameter	54ABT		Units	Fig. No.
		T _A = –55°C to +125°C V _{CC} = 4.5V to 5.5V C _L = 50 pF			
		Min	Max		
t _s (H)	Set Time, HIGH	2.5		ns	Figure 7
t _s (L)	or LOW D _n to LE	2.5			
t _h (H)	Hold Time, HIGH	2.5		ns	Figure 7
t _h (L)	or LOW D _n to LE	2.5			
t _w (H)	Pulse Width, LE HIGH	3.3		ns	Figure 5

Capacitance

Symbol	Parameter	Typ	Units	Conditions (T _A = 25°C)
C _{IN}	Input Capacitance	5	pF	V _{CC} = 0V
C _{OUT} (Note 6)	Output Capacitance	9	pF	V _{CC} = 5.0V

Note 6: C_{OUT} is measured at frequency f = 1 MHz per MIL-STD-883B, Method 3012.

Capacitance (Continued)

**T_{PLH} vs Temperature (T_A), $C_L = 50$ pF,
1 Output Switching, Data to Output**

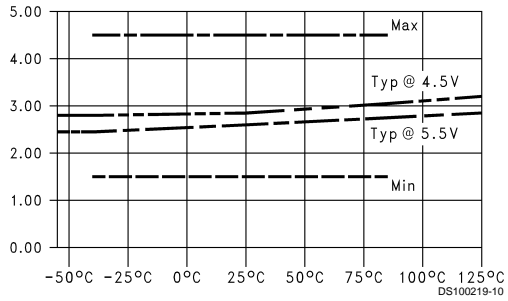

**T_{PHL} vs Temperature (T_A), $C_L = 50$ pF,
1 Output Switching, Data to Output**

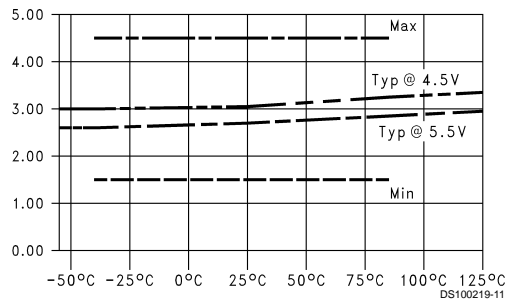

**T_{PZH} vs Temperature (T_A), $C_L = 50$ pF,
1 Output Switching, OE to Output**

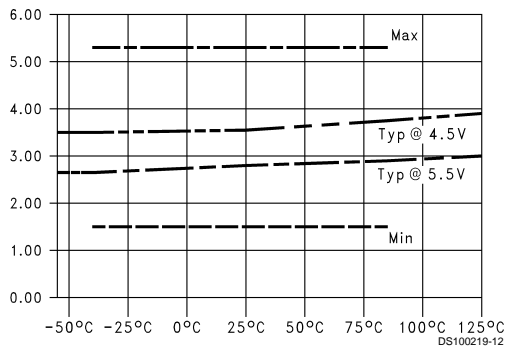

**T_{PZL} vs Temperature (T_A), $C_L = 50$ pF,
1 Output Switching, OE to Output**

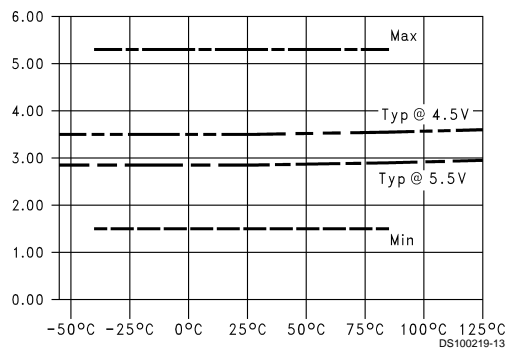

Dashed lines represent design characteristics; for specified guarantees, refer to AC Characteristics Tables.

Capacitance (Continued)

**T_{PHZ} vs Temperature (T_A), $C_L = 50$ pF,
1 Output Switching, OE to Output**

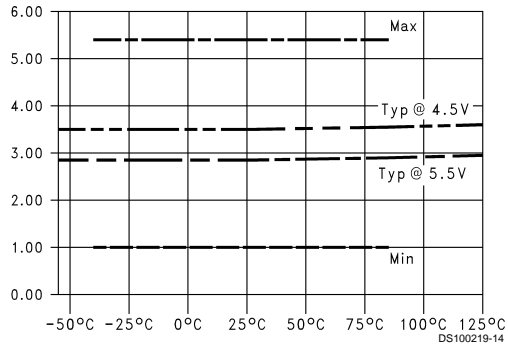

**T_{PLZ} vs Temperature (T_A), $C_L = 50$ pF,
1 Output Switching, OE to Output**

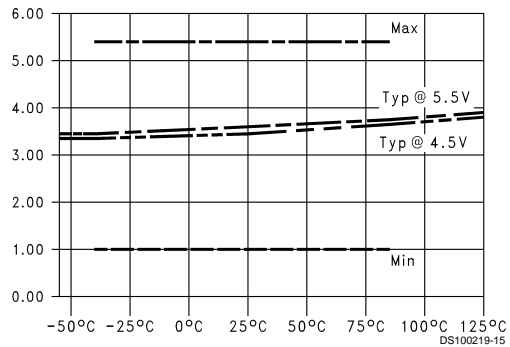

**T_{SET} LOW vs Temperature (T_A), $C_L = 50$ pF,
1 Output Switching, Data to LE**

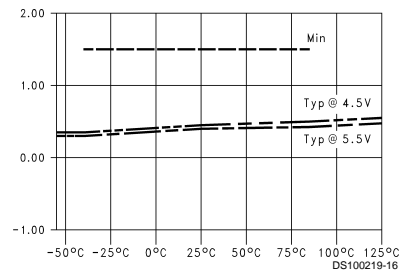

**T_{SET} HIGH vs Temperature (T_A), $C_L = 50$ pF,
1 Output Switching, Data to LE**

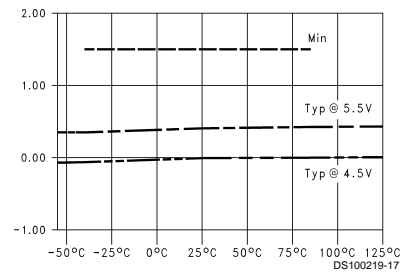

**T_{HOLD} HIGH vs Temperature (T_A), $C_L = 50$ pF,
1 Output Switching, Data to LE**

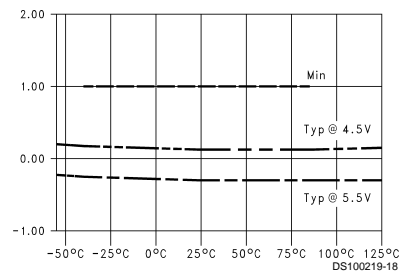

**T_{HOLD} LOW vs Temperature (T_A), $C_L = 50$ pF,
1 Output Switching, Data to LE**

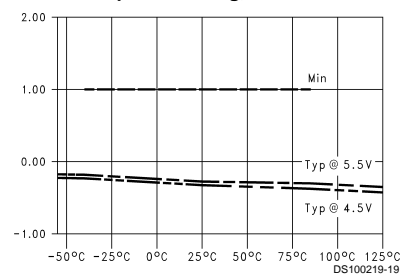

Dashed lines represent design characteristics; for specified guarantees, refer to AC Characteristics Tables.

Capacitance (Continued)

**T_{PLH} vs Temperature (T_A), $C_L = 50$ pF,
8 Outputs Switching, Data to Output**

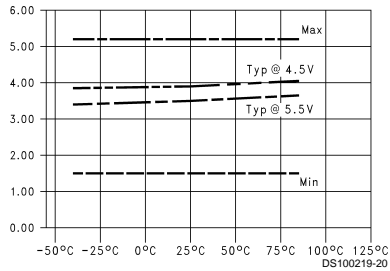

**T_{PHL} vs Temperature (T_A), $C_L = 50$ pF,
8 Outputs Switching, Data to Output**

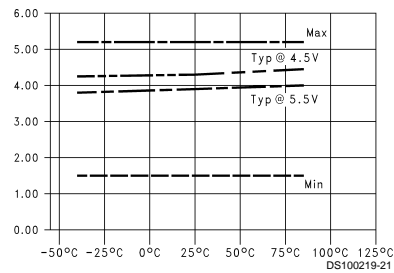

**T_{PZH} vs Temperature (T_A), $C_L = 50$ pF,
8 Outputs Switching, OE to Output**

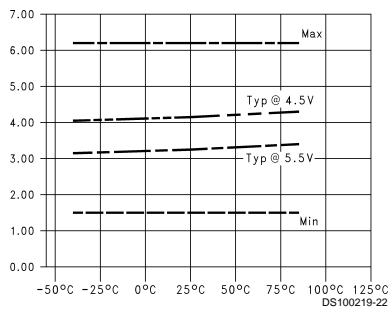

**T_{PZL} vs Temperature (T_A), $C_L = 50$ pF,
8 Outputs Switching, OE to Output**

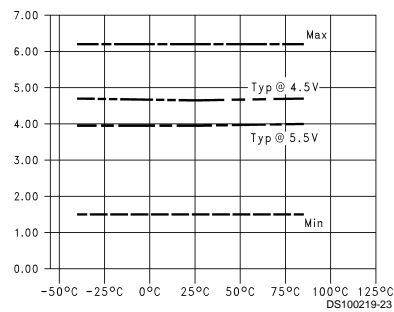

**T_{PHZ} vs Temperature (T_A), $C_L = 50$ pF,
8 Outputs Switching, OE to Output**

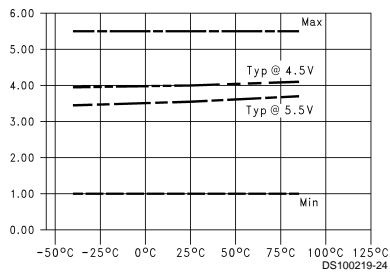

**T_{PLZ} vs Temperature (T_A), $C_L = 50$ pF,
8 Outputs Switching, OE to Output**

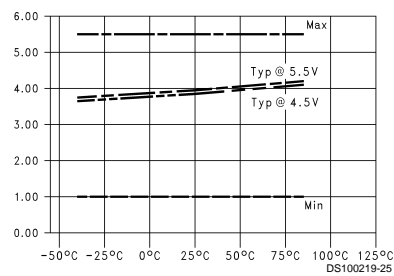

Dashed lines represent design characteristics; for specified guarantees, refer to AC Characteristics Tables.

Capacitance (Continued)

**T_{PLH} vs Load Capacitance $T_A = 25^\circ\text{C}$,
1 Output Switching, Data to Output**

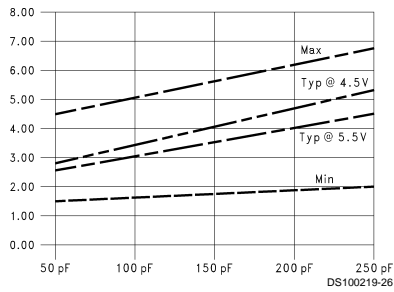

**T_{PHL} vs Load Capacitance $T_A = 25^\circ\text{C}$,
1 Output Switching, Data to Output**

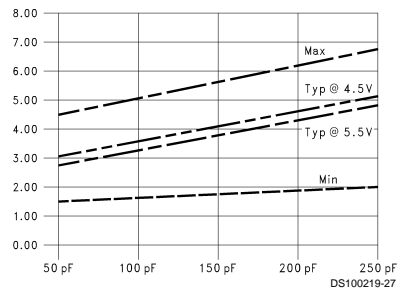

**T_{PLH} vs Load Capacitance $T_A = 25^\circ\text{C}$,
8 Outputs Switching, Data to Output**

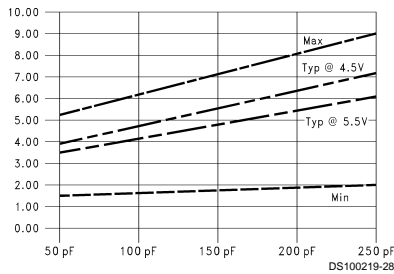

**T_{PHL} vs Load Capacitance $T_A = 25^\circ\text{C}$,
8 Outputs Switching, Data to Output**

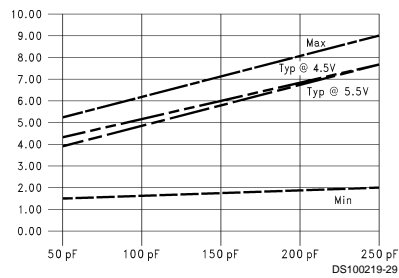

**T_{PZH} vs Load Capacitance $T_A = 25^\circ\text{C}$,
8 Outputs Switching, OE to Output**

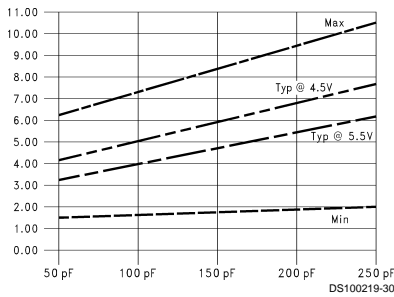

**T_{PZL} vs Load Capacitance $T_A = 25^\circ\text{C}$,
8 Outputs Switching, OE to Output**

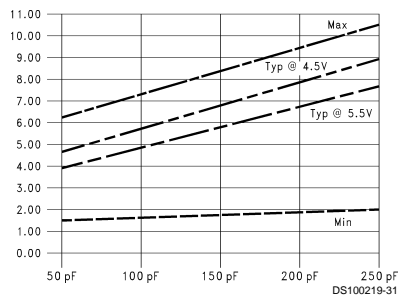

Dashed lines represent design characteristics; for specified guarantees, refer to AC Characteristics Tables.

Capacitance (Continued)

**T_{PLH} vs Temperature (T_A), $C_L = 50$ pF,
1 Output Switching, LE to Output**

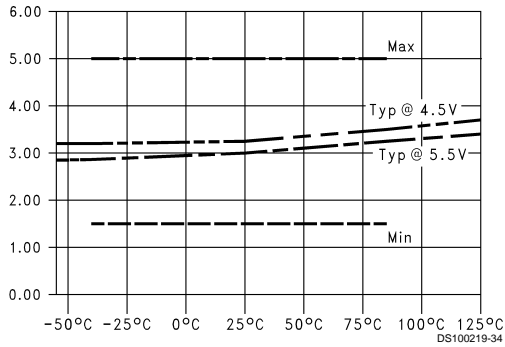

**T_{PHL} vs Temperature (T_A), $C_L = 50$ pF,
1 Output Switching, LE to Output**

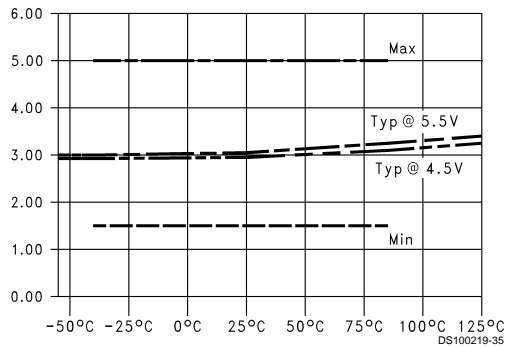

**T_{PLH} vs Temperature (T_A), $C_L = 50$ pF,
8 Outputs Switching, LE to Output**

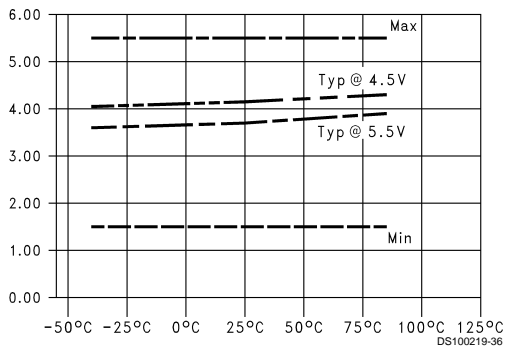

**T_{PHL} vs Temperature (T_A), $C_L = 50$ pF,
8 Outputs Switching, LE to Output**

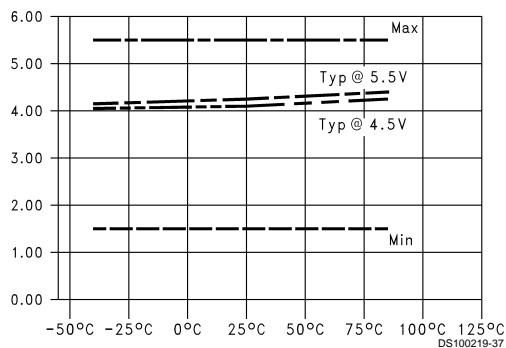

**T_{PLH} and T_{PHL} vs Number Outputs Switching,
 $C_L = 50$ pF, $T_A = 25^\circ\text{C}$, $V_{CC} = 5.0\text{V}$,
Outputs In Phase Data to Output**

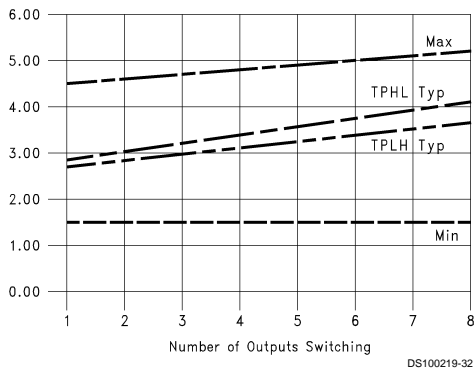

**Typical I_{CC} vs Output Switching Frequency,
 $C_L = 0$ pF, $V_{CC} = V_{IH} = 5.5\text{V}$, LE = GND,
1 Output Switching at 50% Duty Cycle, Data to Output,
Transparent Mode with Unused Data Inputs = V_{IH}**

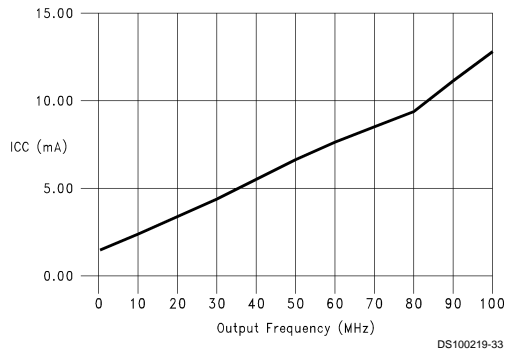

Dashed lines represent design characteristics; for specified guarantees, refer to AC Characteristics Tables.

AC Loading

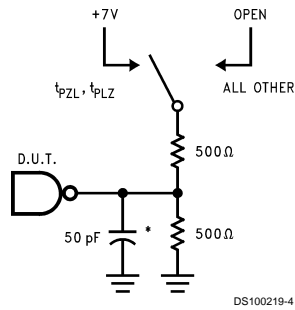

*Includes jig and probe capacitance

FIGURE 1. Test Load

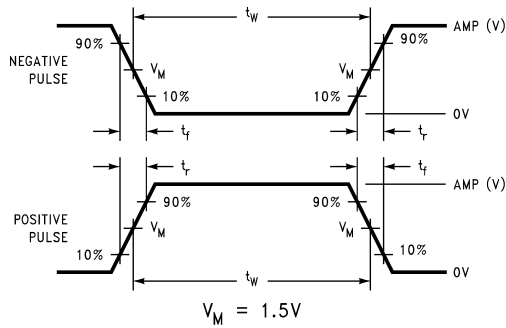

FIGURE 2. Test Input Signal Levels

Amplitude	Rep. Rate	t_w	t_r	t_f
3.0V	1 MHz	500 ns	2.5 ns	2.5 ns

FIGURE 3. Test Input Signal Requirements

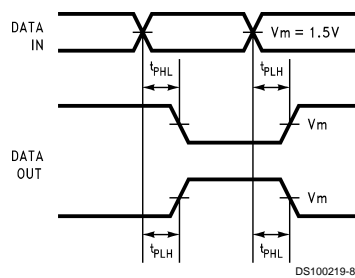

FIGURE 4. Propagation Delay Waveforms for Inverting and Non-Inverting Functions

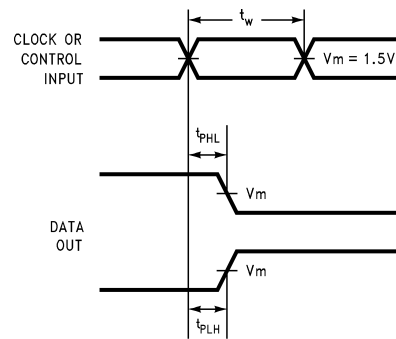

FIGURE 5. Propagation Delay, Pulse Width Waveforms

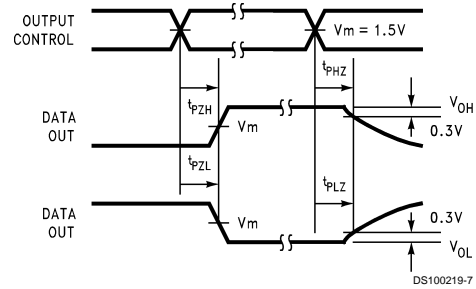

FIGURE 6. TRI-STATE Output HIGH and LOW Enable and Disable Times

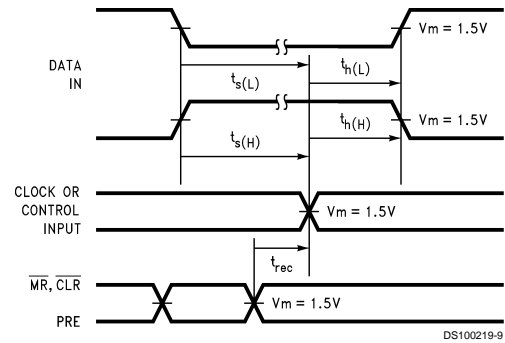
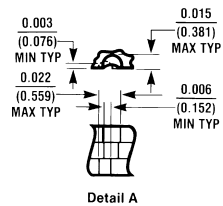
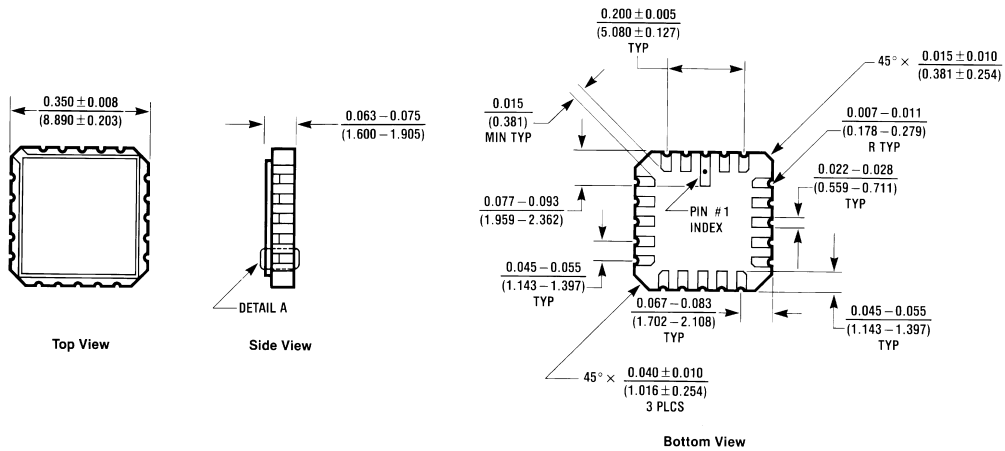

FIGURE 7. Setup Time, Hold Time and Recovery Time Waveforms

Physical Dimensions inches (millimeters) unless otherwise noted



E20A (REV D)

20-Lead Ceramic Leadless Chip Carrier
NS Package Number E20A

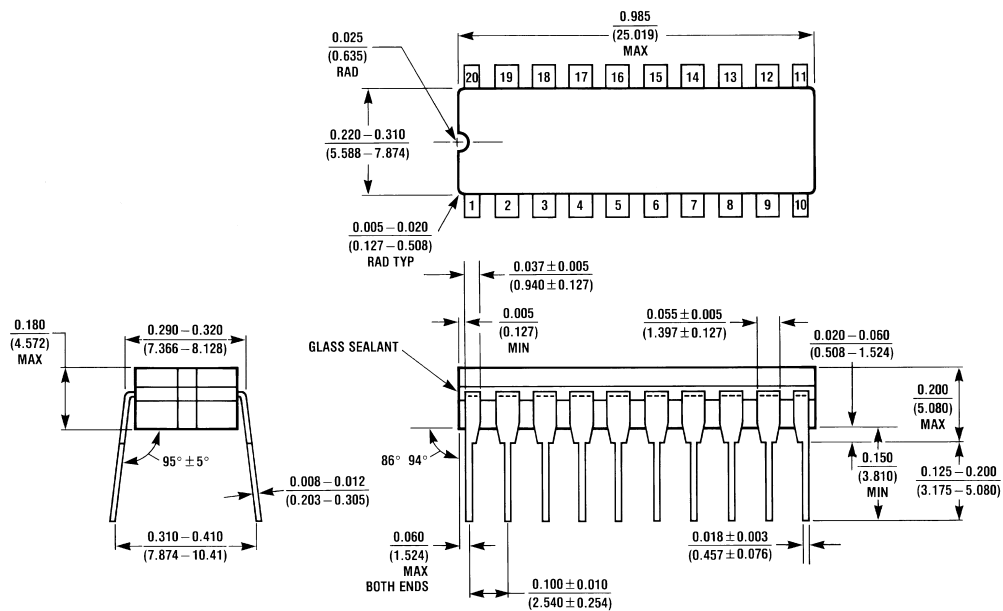

J20A (REV M)

20-Lead Ceramic Dual-In-Line
NS Package Number J20A

Physical Dimensions inches (millimeters) unless otherwise noted (Continued)

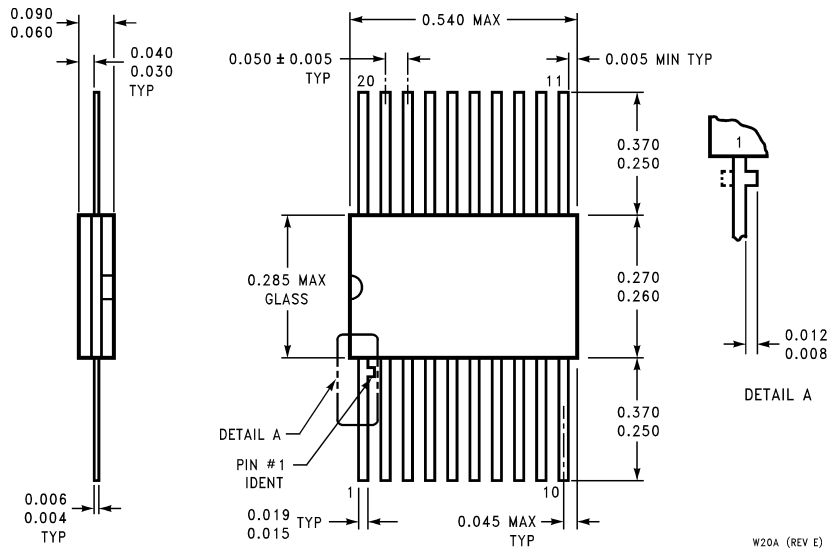

**20-Lead Ceramic Flatpack
NS Package Number W20A**

LIFE SUPPORT POLICY

NATIONAL'S PRODUCTS ARE NOT AUTHORIZED FOR USE AS CRITICAL COMPONENTS IN LIFE SUPPORT DEVICES OR SYSTEMS WITHOUT THE EXPRESS WRITTEN APPROVAL OF THE PRESIDENT OF NATIONAL SEMICONDUCTOR CORPORATION. As used herein:

1. Life support devices or systems are devices or systems which, (a) are intended for surgical implant into the body, or (b) support or sustain life, and whose failure to perform when properly used in accordance with instructions for use provided in the labeling, can be reasonably expected to result in a significant injury to the user.
2. A critical component in any component of a life support device or system whose failure to perform can be reasonably expected to cause the failure of the life support device or system, or to affect its safety or effectiveness.



National Semiconductor Corporation
Americas
Tel: 1-800-272-9959
Fax: 1-800-737-7018
Email: support@nsc.com

National Semiconductor Europe
Fax: +49 (0) 1 80-530 85 86
Email: europe.support@nsc.com
Deutsch Tel: +49 (0) 1 80-530 85 85
English Tel: +49 (0) 1 80-532 78 32
Français Tel: +49 (0) 1 80-532 93 58
Italiano Tel: +49 (0) 1 80-534 16 80

National Semiconductor Asia Pacific Customer Response Group
Tel: 65-2544466
Fax: 65-2504466
Email: sea.support@nsc.com

National Semiconductor Japan Ltd.
Tel: 81-3-5620-6175
Fax: 81-3-5620-6179

www.national.com

IMPORTANT NOTICE

Texas Instruments Incorporated and its subsidiaries (TI) reserve the right to make corrections, modifications, enhancements, improvements, and other changes to its products and services at any time and to discontinue any product or service without notice. Customers should obtain the latest relevant information before placing orders and should verify that such information is current and complete. All products are sold subject to TI's terms and conditions of sale supplied at the time of order acknowledgment.

TI warrants performance of its hardware products to the specifications applicable at the time of sale in accordance with TI's standard warranty. Testing and other quality control techniques are used to the extent TI deems necessary to support this warranty. Except where mandated by government requirements, testing of all parameters of each product is not necessarily performed.

TI assumes no liability for applications assistance or customer product design. Customers are responsible for their products and applications using TI components. To minimize the risks associated with customer products and applications, customers should provide adequate design and operating safeguards.

TI does not warrant or represent that any license, either express or implied, is granted under any TI patent right, copyright, mask work right, or other TI intellectual property right relating to any combination, machine, or process in which TI products or services are used. Information published by TI regarding third-party products or services does not constitute a license from TI to use such products or services or a warranty or endorsement thereof. Use of such information may require a license from a third party under the patents or other intellectual property of the third party, or a license from TI under the patents or other intellectual property of TI.

Reproduction of TI information in TI data books or data sheets is permissible only if reproduction is without alteration and is accompanied by all associated warranties, conditions, limitations, and notices. Reproduction of this information with alteration is an unfair and deceptive business practice. TI is not responsible or liable for such altered documentation. Information of third parties may be subject to additional restrictions.

Resale of TI products or services with statements different from or beyond the parameters stated by TI for that product or service voids all express and any implied warranties for the associated TI product or service and is an unfair and deceptive business practice. TI is not responsible or liable for any such statements.

TI products are not authorized for use in safety-critical applications (such as life support) where a failure of the TI product would reasonably be expected to cause severe personal injury or death, unless officers of the parties have executed an agreement specifically governing such use. Buyers represent that they have all necessary expertise in the safety and regulatory ramifications of their applications, and acknowledge and agree that they are solely responsible for all legal, regulatory and safety-related requirements concerning their products and any use of TI products in such safety-critical applications, notwithstanding any applications-related information or support that may be provided by TI. Further, Buyers must fully indemnify TI and its representatives against any damages arising out of the use of TI products in such safety-critical applications.

TI products are neither designed nor intended for use in military/aerospace applications or environments unless the TI products are specifically designated by TI as military-grade or "enhanced plastic." Only products designated by TI as military-grade meet military specifications. Buyers acknowledge and agree that any such use of TI products which TI has not designated as military-grade is solely at the Buyer's risk, and that they are solely responsible for compliance with all legal and regulatory requirements in connection with such use.

TI products are neither designed nor intended for use in automotive applications or environments unless the specific TI products are designated by TI as compliant with ISO/TS 16949 requirements. Buyers acknowledge and agree that, if they use any non-designated products in automotive applications, TI will not be responsible for any failure to meet such requirements.

Following are URLs where you can obtain information on other Texas Instruments products and application solutions:

Products

Audio	www.ti.com/audio
Amplifiers	amplifier.ti.com
Data Converters	dataconverter.ti.com
DLP® Products	www.dlp.com
DSP	dsp.ti.com
Clocks and Timers	www.ti.com/clocks
Interface	interface.ti.com
Logic	logic.ti.com
Power Mgmt	power.ti.com
Microcontrollers	microcontroller.ti.com
RFID	www.ti-rfid.com
OMAP Mobile Processors	www.ti.com/omap
Wireless Connectivity	www.ti.com/wirelessconnectivity

Applications

Communications and Telecom	www.ti.com/communications
Computers and Peripherals	www.ti.com/computers
Consumer Electronics	www.ti.com/consumer-apps
Energy and Lighting	www.ti.com/energy
Industrial	www.ti.com/industrial
Medical	www.ti.com/medical
Security	www.ti.com/security
Space, Avionics and Defense	www.ti.com/space-avionics-defense
Transportation and Automotive	www.ti.com/automotive
Video and Imaging	www.ti.com/video

TI E2E Community Home Page

e2e.ti.com

Mailing Address: Texas Instruments, Post Office Box 655303, Dallas, Texas 75265
Copyright © 2011, Texas Instruments Incorporated