

## Classic 5¼" Woofer

Type Number: TC14WG49-04

### Features:

The Classic line consists of all the highly regarded transducers that have been appraised and loved by so many customers over the years. The goal has been to assemble all the diamonds, developed over the years, speakers that fully live up to the heritage of the brand.

Driver Highlights: 5½" midwoofer, polymer-chassis, coated paper cone, NRSC cone



### Specs:

#### Electrical Data

Nominal impedance	Zn	4	ohm
Minimum impedance	Zmin	--	ohm
Maximum impedance	Zo	--	ohm
DC resistance	Re	3.1	ohm
Voice coil inductance	Le	0.45	mH

#### T-S Parameters

Resonance Frequency	fs	52	Hz
Mechanical Q factor	Qms	2.79	
Electrical Q factor	Qes	0.44	
Total Q factor	Qts	0.38	
Force factor	Bl	4.3	Tm
Mechanical resistance	Rms	--	Kg/s
Moving mass	Mms	8.1	g
Suspension compliance	Cms	--	mm/N
Effective cone diameter	D	--	cm
Effective piston area	Sd	80	cm <sup>2</sup>
Equivalent volume	Vas	10.5	ltrs
Sensitivity (2.83V/1m)		87	dB
Ratio BL/√(Re)		--	
Ratio fs/Qts	F	--	

#### Power handling

100h RMS noise test (IEC)	--	W
Long-term Max Power (IEC 18.3)	110	W
Max linear SPL (rms) @ power	--	dB/W
Short Term Max power (IEC 18.2)	110	W

#### Voice Coil and Magnet Parameters

Voice coil diameter	25	mm
Voice coil height	10	mm
Voice coil layers	--	
Height of the gap	4	mm
Linear excursion +/-	--	mm
Max mech. excursion +/-	--	mm
Flux density of gap	--	mWb
Total useful flux	--	mWb
Diameter of magnet	--	mm
Height of magnet	--	mm
Weight of magnet	0.24	Kg

Notes:  
IEC specs refer to IEC 60268-5 third edition.  
All Tymphany products are RoHS compliant.

Frequency: TC14WG49-04

SPL [dB]

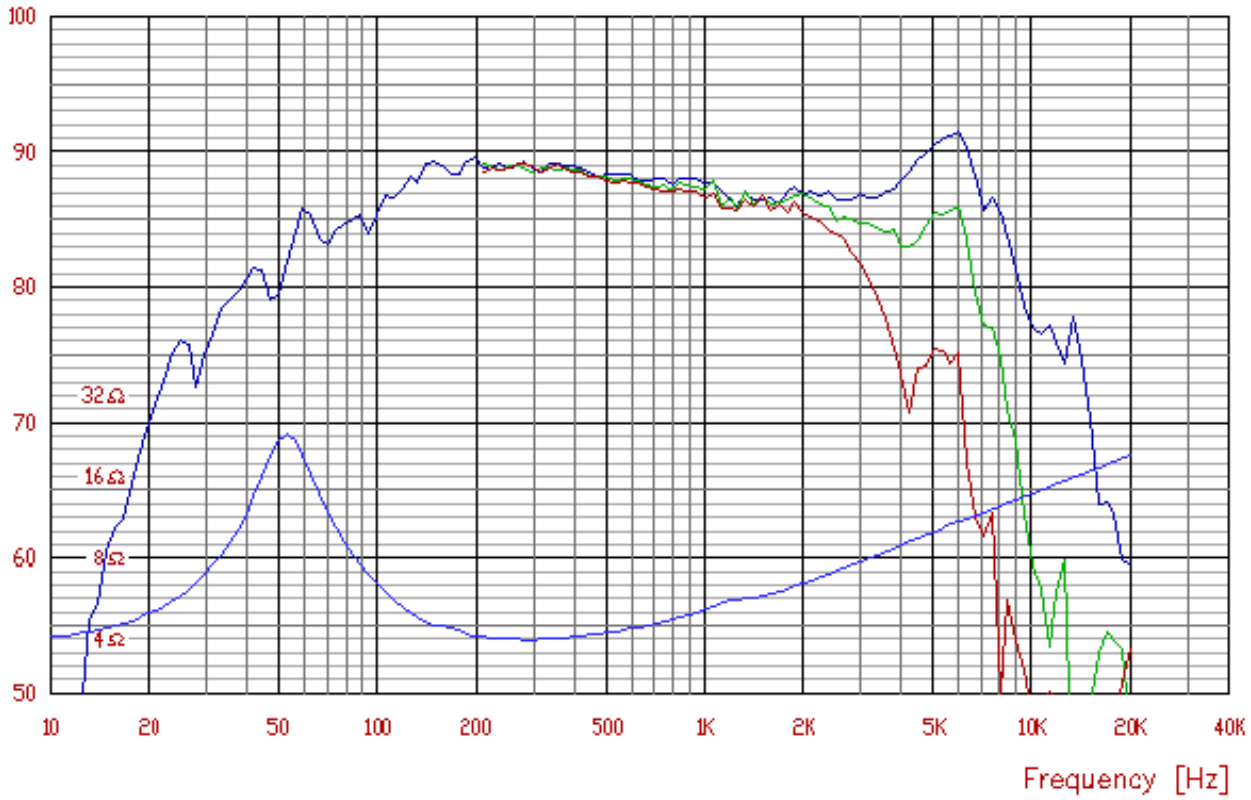

Mechanical Dimensions: TC14WG49-04

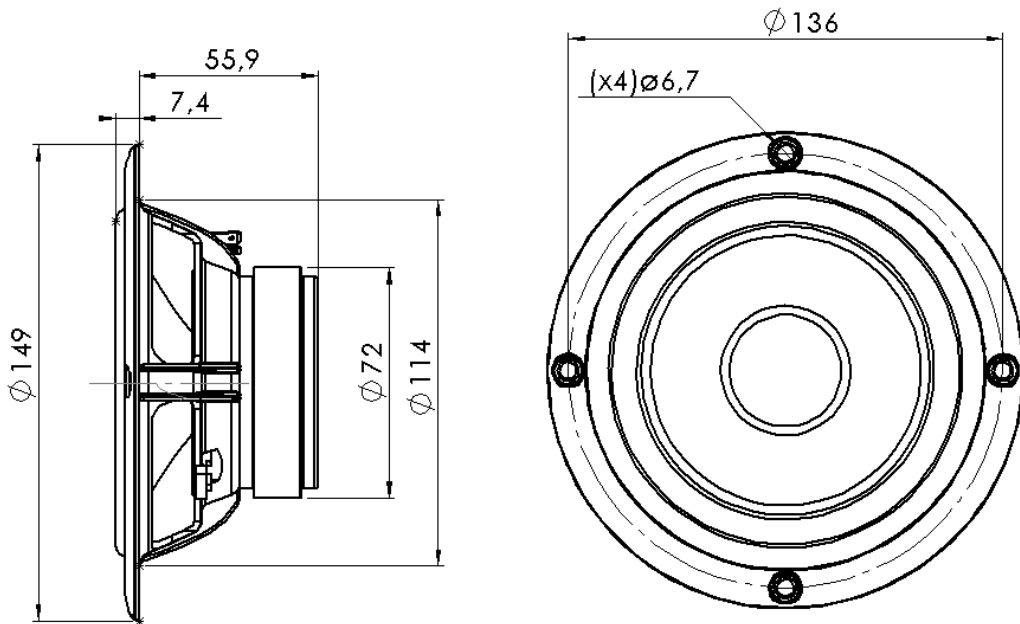

TC14WG49-04